

Copyright © 2001 Corel Corporation. All rights reserved.

Bryce® User Manual - ver 5.0

The contents of this manual and the associated Bryce software are the property of Corel Corporation, Corel Corporation Limited and their respective licensors, and are copyrighted. Any reproduction in whole or in part is strictly prohibited. For more complete copyright information, please refer to the Readme.txt file in the root directory of the software.

Bryce, the "Powerful 3D Landscaping and Animation" byline, the Corel logo, AnswerPerfect, Corel PHOTO-PAINT and Painter are trademarks or registered trademarks of Corel Corporation or Corel Corporation Limited in Canada, the United States and/or other countries. Adobe and Photoshop are registered trademarks of Adobe Systems Incorporated. Microsoft, Direct 3D, Windows and Windows NT are registered trademarks of Microsoft Corporation in the United States and/or other countries. Apple, Mac, and Macintosh are registered trademarks of Apple Computers, Inc. QuickTime is a trademark used under License. QuickTime is registered in the U.S. and other countries. Netscape Navigator is a registered trademark of Netscape Communications Corporation. AutoCAD is a registered trademark of Autodesk, Inc. OpenGL is a registered trademark owned by Silicon Graphics, Inc. Other product, font, and company names and logos may be trademarks or registered trademarks of their respective companies.

005041

CONTENTS

WELCOME TO BRYCE

Corel support and services	2
Installing Bryce	3
What is Bryce?	4
What's New in Bryce	4
Using Bryce Help	6
Bryce Terms	7
Exploring the work area	8

GETTING STARTED

Working with documents	18
Using the basic features of Bryce	19
Working in a Scene	19
Saving and Closing	24
Setting Application Preferences	25
Customizing Bryce	29

TUTORIAL

Getting Started	32
Arranging Objects in the Scene	33
Creating the Sky	36
Creating a Body of Water	36
Creating a vaulted roof	40
Building the Walls	44
Group and Grow the Entire Building	48
Sphere on a Pedestal	50
Pre-Production	51
Animate the Camera	53
Fine-Tuning Your Animation	59
Final Comments	61

CREATING OBJECTS

The Create Palette	64
Primitives vs. Procedural Objects	64

Creating Primitives	65
Object Placement	65
Selecting Objects	65
Objects in the Scene	69
Creating Boolean Objects	72
Using the Presets Object Library	75
Creating Infinite Planes	77
Creating Terrains	79
Creating Trees	79
Creating Stones	80
Creating Symmetrical Lattices	80
Creating Metaballs	81
Creating a Pict Object	81
Working with Pictures	83
Creating Geometric Paths	88
Importing Objects	89

Editing TERRAINS

Creating Terrains	92
The Terrain Editor workspace	93
Using Terrain Editor Tools	96
Using the paintbrush	106
Filtering Terrains	107
Using Creation Models	111
Creating Terrains Using Pictures	111
Adding Color to Terrains	113
Clipping Terrains	114
Saving Terrains	115
Exporting Terrains	115

Editing TREES

Working with the Tree Lab	120
Features of the Tree Lab	121
Tree Preview	121
Branch/Trunk Settings	122
Tree Settings	123
Foliage Settings	124

Applying MATERIALS

Material Structure	128
Surface Material Channels.	133
Volume Material Channels	142
Material Components	144
Using the Pictures Editor	147
Shading Modes	155
The Materials Lab	160
Working in the Materials Lab	162
Material Presets	164

CREATING AND EDITING TEXTURES

Texture Structure	170
Component Output	172
Component Elements	174
Combining Components	192
The Deep Texture Editor	196
Working in the Deep Texture Editor	197
Tips for Speeding Up Textures	199

ARRANGING OBJECTS

Bryce and 3D Space.	202
Coordinate Systems	204
Transforming Objects	206
Resizing Objects	208
Rotating Objects	212
Positioning Objects	214
Aligning Objects	216
Randomizing Objects	220
Object Hierarchies	221

EDITING OBJECTS

Restoring Objects	230
Editing Object Attributes	230
Editing Toruses	237
Editing Imported Meshes and Stones.	238
Converting Objects	239

CREATING SKIES

The Sky&Fog Palette	242
Working with Sky Modes	245
Setting Sky Attributes.	246
Adding Fog and Haze	248
Clouds in Bryce	253
Working with the Sun	260
Working with the Moon	263
Adding Environmental Effects.	266
Using the Preset Skies Library.	270

CREATING AND EDITING LIGHTS

Lights	274
Setting Up Lights	275
Lighting Lab	278

USING THE CAMERA

The View of Your Scene	288
Setting Up the View of Your Scene.	288
Positioning the View of Your Scene	291

RENDERING

Raytracing	302
Rendering a Scene	302
Setting Up a Render	305
Rendering Animations.	311
Network Rendering.	312
Batch Rendering	315
Fast Render Strategies	315
Working with Rendered Images	316

ANIMATING

The Animation Process	320
Time-Based Animation	320
Creating Animations	321
Animation Tools	322
Motion Paths.	330

Animation Features.....	340
Animating Techniques	343
Tracking Objects	344
Animating the Camera	346
Animating Materials	350
Animating Skies	354
Animating Terrains.....	357
QuickTime VR	361
Creating QuickTime VR Panoramas	361

Using Bryce with Other Applications

Working with Other Applications	364
Post Production.....	365
Printing Images.....	368
Using Bryce on the Web	368

Glossary

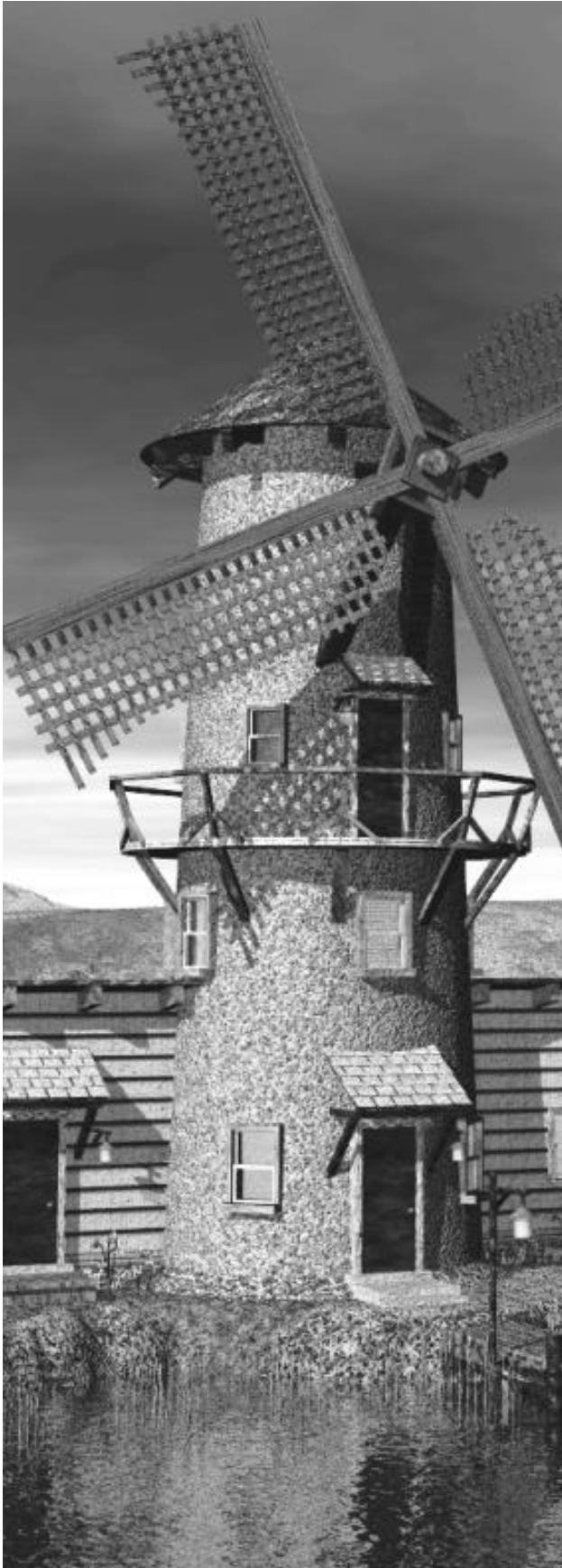

1

WELCOME TO BRYCE

Welcome to Bryce® 5, the leading 3D program for desktop artists, animators, Web designers, and multimedia producers. Bryce is ideal for creating 3D graphics for magazines, ads, or virtually any illustration that would benefit from the powerful 3D impact of realistic perspective and shading.

Bryce animation features let you create great animations for video and multimedia easily. Bryce key-event and timeline-based animation lets you create incredibly realistic, fully animated, 3D worlds where rivers rush through gorges, the sun sets over the ocean, or mist evaporates to reveal flocks of birds soaring between mountain peaks.

Bryce is also an invaluable tool for interactive multimedia.

COREL support AND SERVICES

Corel is committed to providing quality customer service and support that is easy to access and convenient to use, while fostering one-to-one customer relationships.

If you have a question about the features and functions of Corel applications or operating systems, see the user manual or online Help for the product you are using. Updates and technical information are also available in the Release Notes.

REGISTERING COREL PRODUCTS

Registering Corel products is important. Registration provides you with timely access to the latest product updates, valuable information about product releases and access to free downloads, articles, tips and tricks, and special offers.

For more information about registering a Corel product see the online Help for the product or see <http://www.corel.com/support/register> on the Internet.

TECHNICAL SUPPORT

The Web address for Corel is <http://www.corel.com> on the Internet. A list of localized Corel Web sites is available at <http://www.corel.com/international/country.htm> on the Internet. Corel LINUX® information is available at <http://linux.corel.com> on the Internet.

SELF-SERVE TECHNICAL SUPPORT OPTIONS

Several self-serve tools are available to address technical questions 24 hours a day, seven days a week.

SUPPORT NEWSGROUPS:

<http://www.corel.com/support/newsgroup.htm>

COREL® KNOWLEDGE BASE

<http://kb.corel.com>

FAQs

<http://www.corel.com/support/faq>

ANSWERPERFECT™

<http://www.corel.com/support/answerperfect.htm>

FILE TRANSFER PROTOCOL (FTP)

<ftp://ftp.corel.com>

FTP INFORMATION

<http://www.corel.com/support/ftpsite/ftpindex.htm>

ONLINE HELP

Type keyword Technical Support

AUTOMATED FAX ON DEMAND*

1-877-42-COREL

*Fax on Demand is available only in North America.

TELEPHONE TECHNICAL SUPPORT OPTIONS

Corel users can use complimentary and fee-based telephone technical support options. Three levels of support are available.

CLASSIC SERVICE

Classic Service is a complimentary, 30-day service designed to address installation, configuration, and new feature issues. This service begins on the day of your first technical support call.

Classic Service is a paid for service for OEM, "White box," Jewel Case (CD only), trial, or Academic versions of Corel products.

PRIORITY SERVICE

Priority Service is a fee-based service for users who require the help of second-level technicians. Priority Service may be purchased by the minute, by the incident, or on a term basis. Options range

from core-business-hour access for individual users to around-the-clock access for multiuser environments.

PREMIUM SERVICE

Premium Service is Corel's highest level of support. This service is designed for organizations that want to establish a direct relationship with Corel and for organizations that employ dedicated support professionals or have centralized technical management.

CUSTOMER SERVICE

Corel Customer Service can provide you with prompt and accurate information about Corel product features, specifications, pricing, availability, and services. Corel Customer Service does not provide technical support. You can access Customer Service support through the following avenues.

World Wide Web

You can access general customer service and product information at <http://www.corel.com/> support on the Internet.

Mail, fax, email

You can send specific customer-service questions to Corel Customer Service representatives by mail, fax, and email.

Corel Corporation
Corel Customer Service
1600 Carling Avenue
Ottawa, Ontario
Canada K1Z 8R7

Fax: 1-613-761-9176

Email: custserv2@corel.ca

TELEPHONE

You can telephone Corel Customer Service centers with your questions.

In North America, you can reach Corel Customer Service by calling the 1-800-772-6735 toll-free line. The hours of operation are 9:00 a.m. to 9:00 p.m., eastern time (ET), Monday through Friday, and 10:00 a.m. to 7:00 p.m. on Saturdays.

Corel customers outside North America can call a local authorized Corel Customer Service Partner.

INSTALLING BRYCE

Your Bryce package includes:

- the Bryce CD-ROM
- the Bryce Content CD-ROM
- the Bryce User Manual
- your Bryce serial number
- a software registration card

If you are missing any of these items, please contact your Bryce dealer/distributor or Corel Customer Service.

To install Bryce for Windows®

- 1 Close all applications.
- 2 Insert the Bryce CD-ROM into the CD-ROM drive. The Corel setup wizard should start automatically.

If the Corel setup wizard does not start automatically, click Start on the Windows taskbar, and click Run. Type X:\setup, where X is the letter that corresponds to the CD-ROM drive.

- 3 Follow the instructions in the Corel setup wizard.

To uninstall Bryce for Windows

- 1 Click Start on the Windows taskbar, and click Programs>Bryce>Uninstall Bryce.

- 2 Follow the instructions on your screen.

To install Bryce for Macintosh®

- 1 Close all applications.
- 2 Insert the Bryce CD-ROM into the CD-ROM drive.
- 3 Double-click the Bryce installer to start the installation.
- 4 Follow the instructions on your screen.

To uninstall Bryce for Macintosh

If you created presets that you want to use again, make sure you save your presets to another location before following this procedure.

- Drag the Bryce folder to the Trash.

REGISTERING COREL PRODUCTS

Registering Corel products is important. Registration provides you with timely access to the latest product updates, valuable information about product releases, and access to free downloads, articles, tips and tricks, and special offers.

For more information about registering a Corel product, see the online Help for the product, or see <http://www.corel.com/support/register/> on the Internet.

WHAT IS BRYCE?

Bryce is a stand-alone application that allows you to create and animate three-dimensional virtual environments.

With Bryce you can create any type of environment you can envision, from the ivory beaches of Tahiti to the silvery rings of Saturn. Bryce user interface contains all the tools you'll need to create your environments.

For example, Bryce includes controls for managing infinite skies that let you set everything from time of day to the color and frequency of clouds. Using the sky controls, you can also set light direction, sun/moonlight, atmospheric depth haze (with intensity and color), height fog (with height, intensity, and color), and multiple sky color components.

You can also use Bryce controls to create a wide variety of objects you can use to populate your environment. You can use the Terrain editor to create an infinite number of custom terrains, which you, in turn, use to create landscapes.

The realism of a Bryce environment largely depends on the materials applied to the objects in the scene. Materials are complex combinations of textures and values. The Materials Lab lets you combine textures and channel values that simulate any material found in the real world (and a few that aren't!).

When you have set up your environment just the way you want it, you can add a fourth dimension—time. You can use Bryce's animation tools to set up landscapes that move and materials that change over time.

WHAT'S NEW IN BRYCE

Bryce5 has new tools, features, and improvements over Bryce 4. This overview provides a head start on locating, learning about, and taking advantage of new features in Bryce. They include:

NETWORK RENDERING

The new Network Rendering feature in Bryce lets you spread a rendering job over multiple computers. This reduces the amount of time required to render a complex scene or animation.

With Network Rendering, Bryce can use the computing power of any computer running Bryce or Bryce® Lightning and connected by a TCP/IP

network to render a scene or animation in a fraction of the time. Refer to “Network Rendering” on page312 for more information.

NEW LIGHT LAB

The Light Lab provides new and improved tools for editing lights. The redesigned Light Lab makes it easier to adjust lights as all the controls are now conveniently placed in a single location.

The new gradient feature lets you add a color gradient to lights. When a light has a gradient applied, the color and intensity of the light is determined by the distance the light travels and the gradient that has been applied. You can create your own gradients and save them for future use, or import gradients from Corel PHOTO-PAINT® or Adobe® Photoshop®.

Other new lighting options include Shadow Ambience, Soft Shadows, and premium rendering effects like Blurry Reflections, Blurry Transmissions, and True Ambience. Refer to “Lights” on page274 for more information on the Light Lab.

TREE LAB

The new Tree Lab lets you create tree objects in a scene. You can control the size and texture of the tree trunk, the thickness and number of branches, the type of foliage and its frequency, randomness, and color. You can import images to be used for the trunk or foliage texture. You can also control how gravity affects the tree, making branches bend and leaves droop to varying degrees. Refer to “Editing Trees” on page119 for more on the new Tree Lab.

METABALLS

Also new to Bryce are Metaballs, a new object type found on the Create palette. Metaballs are spheres that blend into each other based on proximity. With Metaballs, you can create a wide variety of

organic and realistic-looking shapes. Refer to “Creating Metaballs” on page81 for more on the new Metaballs feature.

ENHANCED USER INTERFACE

To enhance ease of use, the user interface in Bryce has been enhanced in a number of ways. For example, the Terrain editor has been redesigned to give you more control when painting effects, to let you create more detailed terrains, and to provide larger previews and animated previews of the resulting terrains. The animation playback controls have been streamlined to make them easier to use. The Create palette has also been simplified to make it easier to find the object you want. In addition, two new object types have been added to the Create Palette: Metaballs and Trees.

...AND MUCH MORE

Bryce also includes the following new features:

- partial shadows for objects with volume materials
- shadow ambience for lights
- new 3D Grid spatial optimizer
- new terrain grid resolutions: Gigantic (2048), and Planetary (4096)
- support for distributed rendering effects for lights, including soft shadows, blurred reflections, blurred transmissions, depth of field, and true ambience
- support for Total Internal Reflection (TIR)
- enhanced Render dialog
- volume shading mode
- volume materials shading mode
- uniform density shading
- five new mapping modes: Sinusoidal, World Front, World Side, World Cubic, and Object Cubic
- new Sky Integration feature
- distance squared texture noise & phase type

- earth-based starfields and comets
- new import and export filters and plug-ins

Using Bryce Help

Bryce has several tools that help you work with the application:

- User manual — lets you access Bryce concepts and procedures in a paper format, and includes a tutorial to help you get started quickly
- Online documentation — lets you access Help directly from the user interface and find topics using the contents, index, and word/phrase search tool
- CoreITUTOR™ — lets you follow step-by-step tutorials that teach you how to perform common tasks in Bryce

To use online Help

- 1 Choose Help menu > Help topics.
- 2 Click one of the following tabs:
 - Contents — lets you choose a topic from a section of the online Help
 - Index — lets you use the index to find a topic
 - Search — lets you find a topic by searching for a particular word or phrase in the online Help

You can also print a Help topic by opening a Help topic and clicking Print.

To use CoreITUTOR™:

- 1 Choose Help menu > CoreITUTOR™.
- 2 Choose a tutorial from the list and follow the directions on your screen.

About Your User Manual

The user manual provides all the information you need to get the most out of Bryce. It will help you learn the application as well as serve as a reference as you attempt more sophisticated procedures and effects.

We assume you are already familiar with basic Macintosh and Windows concepts such as menus, dialogs, and mouse operations. If you need more information on these subjects, or on the Macintosh Finder or the Windows Desktop, refer to the Macintosh User's Manual or the Microsoft Windows User's Guide, respectively.

The best way to learn Bryce is by reading "Exploring the work area" on page 8 and "Getting Started" on page 17, and then completing the "Tutorial" on page 31. The tutorial leads you through the process of creating illustrations in Bryce and explains some of the important concepts you'll need to know.

Conventions

The Bryce User Manual and online Help are written for both Macintosh and Windows. By convention, Macintosh commands precede Windows commands in the text. For example, Command/Ctrl+I, is equivalent to the Macintosh Command-I and the Windows Ctrl+I. For simplicity, the term *folder* refers to directories as well as folders. Screenshots may alternate between the Macintosh and Windows versions. The Bryce interface for both platforms is identical, unless otherwise specified.

There are also several conventions used to identify paths to certain tools and controls. The convention used to tell you to access a command in a menu is menu name > menu item. The convention used to tell you to access an item on a palette is palette name: subpalette name or palette item. The convention used to tell you to access a palette menu item is palette name: palette menu > menu item.

Modifier Keys

When a modifier key differs between the Macintosh and Windows platforms, the Macintosh modifier is listed first followed by a slash and the Windows modifier key. Option/Alt means Macintosh users press the Option key and Windows users press Alt.

BRYCE TERMS

Computer graphics and three-dimensional modeling use special terms that are usually explained where they are introduced. The "Glossary" on page 371 provides concise definitions of a number of terms.

Before you get started in Bryce, you should be familiar with the following terms.

Scene — a) The complete content of your Bryce world; b) the two-dimensional screen projection of your 3D scene; c) the file that Bryce saves, containing all information regarding your landscape.

Object — An independent element that you can modify. Objects include shapes, terrains, planes, symmetrical lattices, and pictures.

Wireframe — A mesh representation of a 3D object.

Render — The complex process of building a two-dimensional bitmapped image from all the information contained in your three-dimensional wireframe scene.

Palette — A collection of related tools.

EXPLORING THE WORK AREA

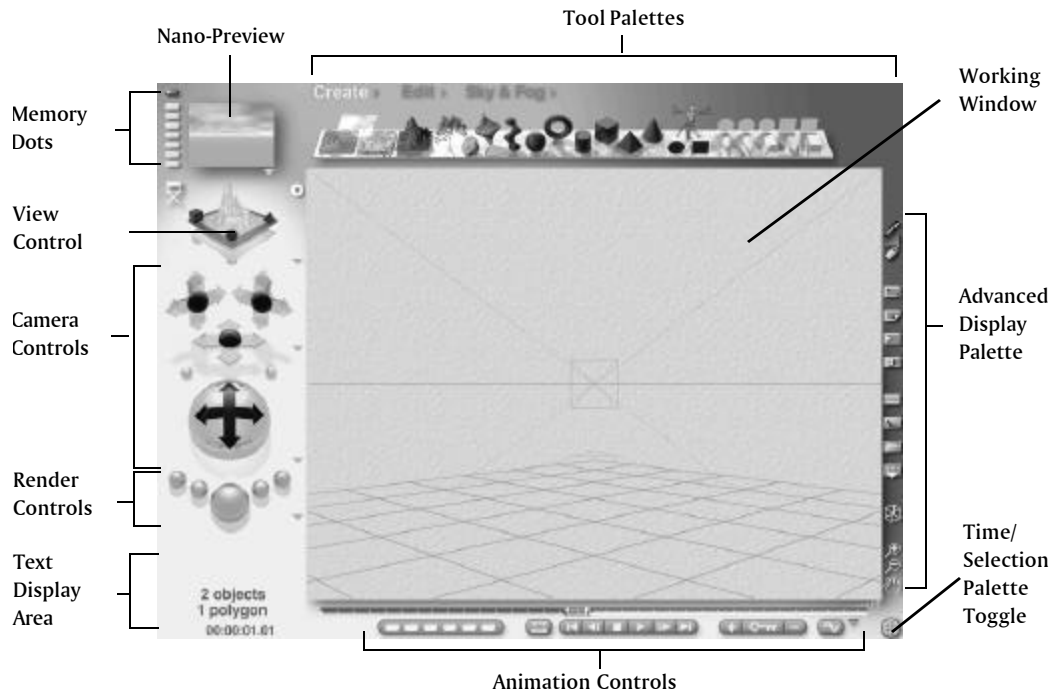

THE BRYCE WINDOW

Bryce's default environment consists of the Working window, the Control palette, and the Tool palettes.

By default, the Bryce environment replaces your screen whenever you launch the application. However, your operating system's standard menus and windows are still available from within Bryce.

THE WORKING WINDOW

The Working window displays all the objects in your Bryce scene. It's the work area where you'll arrange the objects and lights to create your environment.

The view of your scene shown in the Working window is taken from a "camera" that you can move around for different views of your scene. The Working window also has several display modes that let you view a scene as a wireframe, a rendered object, or a combination of both. Refer to "Display Modes" on page 26 for more information.

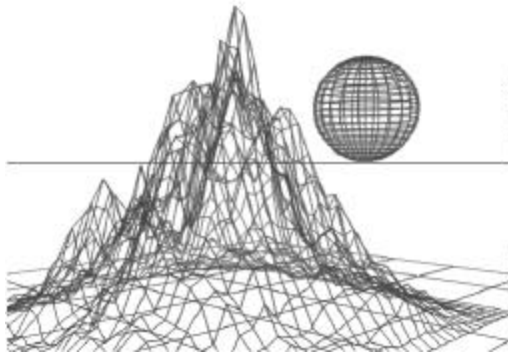

The Working window displays all the objects that make up your scene.

NANO-PREVIEW

The Nano-Preview displays a rendered preview of your scene. As you update your scene, Nano-Preview shows your changes. You can immediately see how your adjustments to object position or other properties affect the final look of the scene.

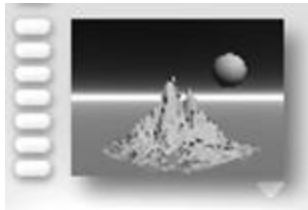

The Nano-Preview shows a small rendered version of your scene. As you change the scene, the display updates to show your changes.

You can use the preset viewing positions to see your scene from different angles, or you can use the Memory Dots to store and retrieve your favorite camera positions. Refer to “Using the Nano-Preview” on page 19 for more on working with the Nano-Preview.

VIEW CONTROL

View Control lets you adjust the view of your scene without moving the camera. Using this control you can see your scene from the top, bottom, left, right, front, or back. You can also set your scene to continuously rotate so you can see it from any angle. Refer to “Using the View Control” on page 20 for more on using the View Control

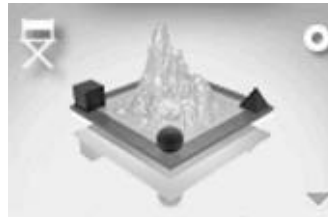

The View Control lets you control how you see your scene.

CAMERA CONTROLS

Camera Controls change the position of the camera specifically along the X, Y, and Z axes. The Camera Trackball lets you move the camera in any direction, and along any axis.

Refer to “Using the Camera” on page 287 for more on moving the camera.

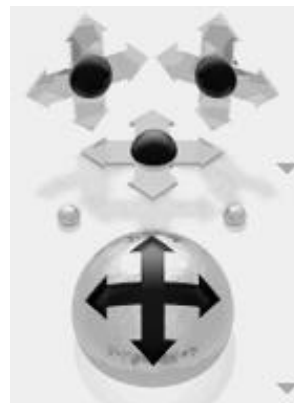

The Camera controls let you adjust the position of the camera.

RENDER CONTROLS

Render Controls let you render your scene to see all the materials and lighting effects you added. The center button starts the rendering process and the other buttons control rendering options. Refer to “Rendering” on page301 for more on rendering.



The Render controls let you render your scene as a 2D image.

TEXT DISPLAY AREA

The area just below the Render Controls is reserved for momentary display of text information. When you pass your pointer over interface elements, this area displays the name of the interface element, and in some cases, it also displays the element’s current settings. The Text Display Area also displays information about the total number of polygons in an object or a scene, and information about current control settings.

To display information about the interface:

- Pass the pointer over any interface element.
The name of the element is displayed. In some cases, the element’s current settings are also displayed.

To display statistics about the objects in your scene:

- 1 Switch to Wireframe display using the Display Mode tool.
- 2 Pass the pointer over the Working window.
 - If no objects are selected, the Text Display area displays a count of all of the objects in your scene, as well as a total polygon count.

- If an object is selected, the Text Display area displays object and polygon counts for the selected object.

To display information about rendered images:

- 1 Switch to Bitmap display using the Display Mode tool.

If you have not rendered your image, the Working window is blank.

- 2 Pass the pointer over the Working window.
The Text Display area shows the file size.

THE PALETTES

Bryce uses a series of palettes to manage tools and controls—the Create palette, Edit palette, Sky & Fog palette, Advanced Display palette, Selection palette, and Animation controls. These palettes let you create objects, edit objects, create skies and fog, control the display of your scene, select objects, and animate objects.

Beside the title of each of the three tool palettes (the Create palette, Edit palette, and Sky & Fog palette) is a small triangle that opens the different Preset Libraries available in Bryce. Refer to “The Bryce Preset Libraries” on page15 for more on Preset Libraries.

THE CREATE PALETTE

The Create palette contains tools for creating infinite planes, terrains, stones, primitive shapes, derivative primitives, 2D picture objects, and lights. Refer to “The Create Palette” on page64 for more on the Create palette.

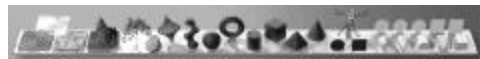

The Create palette contains tools for creating all the types of objects you can use in a Bryce scene.

THE EDIT PALETTE

The Edit palette contains tools for editing object materials and resizing, rotating, repositioning, aligning, and randomizing objects. Refer to “Transforming Objects” on page206 for more on the Edit palette.



The Edit palette contains tools for transforming objects and accessing the Editors.

THE SKY & FOG PALETTE

The controls available on the Sky & Fog palette let you add shadows, fog, and haze, and let you set the altitude, frequency, and amplitude of clouds. The Sky & Fog palette also lets you control the color of clouds in your sky and the position of the sun and moon. Refer to “The Sky&Fog Palette” on page242 for more on the Sky & Fog palette.

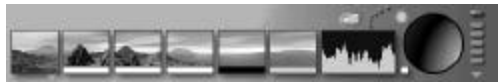

The Sky & Fog palette contains tools for creating the atmosphere of your Bryce scene.

ADVANCED DISPLAY PALETTE

The Advanced Display palette contains tools for controlling the display of the interface and enabling/disabling the Nano-Preview and Plop Render features. The Advanced Display appears on the right side of the Working window. Refer to “Setting Up the Bryce Window” on page25 for more on using the Advanced Display palette tools.



The Advanced Display palette contains tools for changing the Working window display.

SELECTION PALETTE

The Selection palette contains tools for selecting specific types of objects in your scene. You do not see this palette in the default Working window. To view it, you must use the Time/Selection Palette toggle at the far bottom right of your Working window to replace the Animation controls with the Selection palette. Refer to “The Selection Palette” on page66 for more on selecting objects.



The Selection palette contains tools that let you select objects in your scene

THE ANIMATION CONTROLS

The Animation controls let you set up key frames and edit the timeline of your animation. These controls also let you preview your animation, add and delete key frames, and access the Advanced Motion Lab. Refer to “Setting Up an Animation” on page321 for more on using the Animation controls.

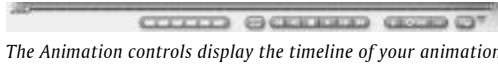

Displaying/Hiding PALETTES

To keep the interface uncluttered, many of Bryce palettes and toolbars are hidden when you first launch the application. Some palettes are hidden behind other palettes.

To display PALETTES:

- Either click on a text button above the Working window, or press the key combination for the desired palette:
 - Control/Ctrl+1=Create palette
 - Control/Ctrl+2=Edit palette
 - Control/Ctrl+3=Sky & Fog palette
 - Control/Ctrl+4=Control palette
 - Control/Ctrl+6=Advanced Display palette

To display or hide ALL PALETTES:

- Press Control/Ctrl+Tab.

Displaying SUBMENUS AND POP-UP DIALOGS

Wherever you see an inverted or sideways triangle icon in the interface, it indicates that there is a menu or other item available that contains options pertinent to the item closest to it. For example, in the Create palette, there are triangle icons next to each tool in the palette. These triangles access the additional options for the tools.



The triangle icon next to a tool or text button indicates that there are more options available for the element.

To display A SUBMENU:

- Click the triangle icon.

THE MENU BAR

The Bryce menu bar contains five menus: the File menu, the Edit menu, the Objects menu, the Links menu, and the Help menu. These menus provide access to several Bryce functions and editors.

The display of the menu bar depends on the state of the application. When the application interface snaps to the edges of your Working window, the menu bar is hidden until you pass the pointer over the menu bar area at the top of the Bryce window.

THE EDITORS

Bryce has several editors that let you do everything from creating terrains to editing the speed of animation. Each editor is like a separate room in Bryce. When active, the editor takes over the interface, completely replacing the Working window.

THE TERRAIN EDITOR

The Terrain Editor is where you'll create all the terrain objects in your scene. The editor contains tools for painting and refining terrain objects. The Terrain Editor also has a real-time preview so you can see the effects of your changes instantly. Refer to "Creating Terrains" on page 92 for more on the Terrain Editor.



The Terrain Editor lets you create any type of landscape using the preset tools and paint brush.

THE MATERIALS LAB

The Materials Lab is where you'll create the materials to apply to your objects. By combining up to four texture components on the materials grid, you can create incredibly complex surfaces that can bring your scene to life.

There are two types of materials you can create: Surface materials, which define the surface properties of an object, and Volume materials, which define the properties of an object's volume as well as its surface. When you're creating volume materials, the settings in the Materials Lab change. Some of the surface material settings are replaced by volume effects settings. Refer to "The Materials Lab" on page 160 for more on the Materials Lab, and "Understanding Volume Material Channels" on page 130 for more on Volume materials.



The Materials Lab lets you create different types of materials by combining texture components on the materials grid.

THE ADVANCED MOTION LAB

The Advanced Motion Lab lets you fine-tune your animations. After you've created your key frames using the Animation controls, you can use the tools available in this lab to control the speed at which objects move along a motion path, adjust the position of key frames, and preview your changes. Refer to "The Advanced Motion Lab" on page 334 for more on animating scenes and using the Advanced Motion Lab.

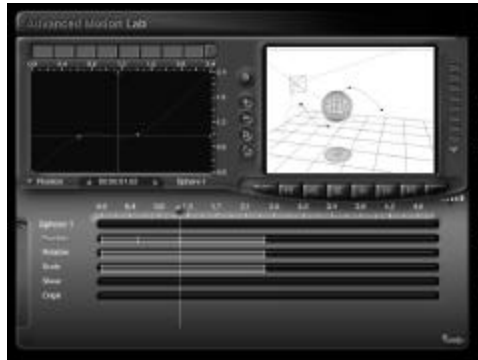

The Advanced Motion Lab lets you refine the action in your animations. Use the Velocity Curve editor to create different velocity effects and the Hierarchy area to control when object transformations occur.

ADJUSTING EDITOR SETTINGS

The editors have unique interfaces that let you adjust individual settings by using a variety of tools, including controls, fields, knobs, and component indicators. To get the most out of each editor, it is important to know how these elements work.

USING CONTROLS

Controls let you set a value for an element within an editor. For example, in the Sky Lab, the Cloud Cover control lets you set the amount of clouds in your scene.



Controls are comprised of a slider and a field. Controls are used to set values.

TO ADJUST THE VALUE OF A CONTROL USING THE SLIDER:

- Slide the highlighted portion of the control to the left or right.

USING FIELDS

Fields can be found in dialogs and in controls. A field lets you enter a precise numerical value.

TO ADJUST THE VALUE OF A FIELD:

- Click in the field and type a value.



A field located in a control.

TO ADJUST THE VALUE OF A CONTROL USING A FIELD:

- 1 Click the numerical value to the right of the control's slider. The field will appear.
- 2 Click in the field and type a value.

USING KNOBS

Some of the editors in Bryce contain knobs. Knobs can perform many different functions, such as randomizing or saving elements. To activate the knob's function, click the knob.



Knobs can perform many different functions. To activate a knob's function, click the knob.

USING COMPONENT INDICATORS

Some of the editors contain component indicators. When you are combining several components to create a composite element, such as a texture, the component indicator lets you know which component you are currently manipulating.



Component indicators let you know which component you are currently editing. In the image above, the first component is active.

When working with materials, you can blend material components by turning on multiple component indicators simultaneously. Refer to “Combining Components” on page154 for more on using the component indicators to blend material components.

To TURN A COMPONENT INDICATOR ON OR OFF:

- Click the component indicator.

THE BRYCE PRESET LIBRARIES

Bryce has several libraries of presets that can make creating scenes easier. There are three main preset Libraries available in Bryce: the Preset Objects Library, the Preset Materials Library, and the Preset Skies Library.

You can use the Preset Objects Library to add ready-made objects to your scene. Refer to “Using the Presets Object Library” on page75 for more on the Preset Objects Library.

The Preset Materials Library lets you add a wide variety of materials to your objects. Refer to “Using the Materials Presets Library” on page164 for more on the Preset Materials Library.

The Sky & Fog Preset library contains pre-made skies that you can add to your scene to quickly create an environment. Refer to “Using the Preset Skies Library” on page270 for more on the Preset Skies Library.



2

GETTING STARTED

Scenes are the three-dimensional images that you create and animate in Bryce. In this section, you'll learn about

- starting and opening scenes
- using the basic features of Bryce
- viewing scenes
- positioning the camera
- undoing and redoing operations
- saving scenes
- closing scenes and quitting Bryce
- setting application preferences
- customizing the Bryce interface

WORKING WITH DOCUMENTS

Before you can create a Bryce environment you need a document. A document can be either a blank scene or an existing file that you're going to edit.

CREATING AN EMPTY SCENE

When you create a blank scene, Bryce opens the Document Setup dialog which lets you specify the aspect ratio and dimensions of the new scene.

TO CREATE A NEW DOCUMENT:

- 1 Choose File menu > New. The Document Setup dialog appears.
- 2 Enter values in the Document Resolution fields.

This is the absolute size of your working space expressed in pixels. You can enter any values you like here, though it's recommended that you do not exceed your available screen space if you can avoid it. You can work small and render large if you need to. The values in the Aspect Ratio fields will update automatically as needed.
- 3 Enter values in the Document Aspect Ratio fields.

These fields represent the Document Resolution as a ratio. Depending on the type of work you are doing, it may be more convenient to enter values here rather than in the resolution fields above. For instance, many video formats, as well as the standard 13" screen, are 3:4 aspect ratios.

The values in the Document Resolution fields will update automatically if you change the aspect ratio.
- 4 Enable the Constrain Proportions button if you want to preserve the current aspect ratio as you adjust the resolution.
- 5 Select a Render Resolution from the list.

This resolution sets the absolute size of your rendered image, expressed in pixels as a multiple of your document size.

You can work in one size as you build your scene and render that scene in a different size. For example, you could be working at Bryce's default size but need to render four times larger for print or four times smaller for a Web page. Rather than resetting your document resolution every time you render (thereby impacting your wireframe workspace), you can simply set a separate size for rendering. Think of Document Resolution as input, and Render Resolution as output.

The default resolution is 540 x 405, and the default aspect ratio is 4:3.

TO SET UP A NEW DOCUMENT USING PRESETS:

- 1 Choose File menu > New Document. The Document Setup dialog appears.
- 2 Click one of the preset aspect ratios displayed along the right side of the dialog.

These presets are aspect ratios for many useful document types. The pixel values that are placed in the Document Resolution fields are either absolute (as in Legal or Letter paper sizes) or based on your available screen resolution (as in Maximum Recommended or Square).

OPENING AN EXISTING FILE

Bryce can open any file created in any previous version of Bryce (Mac® or PC).

TO OPEN AN EXISTING FILE:

- 1 Choose File menu > Open.
- 2 Use the dialog controls to locate and open your file.

MERGING SCENES

You can merge two Bryce scenes using the Merge command. When you use this command, the scene you are opening is merged with the currently open scene. Objects from the scene you're opening are placed in your current scene at the same absolute coordinates that they previously occupied. Some information from the scene you're opening will be discarded, such as family names.

TO MERGE TWO SCENES:

- 1 Choose File menu > Merge. A dialog appears prompting you to save the current scene.
- 2 Click Save. The Open dialog appears.
- 3 Use the dialog controls to locate the file you want to merge and click Open.

The file you selected is merged with the current scene.

Holding down the Option/Alt key while performing this function will merge only the sky from the incoming scene.

USING THE BASIC FEATURES OF BRYCE

Bryce has a large number of tools and capabilities to help you create and animate scenes. The following table lists the basic features of Bryce to help you get started.

For information on	See
Creating objects	"Creating Objects" on page63
Arranging objects	"Arranging Objects" on page201
Editing objects	"Editing Objects" on page229

Editing terrains	"Editing Terrains" on page91
Creating skies	"Creating Skies" on page241
Working with materials	"Applying Materials" on page127
Working with textures	"Creating and Editing Textures" on page169
Working with the camera	"Using the Camera" on page287
Working with the lights	"Creating and Editing Lights" on page273
Rendering scenes	"Rendering" on page301
Animating scenes	"Animating" on page319

WORKING IN A SCENE

When working in Bryce, you position objects in three-dimensional space while looking at a two-dimensional display. You may find that your scenes become rather large, and you might not be able to see the entire landscape in the Working Window.

DISPLAYING YOUR SCENE

Bryce has several tools that can help you position elements and see every inch of your new world from all angles. You can also control how individual objects are displayed in the Working Window, and how your scene is displayed in the Nano-Preview.

USING THE NANO-PREVIEW

The Nano-Preview is where your object is displayed before you render it. Nano-preview can display your scene from a number of different angles without affecting the position of the camera.

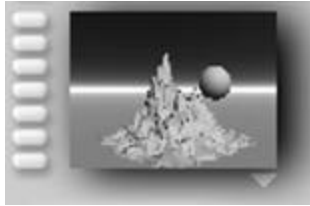

The Nano-Preview displays a rendered preview of your scene.

To display your scene from different angles in the Nano-Preview:

- Click the triangle icon below the Nano-Preview and choose a preset display angle. The view of your scene does not change in the Working window.

To set Nano-Preview options:

- Click the triangle icon below the Nano-Preview and choose a display option:
 - Sky Only previews only your sky settings.
 - Full Scene previews your actual scene. This is the default setting for the Nano-Preview.
 - Wireframe Only previews your wireframes only, as opposed to a rendered preview.
 - Auto Update will automatically update the preview render with every single change you make during your session. In most cases, this gives you almost immediate feedback after any action. On slower machines, or when working with highly complex scenes, you can deselect this option.

With this option deselected, you'll need to click in the Nano-Preview window to update the render.

- Select either Fast Preview or Full Rendering to adjust the quality of the rendered preview. With Full Render selected, every pixel is raytraced and anti-aliased. Fast preview mode skips pixels to

achieve faster updates. This can cause small objects to be partially or completely missing.

Using the View Control

Bryce lets you view your scene from several preset positions: Main, Top, Front, Side, Bottom, Right, Left, and Back. All these views, with the exception of the Main View, are special Orthogonal projections which allow perspective-free views well-suited for alignment operations. Refer to "Orthogonality and Views" on page 21 for an explanation of how and why Bryce uses Orthogonal projections.

The View control is an interactive way of cycling through the various preset views. The current position of the View control indicates the view you're seeing in the Working window.

To switch views using the View Control:

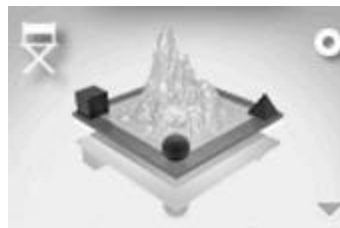

- Click or drag the Views control until you reach the view you are looking for. Every time you click the control Bryce displays a different preset view.

To switch views using the View Control Menu:

- Click the triangle icon next to the View control and select a view option:
 - Director's View: select this option to view your scene from the perspective of a director sitting outside the scene.

- **Camera View:** select this option to view your scene as the Camera sees it, based on the Camera's current location and orientation.
- **From Top:** select this option to view a perspective-free orthogonal projection of your scene as seen from above (based on absolute world coordinates).
- **From Right:** select this option to view a perspective-free orthogonal projection of your scene as seen from the right (based on absolute world coordinates).
- **From Front:** select this option to view a perspective-free orthogonal projection of your scene as seen from the front (based on absolute world coordinates).
- **From Left:** select this option to view a perspective-free orthogonal projection of your scene as seen from the left (based on absolute world coordinates).
- **From Back:** select this option to view a perspective-free orthogonal projection of your scene as seen from behind (based on absolute world coordinates).
- **From Bottom:** select this option to view a perspective-free orthogonal projection of your scene as seen from below (based on absolute world coordinates).

To switch views using the keyboard:

- Select a preset view shortcut:
 - Director's View= ~
 - Camera View= 1
 - Top View= 2
 - Right View= 3
 - Front View= 4
 - Saved views= 5 through 9

To RESET THE VIEW OF YOUR SCENE:

- Click the triangle icon next to the View control and choose Reset Views, or

- Press the Option/Alt key and click on the Views icon.

This option resets your View to the default setting.

ORTHOGONALITY AND VIEWS

When you view a scene from the side, front, top, or bottom using the Camera, you'll see certain amounts of perspective distortions. These distortions can make precise visual alignments difficult.

For instance, if you have a dozen cubes in different locations and you place the camera so that it looks down on the scene from above, you will find it very difficult to place the cubes on top of one another. Cubes further from the camera would be slightly smaller than cubes close to the camera, resulting in a confusing array of lines. The more complex the scene, the more confusing and difficult this kind of alignment becomes.

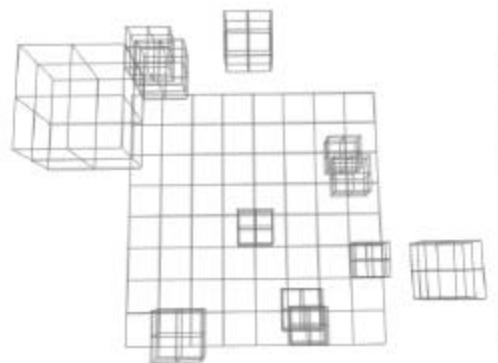

If you viewed objects from above through a real-world camera, the perspective distortions would make alignment or placement difficult.

To solve this problem, Bryce uses a perspective-free, *drafting board* kind of view in which like-sized objects far away appear exactly the same as those up close.

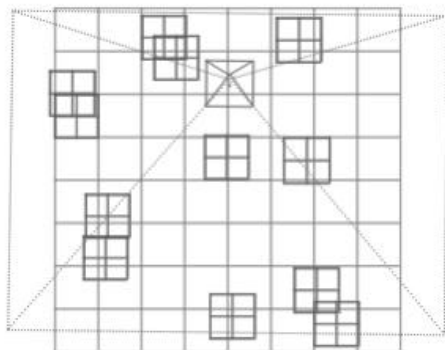

Bryce uses an “orthogonal projection” of your objects to eliminate perspective distortion.

This perspective-free view is called an *orthogonal projection*. In Bryce, all views other than your Main View (that is, Top, Bottom, Right, Left, Front, and Back) are orthogonal projections. They are not generated by the camera, and so do not contain the perspective distortion that would necessarily come with a camera view.

As a result, Camera controls do not work in these views. You can navigate within the orthogonal views using the Zoom and Pan tools.

If you press the Render button while in an orthogonal view, Bryce will quickly set up the camera position you need and render your image. There may be slight differences between what you see in the wireframe projection and what you see in the rendered image, as a result of the added perspective distortion in the rendered image.

Zooming In and Out

In Bryce, there is a difference between moving the camera and using the zoom tools.

When you move the Camera, you’re moving in 3D space. When you use the pan and zoom controls, you’re transforming a 2D projection of your 3D scene—your camera position does not change.

When you use the Zoom tool, you are essentially making the 2D projection larger or smaller. Your camera position in 3D space does not change.

To zoom in:

- Click on the Zoom In tool.

Bryce scales the 2D projection of your scene larger, creating the illusion of zooming into your 3D scene; your camera position remains unchanged.

Keyboard Shortcut: plus (+)

To zoom out:

- Click the Zoom Out tool.

Bryce scales the 2D projection of your scene smaller, creating the illusion of zooming out of your 3D scene. Your camera position remains unchanged.

Keyboard Shortcut: minus (-)

To zoom into a specific area:

- Hold down Command-Spacebar/Ctrl+Spacebar and drag a marquee around an area of your scene.

Your cursor changes to a Zoom tool, and Bryce centers and scales up the area in the marquee to fit your window.

To zoom using the mouse:

- Hold down Command-Option-Spacebar/Ctrl+Alt+Spacebar and drag the mouse left or right in your scene. Dragging left zooms in and dragging right zooms out.

To zoom numerically:

- 1 Double-click the Trackball in the Control palette. The Camera & 2D Projection dialog appears.
- 2 Enter a value in the Scale field.
The default value is 100%.

You can only zoom numerically when you are working in either Director View or Camera View.

TO RESET THE ZOOM VALUE:

- Press the Option/Alt key and click the Zoom tool.
The view of your scene resets to 100%.

PANNING

Panning works the same way as zooming. When you use the Panning tool, you are moving a 2D projection of your scene right and left, up and down, in front of the camera. Your camera position in 3D space does not change.

TO PAN YOUR SCENE USING THE PAN TOOL:

- Drag over the Pan tool in the direction you want your scene to move.

TO PAN YOUR SCENE USING THE SPACEBAR:

- Hold down the Spacebar and drag your scene in the direction you want your scene to move.

TO PAN NUMERICALLY:

- 1 Double-click the Trackball in the Control palette. The Camera & 2D Projection dialog appears.
- 2 Enter a value in the Horizontal field.
The default value is 0.
- 3 Enter a value in the Vertical field.
The default value is 0.

You can only pan numerically when you are working in either Director View or Camera View.

CHANGING OBJECT DISPLAY

You can change how your objects are displayed using the Object menu commands. Changing the object preview can greatly reduce redraw time in a complex scene. The Object's preview does not affect how the object renders.

To display objects as boxes:

- 1 Choose Object menu > Show Object as Box.

This command displays any selected object, objects, or group as box(es). This is useful when you just want to work with the object's position but don't need more details.

Keyboard Shortcut: Command/Ctrl+B.

To display objects as wireframes:

- Choose Object menu > Show Object as Lattice.

Use this command to change objects shown as boxes back to wireframes.

Keyboard Shortcut: Command/Ctrl+L.

Using Fly-around View

You may have noticed a tiny circular icon above and to the right of the Views icon. If you click here, you will change from your current View to a special *motion view*, or Fly-around View. This view gives you a sense of context in your Bryce world. If you're working close to the ground, or stuck in the midst of a clump of trees, or you've lost a cube you know you created a half an hour ago, you can use the Fly-around view to see your entire scene all at once.

In Fly-around view, Bryce positions the Camera on an imaginary monorail track above and away from your scene so that you can see the whole scene from all sides as the camera moves around it.

To switch to Fly-around view:

- Click the Fly-around view icon next to the View control. The View control changes to the Fly-around control.

To switch back to Camera view:

- Click on the View control icon next to the Fly-around control.

To change the angle of your scene in Fly-around view:

- Drag your mouse in your scene. The scene rotates in the direction you drag.

To zoom in and out in Fly-around view:

- Hold down the Command/Ctrl key and drag up or down. Dragging up zooms in and dragging down zooms out.

To slow the Fly-around:

- Hold down the Shift key.

To pause the Fly-around:

- Press the Spacebar. Press the Spacebar again to resume the Fly-around.

To end the Fly-around and save the Fly-around position:

- Press Return/Enter. The view switches back to Camera view and the last Fly-around position becomes the new Camera View.
Keyboard Shortcut: Command-Y/Ctrl+Y.

POSITIONING THE CAMERA

The Camera View is produced by the Camera which exists in 3D space, meaning that you can view your scene from anywhere within your Bryce environment — even underneath it. The Camera View can be positioned using the positioning tools or by repositioning the Camera in the scene. Refer to “Positioning the View of Your Scene” on page 291 for more on positioning the camera.

USING THE MOVIE PREVIEW

In addition to viewing still images in the nano-preview window, you can use the same window to see a small version of your animation, without leaving Bryce.

Refer to “Previewing Animations” on page 327 for more on using the movie preview.

UNDOING OPERATIONS

The Undo and Revert to Saved commands let you erase the effects of changes you made to your scene.

To undo the last operation:

- Choose Edit menu > Undo or press Command/Ctrl+Z.

To redo the last operation:

- Choose Edit menu > Redo or press Command/Ctrl+Z after performing an undo.

To revert to the last saved version of your scene:

- Choose File menu > Revert to Saved.
All unsaved changes are discarded.

THE MARKER PEN

The Marker Pen adds the functionality of a white board to your scene. When you’re using the Marker Pen, you can draw anywhere in the Bryce environment without affecting your scene. One key click erases all the marker pen lines.

To draw with the marker tool:

- 1 Click the Marker Pen tool or press the M key.
- 2 Drag it anywhere on your screen.

To erase marker pen lines:

- Click the Marker Pen tool again or press the M key again.

SAVING AND CLOSING

The Save command lets you save your work in a convenient location for later use. Since your scene files can quickly become large and complex, you should save your work often.

SAVING FILES

TO SAVE A FILE:

- 1 Choose File menu > Save. The Save dialog appears.
- 2 Use the dialog controls to choose a location for your work and click Save.

TO SAVE A FILE UNDER A DIFFERENT NAME:

- 1 Choose File menu > Save As. The Save dialog appears.
- 2 Enter a new name and/or location in the fields provided and click Save.
- 3 A copy of your work is saved, leaving the original intact.

If the Image With Scene Open/Save preference is selected, Bryce saves both the scene data and the rendered image when it saves the file.

CLOSING

When you close the application, a dialog appears asking you to save your work.

TO CLOSE BRYCE:

- Choose File menu > Quit or press Command/Ctrl+Q.

SETTING APPLICATION PREFERENCES

By setting application Preferences, you can customize Bryce to suit the way you work. You do not have to restart Bryce to make these changes take effect.

Application Preferences are set in the Preferences dialog.

TO SET THE APPLICATION'S LAUNCH STATE:

- 1 Choose Edit menu > Preferences. The Preferences dialog appears.

- 2 Enable either Launch to Previous State or Launch to Default State.

Launch to Previous State launches Bryce using the settings from your last session.

Launch to Default State launches Bryce using the default settings.

TO SAVE IMAGES USED IN A SCENE WITH A FILE:

- 1 Choose Edit menu > Preferences. The Preferences dialog appears.
- 2 Enable Image with Scene Open/Save.
With this option enabled, Bryce will automatically open or save a PICT or BMP file (PICT/BMP files are automatically appended with the extension), along with your scene file, every time you open or save. In most cases, this option should always be selected.

TO CONTROL NEW OBJECT PLACEMENT:

- 1 Choose Edit menu > Preferences. The Preferences dialog appears.
- 2 Enable either Create Objects Within View or Create Objects at World Center.
Create Objects Within View places newly created objects within the camera view, rather than at world center.
Create Objects at World Center places newly created objects at world center, regardless of whether they will be visible in your current camera view.

SETTING UP THE BRYCE WINDOW

When you first launch Bryce, the interface snaps to the edges of your Working window. The menu bar is hidden until you pass your cursor over it, and other applications are hidden behind Bryce. This setup lets you work with an uncluttered desktop.

To maximize the Bryce window:

- 1 Pass the cursor over the right side of the Working window. The Advanced Display palette appears.
- 2 Click the Interface Max/Min tool.
- 3 Click the tool again to switch to a standard window.

SETTING UP THE WORKING WINDOW

Before you start working in Bryce, you can change the display mode to determine how objects are displayed in the Working window. These display modes can help you when you're arranging objects and can also speed up your redraw time.

Display Modes

The Display Mode tool, at the bottom-right corner of your Working window, toggles through the three possible display modes.

To switch BETWEEN display modes:

- 1 Click on the Display Mode tool in the corner of the Working window.

This button is only visible when you pass your pointer over it.

- 2 Click the button until you're in the desired mode.

There are three modes available:

- Wireframe Display shows all objects as wireframes.

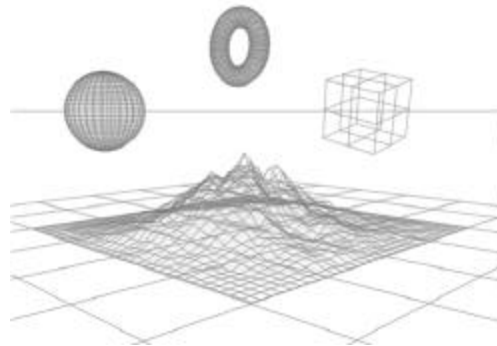

In Wireframe Display all objects are shown as wireframes.

- Bitmap Display shows a rendered scene. The display automatically switches to this mode whenever you click the Render button.

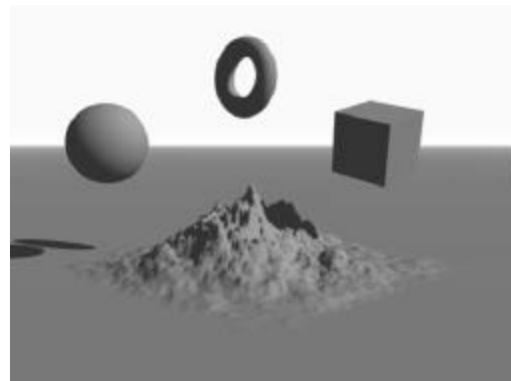

In Bitmap Display all objects are displayed as rendered objects.

- Wireframe/Bitmap Display lets you edit wireframes while simultaneously viewing the most recently rendered version of your scene behind them.

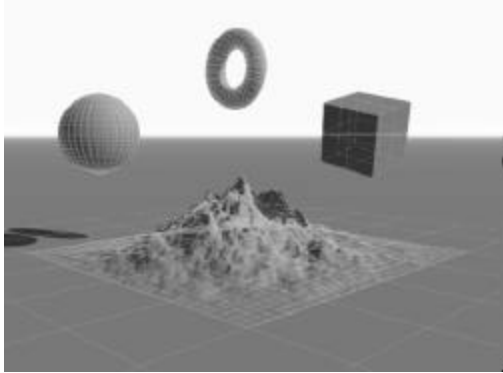

In Wireframe/Bitmap display, all objects are displayed as wireframes, but with the rendered image in the background.

This mode is most useful when you have a partially-rendered image and want to improve the results. If you switch to this mode, you can move your wireframe objects relative to the rendered image behind them in order to accurately judge the results of your change.

To toggle between modes:

- Press the Esc key.

The Esc key will toggle between the last Wireframe mode you selected (Wireframe or Wireframe/Bitmap) and Bitmap mode.

FLAT SHADED PREVIEW MODE

This preview mode is only available if your system contains hardware that supports OpenGL®, Sree3D, or Direct 3D®.

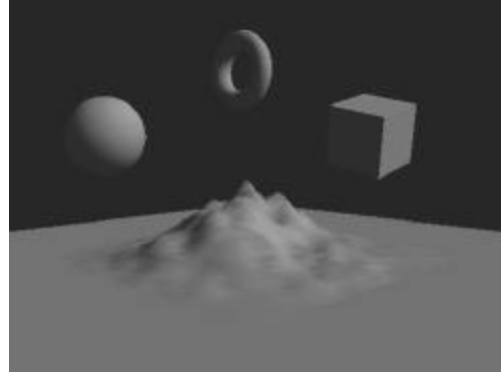

In Flat Shaded Preview display, all objects are displayed as flat shaded solids.

When this mode is active your objects appear as flat shaded solids, without materials, instead of wireframes, and you can see the effects of light sources on object surfaces.

To display objects in FLAT SHADED PREVIEW:

- Hold down the mouse button over the Display Mode button and choose SGI OpenGL, Sree3D, or Direct3D from the menu.

WIREFRAME ATTRIBUTES

When you're in Wireframe mode, there are several options you can set to make the display more helpful. Disabling some of these options may speed up drawing time.

To set WIREFRAME ATTRIBUTES:

- 1 Make sure you're in Wireframe mode. Click the Display Mode tool until the display switches to Wireframe.
- 2 Drag the Depth Cue control up or down. Drag up to increase the intensity of the depth cueing effect and drag down to decrease it.

When depth cueing is active, the wireframe appears lighter the farther it is from the camera.

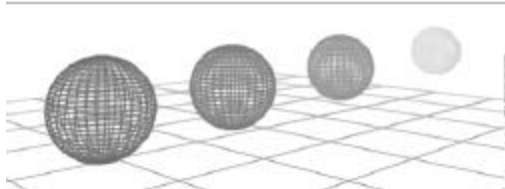

When depth cueing is active, objects appear lighter the farther they are from the camera.

If you hold down the Control key/Ctrl+Alt keys and click on the Depth Cue icon, Bryce will turn both anti-aliased wireframes and depth cueing on or off simultaneously.

- 3 Click the Wireframe Shadows button to turn shadows on or off.

Shadows are designed to help you determine object placement in your scene. For this reason, shadows appear even when there is no ground plane or when the object is below the ground plane.

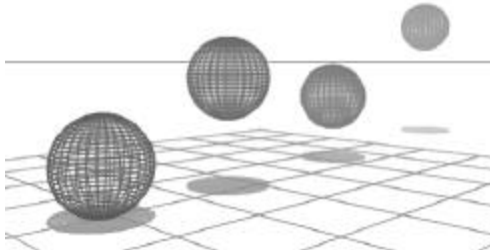

You can use wireframe shadows to help you determine the placement of objects in the scene.

This feature may slow down your system when working with a complex scene on slower machines.

- 4 Click the Underground On/Off button to hide or show underground lines.

When underground lines are hidden, any portion of a terrain or object that is positioned below ground level will not be visible in your

wireframe scene. This is useful for easy visualization and composition. However, you might overlook an object that is hidden underground.

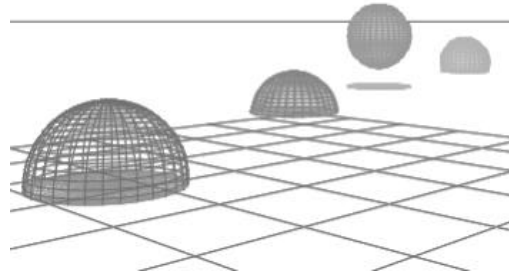

When underground is enabled, objects that are positioned below the ground plane are not visible in the scene.

- 5 Click the Resolution tool and choose Static, Selected, or Motion. Then choose a resolution for the wireframe mode.

Static lets you define the resolution of the wireframe when the object is not moving and not selected.

Selected lets you define the resolution of the wireframe when the object is selected.

Motion lets you define the resolution of the wireframe when the object is being moved.

Window Backgrounds

The background texture of the working window can add a great deal to the overall look of the interface. It makes it easier to see wireframes and selected objects.

To select a background texture:

- Click the Background Paper button and choose a background from the menu.

Adding a background texture may slow down some machines. If you need more speed for any reason,

select No Texture, and you will get a simple, clean background with no texture.

To select a background color:

- 1 Click the Background Paper button and choose Select Color from the menu.
- 2 Use the color picker to select a color.

CUSTOMIZING BRYCE

The Bryce interface can be customized to better suit your personal workflow. If you want to, you can tear apart the interface and reposition any palette, or you can choose to hide the entire interface and leave only the working window visible.

To move a palette:

- Hold down the Spacebar and drag the desired palette to a new location.

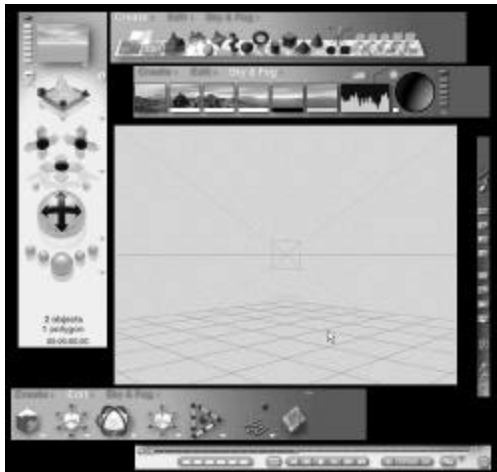

When you break the interface apart, you can see all the palettes at the same time. You can move these palettes anywhere in the Bryce window.

To reset a palette to its original position:

- Hold down the Option/Alt key and the Spacebar, then either click on a palette or

choose Edit menu> Reset Palettes to reset all palettes to their default positions.

To hide the BRYCE INTERFACE:

- 1 Press Command/Ctrl+Alt. All the palettes disappear and your image appears at the center of your work space.
- 2 Press Command/Ctrl+Alt again to display all the palettes.

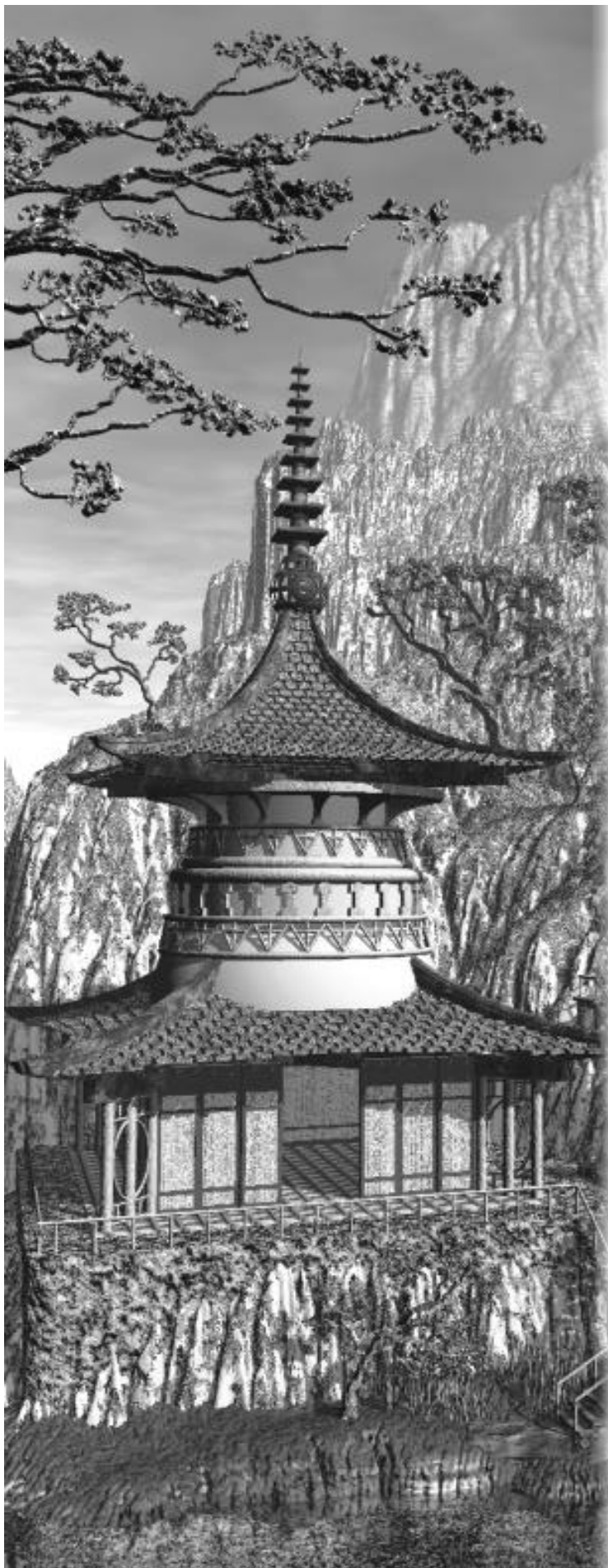

3

TUTORIAL

Welcome to the Bryce tutorial. This tutorial introduces you to the major features and functions of Bryce. The main goal is to teach you the basic techniques you'll need to create landscapes and environments.

There are two separate tutorials. The basic tutorial shows you how to create a terrain, customize the sky, and create a body of water. "Creating a vaulted roof" on page 40 teaches you how to create a more complex environment and how to create an animation.

Each section of the tutorials is self-contained, so you can start from any point. All the files necessary for completing the lessons are provided for you on the Bryce CD-ROM in the folder "Manual Tutorial."

GETTING STARTED

LESSON 1: CREATING A DOCUMENT

When you set up a new document, you define the size of your working space in pixels. The higher the resolution, the larger your working space. The resolution you choose depends on what type of scene you want to create.

To help you choose a resolution, Bryce provides several preset aspect ratios for the most commonly used types of documents. Refer to “Setting Up the Working Window” on page 26 for a complete discussion of resolutions and aspect ratios.

To set up a new document:

- 1 Choose File menu > New Document.
The Document Setup dialog appears.
- 2 Click the button beside the Default preset in the list of presets on the right side of the dialog.
The Resolution and Aspect Ratio fields update automatically.
- 3 Click the OK icon at the bottom of the dialog to accept your changes and exit the dialog.

Now that you have a document, you can set up the camera view and start creating a scene.

LESSON 2: POSITIONING THE CAMERA

In this lesson you'll use the Director's View to view objects. In this view, you can see all the objects in the scene including the camera.

There are four controls you can use to position the camera: the Camera axes controls, the Trackball, the Preset Views and the Camera and 2D Project dialog. Most of these tools are located on the Control Palette.

Refer to “Positioning the View of Your Scene” on page 291 for more on these tools.

When you reposition the camera, you're changing the view of the scene, not the position of the objects.

To open the camera lesson file:

- 1 Choose File menu > Open.
- 2 On the CD-ROM, locate the file Manual Tutorial: Camerascene, and click Open.

To reposition the camera using the camera axes controls:

- 1 On the XZ control, drag the Z arrow up to move the scene away from you.



When you move over the tip of an arrow in the Camera control, the cursor changes to an axis indicator.

- 2 On the XY control, drag the tip of the Y arrow up to move the scene up.

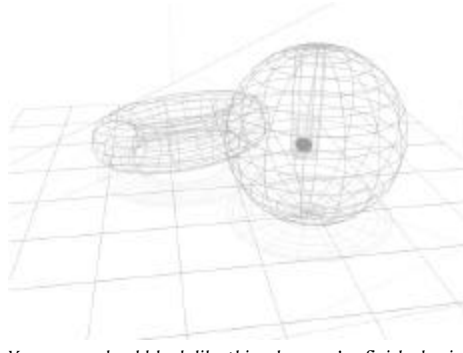

Your scene should look like this when you've finished using the Camera controls.

The sphere and the torus objects should now be easier to see, but you can adjust the camera again to get a better view of the hidden cylindrical objects.

To reposition the camera using the Trackball:

- 1 Click the center of the Trackball and drag to the right. The scene appears to rotate to the left.



Use the Trackball to rotate the camera around the scene.

The camera is now in an almost perfect position to view the scene. You can place the camera in a precise position by moving it numerically.

To reposition the camera numerically:

- 1 Double-click the Trackball. The Camera & 2D Projection dialog appears.
- 2 Enter Position X=104, Position Y=32, Position Z=-100, Rotate X=0, Rotate Y=-46, Rotate Z=0
- 3 Leave the remaining values at their defaults.
- 4 Click the OK icon to apply the changes to the camera.

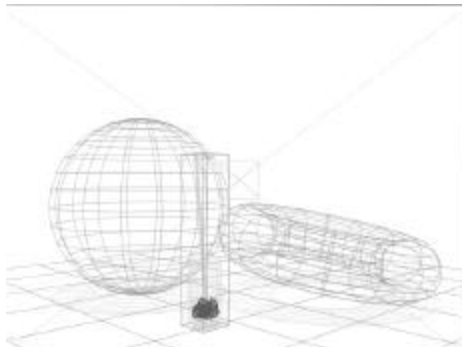

When you apply the values you entered in the Camera & 2D Projection dialog, the view of your scene should look like this.

- 5 Close the file. You don't need to save the file unless you want to.

ARRANGING OBJECTS IN THE SCENE

A 3D illustration depends heavily on the arrangement of the objects in the scene to create a specific look or feel.

In 3D space, an object can be viewed from any angle. You should take all of these angles into account when you're arranging objects.

The lessons in this section will help you learn how to add, position and transform objects to create a 3D illustration.

LESSON 3: Adding and Adjusting the Terrain

To create a terrain:

- 1 Click Create to display the Create Palette.
- 2 Click the Terrain Object.

The terrain appears in your scene.

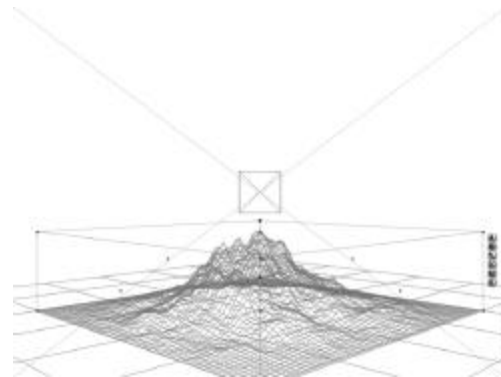

Terrain 1

To reposition the terrain:

You can use the Reposition tool to move the terrain to the rear left of your scene.

As you move the mouse pointer over the arms of the Reposition tool a small tag appears and

displays the name of the axis over which you are positioned.

- 1 With the terrain selected (outlined in red), click Edit to display the Edit Palette.
- 2 Click the upper X (left) arm of the Reposition tool, and drag to the left. The terrain will move along the X axis towards the rear of your scene.
- 3 Click the upper Z (right) arm of the tool, and drag to the right. The terrain will move along the Z axis towards the middle of your scene.
- 4 Repeat this process as needed until the terrain is in the position shown below.

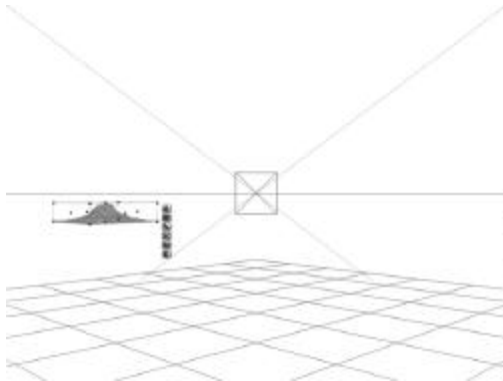

Repositioning a terrain

TO RESIZE THE TERRAIN:

- 1 With the terrain still selected, click the center of the Resize tool, then drag to the right to increase the size of the terrain.

Notice that as you resize the terrain it appears to disappear below the ground plane. The ground plane is the grid in the foreground which appears by default whenever you start a new project. It is an infinite plane because it extends to infinity along the X and Z axes. The terrain appears to disappear because it is resized evenly about its center.

- 2 Click the Land Objects button (the arrow button located at the bottom of the vertical row of buttons to the right of the terrain).

The terrain repositions on the ground plane and the arrow button disappears.

- 3 Resize the terrain until it looks something like the image below.

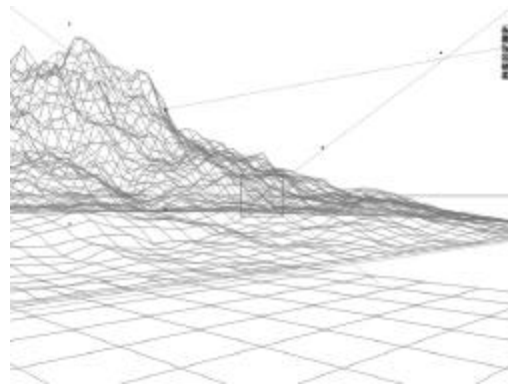

The terrain so far

TO ADD AND REPOSITION A SECOND TERRAIN:

- 1 Click Create, then click the Terrain Object to add a second terrain.
- 2 Click Edit, to display the Edit palette.
- 3 Use the Reposition tool to move the terrain to the far right of the scene.
- 4 Increase the size of the terrain, using the Resize tool.

Note that this terrain (Terrain 2) is further back than the first one.

- 5 Click the Land Objects button to align the second terrain along the ground plane.

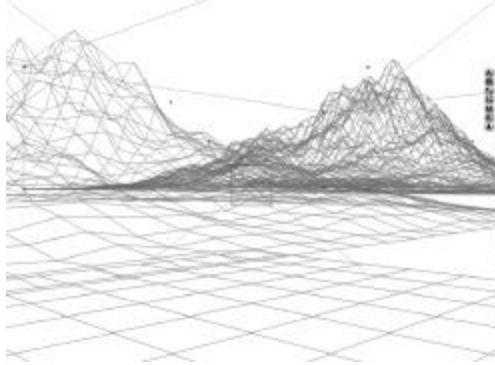

A second terrain

- 6 Click the Render button to view your image.

To switch back to WIREFRAME display mode:

- Click the Display Modes button once to return to Wireframe display mode, or hit the Escape key to toggle between the modes.

To CHANGE THE TERRAIN'S APPEARANCE:

- 1 Select Terrain 2. The wireframe turns red.
- 2 Click the Editor button (the E button located in the vertical list of buttons associated with the selected terrain object). Your screen is overlaid by the Terrain Editor.
- 3 In the Editing Tools palette, click the Eroded button twice.
- 4 Exit the Terrain Editor by clicking the OK icon.
- 5 Select Terrain 1.
- 6 Click the Editor button to display the Terrain Editor.
- 7 In the Editing tools palette, click the Smoothing button once.
- 8 Exit the Terrain Editor by clicking the OK icon.

LESSON 4: Applying TEXTURES

Now you will apply a material to the terrains and the ground plane.

To apply A TEXTURE:

- 1 Click the Display Modes button to return to Wireframe display mode.
- 2 Select Terrain 1.
- 3 Hold down the Shift key on your keyboard and click Terrain 2; still holding the Shift key down, click the ground plane (Plane 1).
All three wireframes are selected and outlined in red.
- 4 Click the triangle icon next to Edit, to display the Material Presets selection panel.
- 5 In the Material Presets selection panel, click Planes and Terrains. Another selection of preset materials appears.
- 6 Click Desert Rock. (sixth from the left and the third from the top)
A red border appears around your selected material.
- 7 Click the OK icon to return to your scene.
If you look at the Nano Preview window (top left), you'll see that the Desert Rock material has been applied.
- 8 Click the Render button.

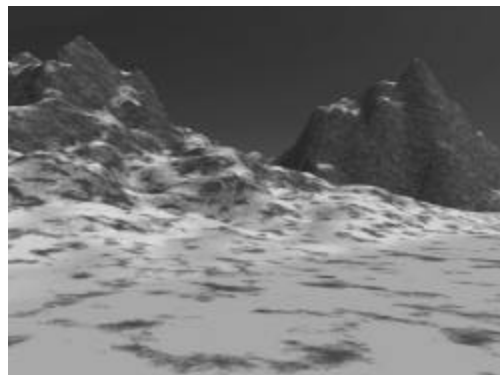

The terrains after texture has been applied.

CREATING THE Sky

To complete these lessons, you'll need a terrain. If you've been following this tutorial from the beginning, you can use your scene. Otherwise, you can use the sample file provided for you. The sample file is called Finished Terrain and is located on the CD-ROM in the Manual Tutorials folder.

LESSON 5: Adding a Sky PRESET

You can add a sky preset to the scene.

To add a sky preset:

- 1 Click the triangle next to Sky & Fog.
A selection of sky presets appears.
- 2 Click Jet Stream.
- 3 Click the OK icon to add the sky preset.

LESSON 6: Adjusting the Sky

Once you have added a sky preset you can adjust the appearance of the sky. You can determine what type of clouds are included in the scene. You can also add perspective to the scene by adjusting the amount of Haze in the scene.

To modify the clouds:

- 1 On the Sky & Fog palette, click the triangle beneath the Sky Memory Dots. This displays the Sky & Fog options menu.
- 2 From the menu that appears, click Cumulus Clouds to deselect it.

To adjust the sky:

- 1 Move the pointer over the thumbnails on the Sky & Fog palette to locate the Haze thumbnail.
Note that the names of the palettes appear in the bottom left of the Bryce window.
- 2 Click the Haze thumbnail.

The number 1 appears at the bottom left corner of the Bryce window; this is the Haze value.

- 3 Click the Haze thumbnail, drag to the right to increase the Haze value to 17.
- 4 Render your scene again.

Note that the increased haze value has separated the two mountains, appearing to push the second terrain farther back in the distance.

CREATING A Body of WATER

To complete these lessons you'll need a terrain. If you've been following the tutorial from the beginning, you can use the files you have created. Otherwise, you can load the sample file, Finished Sky provided for you on the CD-ROM.

LESSON 7: PREPARING THE LANDSCAPE

Next you will create a body of water by digging a hole and adding some water.

In this tutorial, we'll use a Negative Boolean operation to cut a hole out of the ground plane. A Negative Boolean operation requires a Positive object (or a Positive group of objects) and a Negative object. When these are grouped together the shape of the Negative object is cut out of the Positive object. Objects can be given Negative, Positive, Neutral or Intersect attributes in the Object Attributes box.

To set the landscape as a Positive Boolean object:

- 1 Click the Display modes button to switch to Wireframe mode.
- 2 Select one of the terrains.
- 3 Holding down Shift, select the second terrain and the ground plane.

All three wireframes should now be highlighted in red.

- 4 Click the Object Attributes button (the A button), then enable the Positive option. This makes each one of the selected objects positive.
- 5 Click the OK icon.

To group the terrains:

- 1 Click the Group button (the G button in the vertical list associated with the selected objects).
This will group the three objects (Terrain 1, Terrain 2, and Plane 1) together in a Group called Group 1.
- 2 With Group 1 still selected, click the Objects Attributes button.
- 3 Enable the Positive option.
- 4 Click the OK icon.

LESSON 8: CREATING THE INTERIOR OF THE LAKE

Next you will create a third terrain object—Terrain 3 -and apply the same Desert Rock material as you used before. Then you will rotate the terrain object to create an inverted terrain that will eventually form the interior of the lake. Next you will make the inverted terrain a Negative Boolean object. Grouped with the positive terrains created in the last lesson, this negative terrain will 'cut' a hole out of the ground plane.

To create a new terrain object:

- 1 Click Create.
- 2 From the Create palette, click the terrain object to add a third terrain.
- 3 Click Edit.
- 4 Click the triangle icon next to Edit to display the Material presets selection panel.
- 5 Click Planes & Terrains.
- 6 Click Desert Rock.
- 7 Click the OK icon.

This terrain needs to be rotated through 180 degrees about the X or Z axis to create the interior of the lake.

To rotate an object:

- 1 Click Edit.
- 2 Locate the Rotation tool. Move the pointer over the X or Z axis rotation ring.
- 3 Hold down the Shift key (this causes the rotation to be carried out in 45-degree increments), then click and drag horizontally on the rotation ring.
You'll see the angle of rotation displayed at the bottom left of your screen.
- 4 Drag until you see either 180 or -180. The terrain will now be upside down and your screen should look like this:

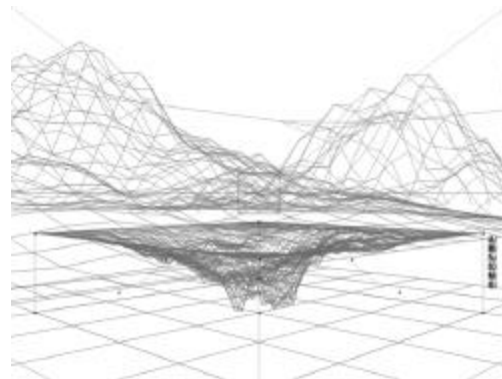

An inverted terrain.

To create a Negative Boolean object:

- 1 With Terrain 3 still selected, click on the Object Attributes button to display the Object Attributes box, then click Negative.
It is now a negative Boolean object. This means that Bryce will 'cut' this shape from the ground plane.
- 2 Exit by clicking the OK icon.

You'll notice that the Terrain 3 wireframe is dotted, since it is now Negative.

To CREATE THE LAKE:

- 1 Ensure that the Wireframe underground button, found on the Advanced Display Palette, is off.
- 2 Click and drag Terrain 3 until the square base (which is now on top) is just above the ground plane.

Watch the Nano Preview window to track your progress.

Your scene in wireframe mode should look like this:

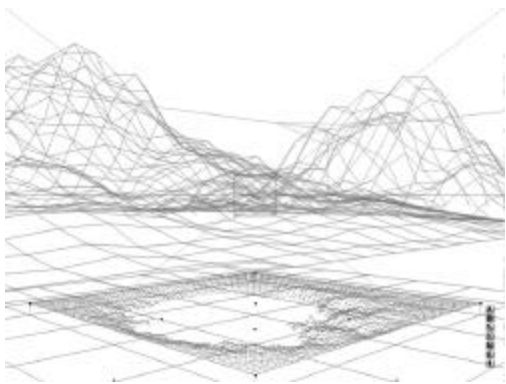

Positioning the inverted terrain

To GROUP THE TERRAINS:

- 1 With Terrain 3 still selected, hold down the Shift key and click one of the other terrains to select Group 1 together with Terrain 3.
- 2 Click the Group button.
- 3 Click the Render button to see the hole in the ground plane.



A hole in the ground plane

To MAKE THE INTERIOR OF THE LAKE BIGGER:

- 1 Click the Display modes button to return to Wireframe mode.
- 2 Click the Time/Selection toggle, located in the bottom right corner of the Bryce window, to display the selection palette.
- 3 Click and hold the Terrain icon on the Selection Palette at the bottom of the screen.
- 4 From the list, select Terrain 3.

Terrain 3 should now be the only selected object. Although it is part of a group this terrain can still be repositioned, resized and rotated on its own.

- 5 With Terrain 3 selected, use the Resize tool to make it bigger and the Reposition tool to fine-tune the positioning.

Watch the Nano Preview window to check the effect you're creating. When you lower the terrain, keep the terrain's square bottom above the ground plane; otherwise, the hole will disappear.



An enlarged hole in the ground plane.

LESSON 9: FILLING THE LAKE

Now we'll fill the hole with water.

To fill the lake:

- 1 Click Create to display the Create Palette.
- 2 Click the Water Plane icon.
A water plane appears with a random material applied. It covers the whole of your image up to the bases of the mountains.
- 3 Click the triangle icon next to the word Edit to display the Materials Presets selection panel.
- 4 Click Waters & Liquids from the list of categories.
- 5 Select Waves of Reflection (third row down, third from left).
- 6 Click the OK icon to exit the Materials selection panel.
- 7 From the View Options menu choose From Front.
- 8 Click the Wireframe underground button to display underground lines.
- 9 Click the water plane icon on the Selection Palette at the bottom of the screen.
- 10 Click Edit.

- 11 Using the Reposition tool, move the water plane along the Y axis until it is just below the ground plane.

Your scene in wireframe mode should look like this:

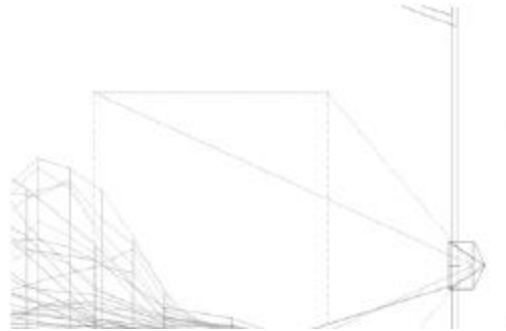

The waterplane below the ground plane

- 12 Choose Director's view from the View Options menu.
- 13 Check the Nano Preview window to ensure that the water plane has filled the inverted terrain.
- 14 Click the Render button to view the final image.

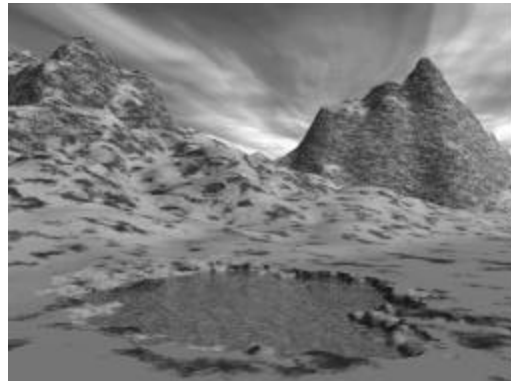

A filled lake.

This concludes the beginner's tutorial.

This tutorial has only touched on a very small fraction of the controls and procedures available in Bryce. You could go further with this image by adding some rocks and vegetation to the foreground.

Try different water materials for the lake and different terrain and plane textures and a different sky—in Bryce the variations are literally endless.

CREATING A VAULTED ROOF

In this tutorial, you will create an animation of an interior scene of a building with a vaulted ceiling. You'll work with an imported image, adjust the lighting of the scene and finally animate the camera to fly through the scene.

LESSON 10: CREATING A PYRAMID

While creating the building's roof, you will become familiar with the create and edit controls of Bryce, as well as Boolean operations.

TO CREATE THE PYRAMID:

- 1 Click Create to display the Create Palette.
- 2 Click the Create Pyramid icon.
A pyramid appears in your scene.

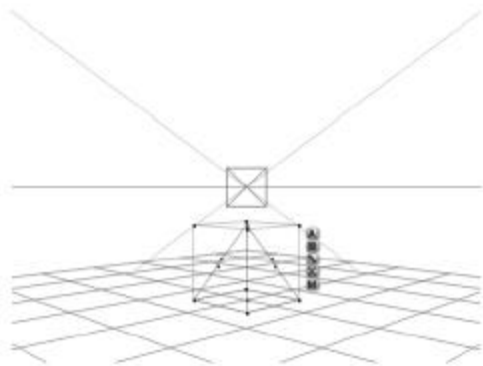

A pyramid displays

Next, make the pyramid flatter by reducing its height.

TO RESIZE AND REPOSITION THE PYRAMID:

- 1 Click Edit to display the Edit Palette.
- 2 Click the upper Y axis of the Resize tool.
- 3 Holding down the Shift key, slowly drag to the left.

Pressing the Shift key constrains the change to regular increments.

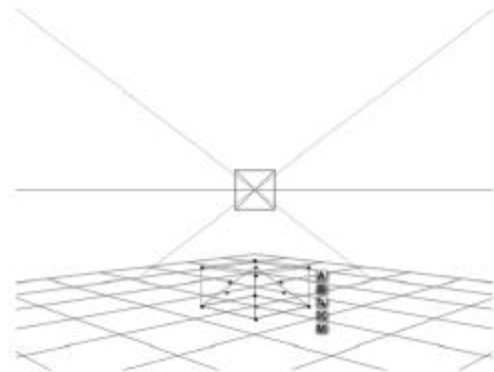

The pyramid after the height change

Next, you'll proportionately enlarge the pyramid. This time, work directly with the object's handles in the scene window.

- 4 Place the cursor over the upper right corner of the object's bounding box, next to the Object Attributes button (the A button).

The cursor changes to a proportional resize icon.

- 5 Holding down the Shift key, drag the corner of the bounding box to the right.

The pyramid snaps to a larger size.

- 6 Drag for three more snaps.

The pyramid is enlarged, and should extend off the right edge of the scene window.

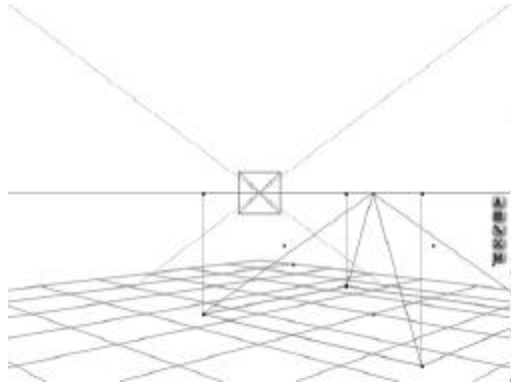

The enlarged pyramid

Next, you'll use the arrow keys to nudge the pyramid to a more central position in the scene.

- 7 Press the left arrow key four times.
The pyramid moves so that the entire object can be seen in the scene window.

LESSON 11: CONVERTING THE PYRAMID

The next task is to duplicate the pyramid and convert it to a sphere. Eventually the sphere will be "cut out" from the pyramid using a Boolean operation.

To duplicate the pyramid:

- 1 Click Edit menu.
- 2 Choose Duplicate.
A second pyramid appears in the exact place where the first one is.
- 3 Click the double arrows at the top right of the Edit Palette.
A set of Bryce primitives appears.
- 4 Drag to the left until the sphere primitive is highlighted.
- 5 Release the mouse button.
The pyramid has changed to a sphere.

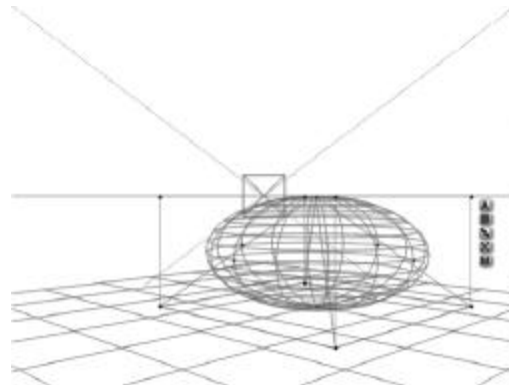

The converted pyramid

LESSON 12: RESIZE THE SPHERE

To cut the sphere out of the pyramid, the sphere needs to be resized and slightly repositioned. This time you will resize the object using Bryce the 3D Transformation dialog box.

To resize the sphere:

- 1 On the Edit Palette, click the triangle beneath the Resize tool.
- 2 Select 3D Transformations from the list.
A dialog box appears.
The bottom row of options are for changing an object's size. Size is expressed as a percentage of the current size. To enlarge the sphere horizontally without affecting the height, you will enter new values for the X (width) and Z (depth) axes and leave the height (Y) axis unchanged.
- 3 In the numerical boxes for the size of the X and Z axes, enter 125 (for 125%).
- 4 Click the OK icon to exit the dialog box.
The sphere expands slightly on the horizontal axis while the height remains unchanged.

To adjust the position of the sphere:

- 1 From the View Controls menu, select From Front.

The scene changes so that you are viewing the objects from a straight horizontal view.

- 2 Click the upper Y axis of the Reposition tool.

- 3 Holding down the Shift key, drag to the left.

The sphere drops so that it is half hidden under ground.

- 4 Release the mouse button.

Next you will lower the sphere a bit more until the next "rung" of the wireframe is aligned with the ground level.

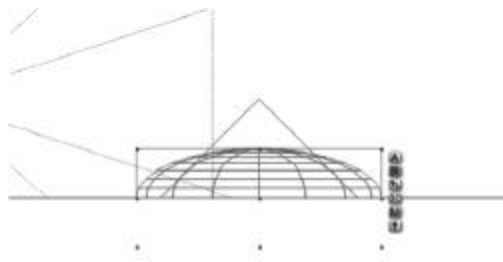

Lowering the sphere

- 5 Again, click and hold the upper Y axis of the Reposition tool.
- 6 Holding down the Shift key, drag to the left slightly until the wireframe is aligned with the ground.

You may have to repeat this step several times to get the alignment exact.

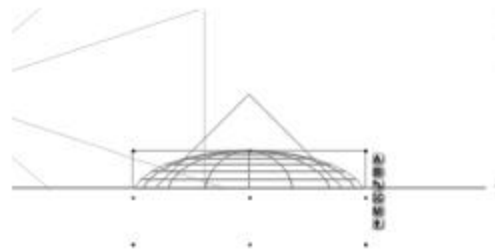

The repositioned sphere

LESSON 13: USE THE SPHERE TO CARVE OUT THE ROOF

Next you will carve out the under side of the roof with the sphere using a Boolean operation.

To CARVE OUT THE ROOF:

- 1 Change back to Director's View, by choosing Director's View from the View Options menu on the Control Palette.

Now, you will assign Boolean properties to your objects. The sphere is selected, so we'll start with that.

- 2 Click the Object Attributes button next to the sphere's bounding box.

The Object Attributes dialog box appears.

Under the title, Sphere 1, the button for Neutral is selected. That is the default for all Bryce objects.

- 3 Enable the Negative option.

- 4 Click the OK icon to exit the Object Attributes dialog box.

The sphere's wireframe changes to dotted lines.

Next, make the pyramid positive.

- 5 Select the Pyramid by clicking it. Its wireframe turns red.

You could use the Object Attributes dialog box to make the pyramid positive. However, Bryce has an easier way.

- 6 Type P (for positive).

The wireframe doesn't change; its line is still solid.

Tip To make an object negative, type N.
To make it intersect, type I. To make it neutral, type the letter O.

LESSON 14: CREATING A GROUP

To make the Boolean effect work, you must group the objects together.

To group objects:

- 1 Ensure that the Selection Palette is displayed, type S.
- 2 On the Selection Palette, click the Select Pyramid icon.
- 3 Holding down the Shift key, click the Select Sphere icon from the Selection Palette.
- 4 Click the Group button to group the selected objects.

The bounding box changes slightly, with diagonal insets at each corner. This indicates that the object is a Boolean group. In addition, the G button disappears, and a U button takes its place. (The U stands for Ungroup)

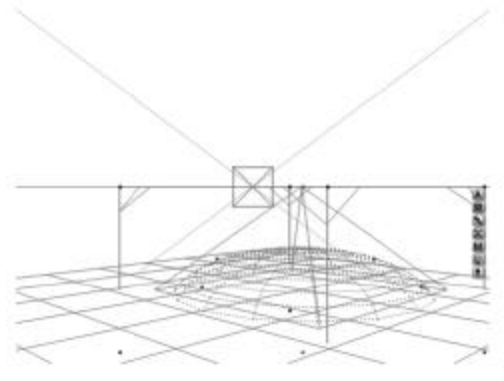

Grouping objects

- 5 Click the Render button to check your work.
Your scene should look like the following figure.

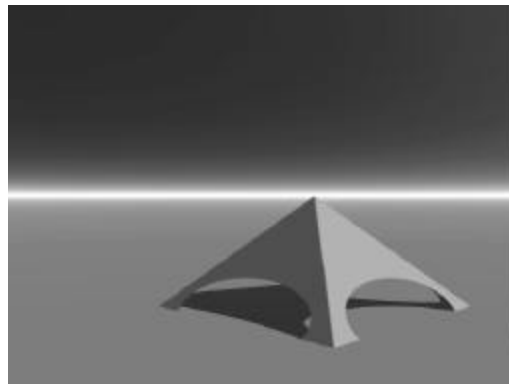

The results so far

To create a family group:

- 1 Press the Esc key to switch back to wireframe mode.
The wireframe of your scene appears.
- 2 Click the gray Family button underneath the Object Attributes button.

The Family dialog box appears. The gray color is selected and the Default Family name displays at the bottom of the dialog box.

- 3 Click the bottom left color (maroon).
The text display now reads Family 21.
- 4 Type the words Boolean Roof.
- 5 Click the OK icon to exit the Family dialog box.
The dialog box disappears, and the Family button has changed to the maroon color.
- 6 Deselect the object by clicking the background of the image.
The wireframe has now changed to maroon.
- 7 Save your scene file and give it the name Rendered Boolean.

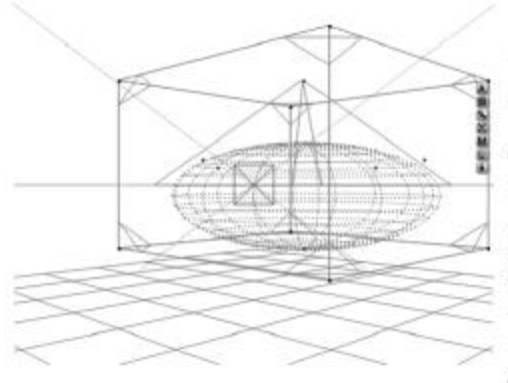

Moving the roof

Note

You can also change the position of the roof by clicking the Object Attributes button. Change the Y axis position to 35.60.

Building THE Walls

In this next section, you will create walls for your roof using the cube primitive. Before doing so, however, you will need to raise the roof so that the walls can fit underneath.

LESSON 15: MOVING THE ROOF

TO RAISE THE ROOF:

- 1 If needed, select the Group by clicking it in the scene window.
The wireframe turns red.
- 2 Press the Page Up key 6 times.
The bottom of the pyramid is aligned to the horizon.

LESSON 16: CREATING THE WALLS

You are now ready to create walls to go underneath your roof with the arched cutouts. The Cube primitive will be the basis of your walls.

TO CREATE THE WALLS:

- 1 On the Create Palette, click the Create Cube icon.
A cube appears in your scene.
- 2 Click the family color button to access the Family dialog box.
- 3 Change its color to an unused color and type the word Wall in the text entry field.
The family color is changed.

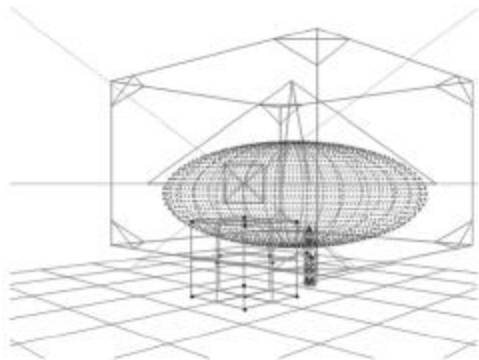

Creating the walls

- 4 Look at your scene from Top View by choosing the Control Palette, View Options menu > From Top.

The scene changes to top view.

Tip Another way to change to top view is to use a keyboard shortcut. Press the number 2 key. (or ~ for Director's View, 1 for Camera View, 2 for Top View, 3 for From Right, and 4 for From Front).

You can zoom in for a closer view.

- 5 Click the Zoom In tool on the Advanced Display palette (the Zoom In tool is the magnifying glass with a +).
The objects appear larger, with the selected cube in the center of your scene.

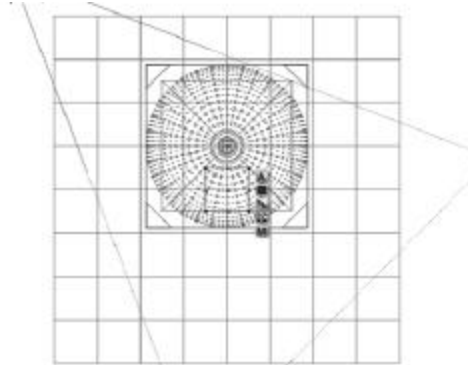

View from the top

LESSON 17: ADJUSTING THE WALL SIZE

Notice that the cube's lower edge is aligned with the pyramid's edge. However, it needs to be made wider to match the pyramid's width, but less deep so that it does not occupy so much of the pyramid's interior.

To adjust the wall size:

- 1 Place the cursor over the top center point of the cube's bounding box.
The cursor changes to a Z, indicating that Bryce is ready to work with the object along the Z axis.
- 2 Click, and holding down the Shift key, slowly drag to the left.
The cube snaps to half its depth.
- 3 Release the mouse button.
- 4 Repeat the procedure to shrink the cube to half its depth again.

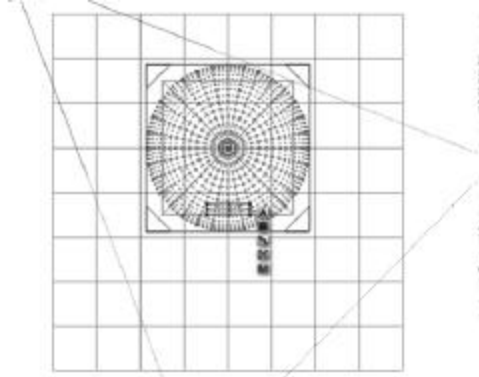

Adjusting the wall size

- 5 Place the cursor over the right center point of the bounding box.
The cursor changes to an X.
- 6 Press the Option or Alt key (this will resize the object from the center).
- 7 Click, then slowly drag to the right.
- 8 If needed, drag its points so that it aligns correctly.

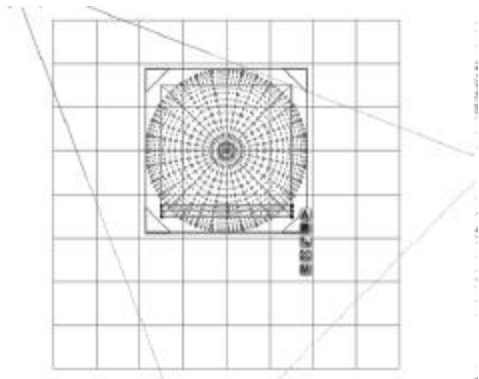

Widening the wall.

LESSON 18: DUPLICATE THE WALLS

You now have one wall. Duplicate this wall to create the one opposite.

To duplicate the walls:

- 1 From the Edit menu, choose Duplicate.
An identical cube appears in the same place.
- 2 Press the up arrow key to align the wall with the opposite side of the pyramid.
- 3 Click the Select Families icon on the Selection palette, and select Wall from the list. Both walls are selected.
- 4 Duplicate these walls by choosing Edit menu > Duplicate or by pressing Command/Ctrl+D. A second set of walls is created in your scene.

For the next action you will temporarily group the newly created second set of walls.

- 5 Click the Group button to group the walls.
The G button changes to a U, indicating that the objects are grouped. The Family button color is gray for Default family. (as a new entity, it takes on the Default family color and label)

Now you can rotate this group around its center, which happens to be the same as the center of the pyramid.

- 6 Click Edit button to display the Edit Palette.
- 7 Place your cursor over the horizontal band of the Rotate tool.
The cursor changes to a Y.
- 8 Press the Shift key to constrain rotation to 45 degree increments.
- 9 Click and slowly drag in either direction.
The group snaps first to 45 degrees, and, as you continue dragging, to 90 degrees.
- 10 Release the mouse button.
- 11 Click the Ungroup button.
The U changes to a G, and the Family color changes to the Wall color.

LESSON 19: MAKE THE WALLS TALLER

Before starting this lesson, press ~ to switch back to Director's View. This view will show more depth perspective.

To make the walls taller:

- 1 Make sure the walls are selected, then place the cursor over the top axis of the Resize tool. The cursor changes to a Y.
- 2 Pressing the Shift key, click and drag to the right until the walls pop up to meet the bottom of the pyramid.

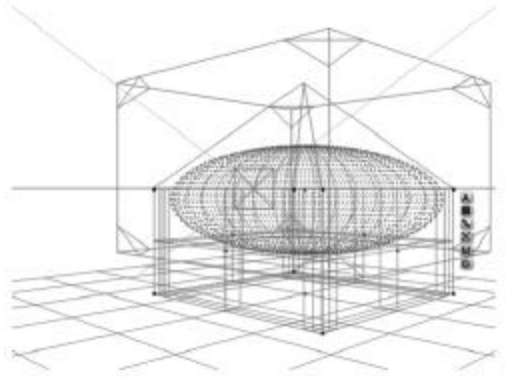

Raising the walls

LESSON 20: Adding a Doorway

You will make a doorway by duplicating and resizing one of the cubes so that it cuts a Boolean hole through the wall.

To add a door:

- 1 Switch to Top View.
- 2 Select the wall objects.
- 3 On the Selection palette, click the Solo Mode button.
All unselected objects (the ground plane and the boolean group) disappear, leaving only your selected objects and the camera.

- 4 Deselect the wall objects by clicking elsewhere in your scene window.
- 5 Click the bottom wall object to select it.
- 6 Duplicate the object by choosing Edit menu > Duplicate, or Command/Ctrl+D.

This new object will become the doorway object.

The doorway object must be a little thicker than the wall. While you're still in Top View, you will increase its depth slightly.

- 7 Click the Z axis on the Resize tool.
- 8 Hold down the Option (Macintosh) or Alt (Windows) key to change the size symmetrically.
- 9 Drag slightly to the right to make the doorway object thicker.

The other resize adjustment must be made looking at the object from Front View.

- 10 Switch to Front View.
- 11 Click the X axis on the Resize tool.
- 12 Hold down the Option/Alt key and drag to the left until the object is about the width in the following figure.

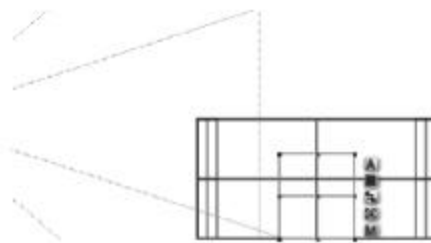

Creating the door.

- 13 Click and drag the top Y axis on the Resize tool to the left.

This will shorten the doorway. Continue until it is about the height in the previous figure.

LESSON 21: ASSIGNING BOOLEAN PROPERTIES

After the doorway object is created and sized correctly, assign Boolean properties to it. The doorway must be cut out of the wall, so you'll need to make the doorway object negative.

To add Boolean properties:

- 1 Press the N key to make the doorway object negative.
The wireframe changes to a dotted line.
- 2 Switch to Top View.
- 3 Select the front wall by clicking it.
The wireframe turns red.
- 4 Press the P key, to change this object's properties to positive.
- 5 Select both the front wall and the doorway by drawing a selection marquee around their centerpoints.

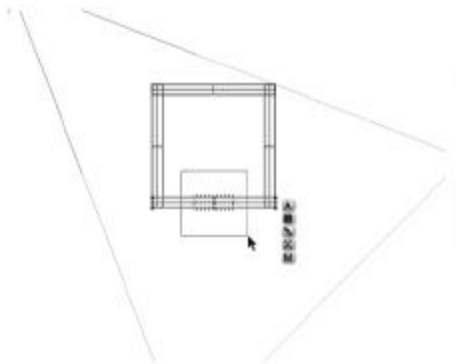

Creating a Boolean object

- 6 Click the Group button to group them.
The G changes to a U and the family color changes to Default Gray.
Since this group is part of the Wall family of objects, it's a good idea to assign the group to the Wall family.
- 7 Click the Family button on the Selection palette to access the Family dialog box.

- 8 Select the Wall family.
- 9 Click the OK icon to exit the dialog box.
The Family button changes to the Wall wireframe color.
- 10 Click the Solo Mode button to exit solo mode.
The rest of your scene appears.
- 11 Change to Director's View.
- 12 Click the Render button.
You may need to adjust the walls if there is a gap between the walls and the roof.
- 13 Save your scene.

GROUP AND GROW THE ENTIRE BUILDING

Since you'll be placing objects inside this building and eventually flying through it with the camera, the building needs to be bigger. When you enlarge the entire object as a group, the individual objects retain their relative size and position.

LESSON 22: GROUPING THE BUILDING

To group the building:

- 1 Choose Edit menu > Select All (or command/Ctrl+A).
All of your objects, including the ground, are selected.
- 2 Hold down the Shift key and click the ground to deselect it.
The selection bounding box encloses only the pyramid group and the wall objects. The Group button is showing.
- 3 Click the Group button to group these objects.

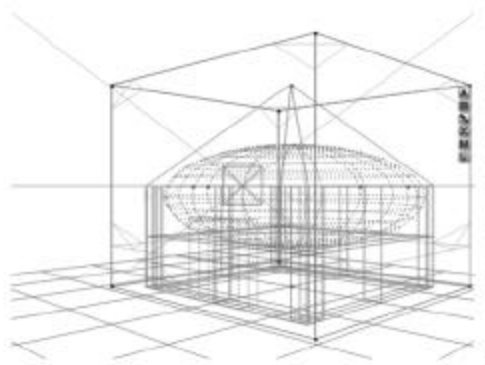

Grouping the building

- 4 Press the * key twice (Shift+8).
Each time, your group's size doubles.
- 5 Click the upward pointing arrow button (located with the group of buttons associated with the bounding box of the selected object).
The group jumps up so that it is now resting at ground level.

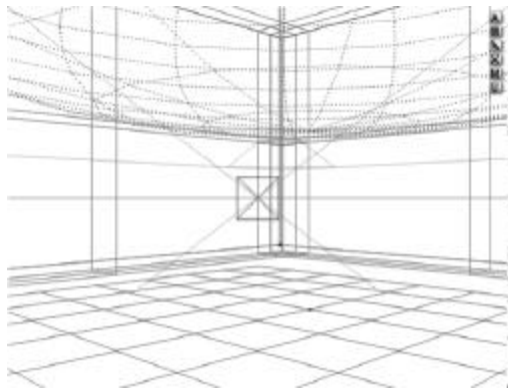

Positioning the building

LESSON 23: CHANGE YOUR VIEWPOINT OF THE SCENE

You need to adjust your viewpoint of the scene so that you can see the entire building.

To change viewpoint:

- 1 Place the cursor over the Trackball control on the Controls palette.
The cursor changes to double crossed arrows.
- 2 Click and drag the Trackball to the right.
The scene rotates counter clockwise in the scene window.
- 3 Continue dragging until the blue camera wireframe is on the left side of the window and the center wireframe lines of the front and back walls line up in the center of the window, looking like the following figure.

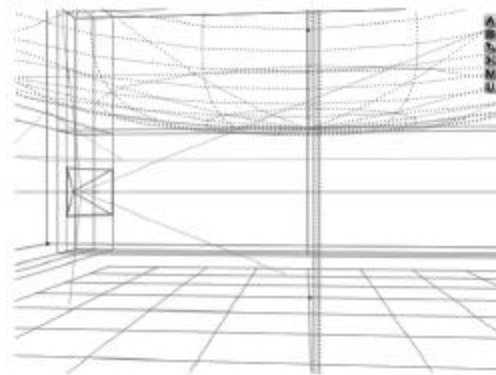

Changing the viewpoint

You are now looking through the doorway of the building,

- 4 Place the cursor on the bottom Z arrow of the XZ Camera control.
- 5 Drag up on the XZ Camera control until you can see the entire front wall of the building.
The scene should look like this.

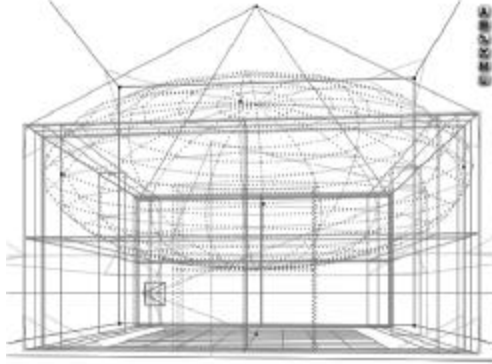

Changing your viewpoint.

- 6 Save your scene and call it Grouped Building.

SPHERE ON A PEDESTAL

The next section of this tutorial will incorporate an existing scene file. This image will be merged into the scene you are creating.

LESSON 24: MERGING AN EXISTING SCENE

TO MERGE ANOTHER SCENE:

- 1 Select File menu > Merge.
- 2 In the Open dialog, navigate to the Manual Tutorial folder on the Bryce 5 CD-ROM.
- 3 Select the scene file called Pedestal Merger.
- 4 Click the Open button.

The Wireframe for the merged scene appears in your scene, and is selected.

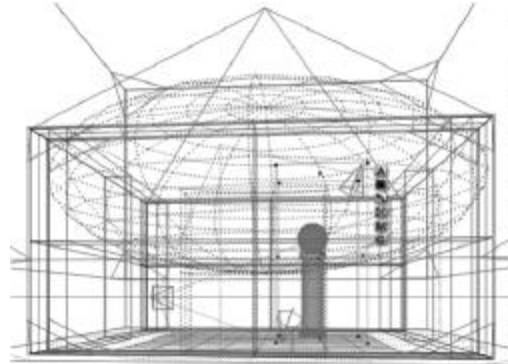

The merged scene

- 5 Render the scene.

There is now a pedestal with a mirrored sphere on it. There are lights in the scene as well.

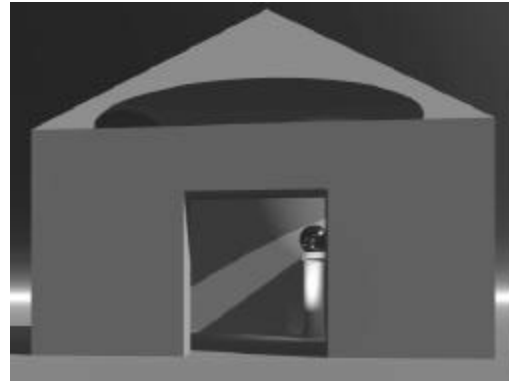

The rendered scene

LESSON 25: ADJUSTING LIGHTS

In this next lesson, you will make slight modifications to the lights and use Bryce's tracking controls to make the lights always point at certain objects. To make it easier, you'll need to temporarily rid your scene of some extra objects.

TO ADJUST LIGHTS:

- 1 Click the Solo Mode button on the Selection palette to change to Solo mode.

The ground, walls and building objects disappear, leaving only the two lights and the pedestal and sphere.

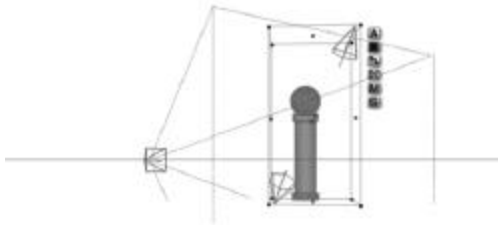

The scene in Solo mode

- 2 Click away from the objects to deselect them
- 3 Select the lower light.

The fourth button down (in the group of buttons associated with the selected object) is the Tracking icon.

- 4 Click the Tracking icon (the fourth button down in the group of buttons associated with the selected object) and drag from it to the sphere object.

While your mouse button is still pressed, whatever object is underneath the cursor turns blue.

- 5 Release the mouse button when the sphere turns blue.
The light is now set to track the sphere.
- 6 Drag the light so that it is located above and to the left of the sphere.
The light remains pointing at the sphere.
- 7 Click the Land Object button (the Down arrow button located in the group of buttons associated with the selected object).

The light snaps to the ground, pointing toward the sphere from this position.

- 8 Select the light that is located above and to the right of the pedestal.
- 9 Drag from this light's Tracking icon to the tall cylinder.
- 10 Release the mouse button when the tall cylinder turns blue.
- 11 Drag the light down slightly to the right.

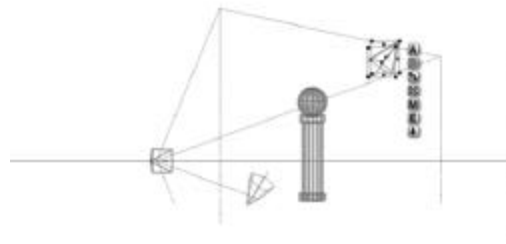

Repositioning a light

- 12 Click the Solo Mode button to exit Solo Mode.
- 13 Render and save your scene.

PRE-PRODUCTION

In this section of the tutorial, you will plan the creation of an animation.

You'll work on some pre-production tasks. Then you will animate the camera, tweak the animation, and conduct test renders.

You can use either the the scene you created in this tutorial, or the file entitled Animation-start on the Bryce 5 CD.

LESSON 26: PRE VISUALIZING AND TIMING THE SEQUENCE

The pre-production phase is where you plan the sequence of events.

Up until now, you've been working with your scene in Director's View and in the different orthogonal views. For animating you will use Camera View.

To plan and time the sequence:

- 1 On the Controls Palette, choose Camera Options menu > Camera to Director.

The camera wireframe disappears from the scene. The camera object has moved to the same location as the Director's View, so it is now located at your point of view.

- 2 Switch to Top View.

Your scene changes to top view. The camera is now located at the bottom of the scene window.

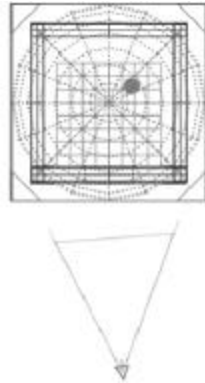

The top view

In this animation, the camera will go through the doorway, circle around the pedestal, then go out through the archway just above the left wall.

- 3 On the Display palette, (to the right of the Working Window) click the Demo marker tool.
- 4 Beginning at the camera's location, drag the mouse to draw a path from the camera, through the door, around the pedestal, and out the left side. Your scene should look something like this.

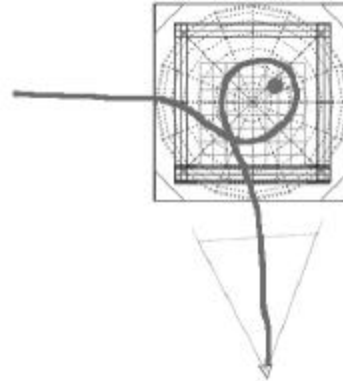

Drawing the path

For this example, let's assume that this path will take 9 seconds for the camera to travel.

- 5 Press the space bar to remove the marked path.

LESSON 27: SETTING UP THE TIMELINE FOR THE SEQUENCE

Now that you have decided that the animation will take 9 seconds, it is time to set it up and begin animating the camera.

To set up the timeline:

- 1 Choose File Menu menu > Animation Setup.
- 2 In the dialog, enter 9 seconds in the Duration section, and change the frames per second (FPS field) to 10.

When you exit the dialog box, the Time Scrubber and Current Time Indicator on the Animation palette fill with a blue timeline.

The blue extends beyond what is visible in the Time Working area. You will use the Scale tool above the right end of the timeline to scale the timeline so that you can see it.

- 3 On the Scale tool, drag the cursor to the right.



The Scale tool

The tick marks move closer together and more of them appear from the right.

- 4 Continue dragging until you can see the entire blue portion of the timeline.
- 5 If the Selection palette is showing, toggle to the Animation palette by clicking the Selection Animation toggle in the lower right corner of the Bryce interface.
- 6 Click the triangle on the right side of the Animation palette, ensure Auto-key is selected.
- 7 Click the triangle again and select Ticker Marks > Every 5 Frames.

When your frame rate is 10 frames per second, a ticker mark every 5 frames is equivalent to a ticker mark every half a second.

ANIMATE THE CAMERA

LESSON 28: SETTING THE CAMERA TRAJECTORY

TO ADJUST THE CAMERA'S TRAJECTORY:

- 1 Click the Add Keyframe (+) button to add a keyframe to the beginning of the timeline.
- 2 Drag the Scrubber three ticks to the right.
The time reading is 00:00:01.05.
- 3 Place the cursor over the camera. Ensure that the cursor is a single arrow and not a cross arrow.
Do not drag the camera by the blue handle in the center of the camera; you will be dragging and adjusting the actual key position rather than the camera itself.
- 4 Drag the camera to the interior of the room, as shown.

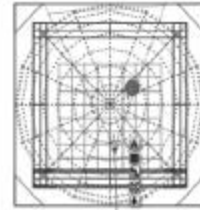

Positioning the camera.

A blue point appears where the camera was just located, and a blue trajectory line links the first point with the new camera location.

The trajectory is the line along which the camera will move.

- 5 Drag the Scrubber another three ticks to the right.

The time reading is 00:00:03.00.

- 6 Drag the camera so that it is on the left side of the mirrored sphere wireframe.

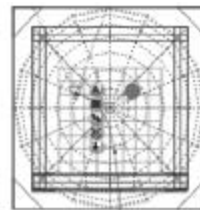

Drag to the next position.

- 7 Drag the Scrubber another three ticks to the right.

The time reading is 00:00:04.05.

- 8 Drag the camera so that it is on the far side (top) of the sphere wireframe, as shown.

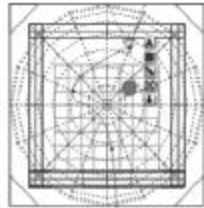

Another camera location.

- 9 Drag the Scrubber another three ticks to the right.

The time reading is 00:00:06.00.

- 10 Drag the camera so that it is on the right side of the sphere wireframe.

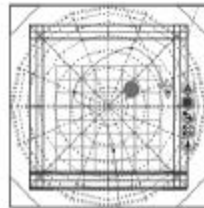

Yet another camera location

- 11 Drag the Scrubber another three ticks to the right.

The time reading is 00:00:07.05.

- 12 Drag the camera so that it crosses to the left of the path as shown.

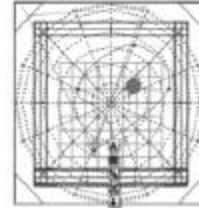

Continuing the trajectory

- 13 Drag the scrubber the final three ticks to the right to the end of the timeline.

The time reading is 00:00:09.00.

- 14 Drag the camera well beyond the wireframe to the left of the building, as shown.

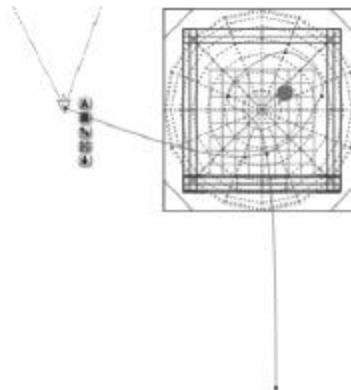

Finishing the path

Congratulations! You have just created a camera trajectory to animate this camera.

You'll no longer need the Bryce's Auto-key function. To ensure that you do not inadvertently create a new keyframe during the next steps of this tutorial, you can deactivate this function.

- 15 Click the triangle to the right of the Animation palette.
- 16 Deselect Auto-key from the list.

LESSON 29: POINTING THE CAMERA

Check to see how the camera moves by playing the sequence.

To play the sequence:

- Click the Play button on the Animation palette.
The camera moves along the blue trajectory while the Time scrubber moves from left to right. Notice that throughout the animation, the camera faces in one direction.

To point the camera:

- 1 Toggle back to the Selection Palette by clicking the Selection Animation toggle in the lower right hand corner of the Bryce window.
- 2 Click and hold the Select Sphere tool.
- 3 Choose the last sphere on the list that appears.
This should select the pedestal sphere in the merged scene. Make a note of the sphere's name; you will find it in a different pop-up menu in the next couple of steps.
- 4 Click the camera to select it.
The camera's wireframe turns red and the blue trajectory line appears.
- 5 Click the Object Attributes button.
- 6 Click the Linking tab.
A new panel appears with options for Object Parent Name and Track Object Name.
- 7 Click the box titled 'None', under Track Object Name.
- 8 Select the name of the pedestal sphere.
- 9 Click the OK icon to leave the Camera's Object Attributes dialog box.

The camera snaps to the right to point at the sphere, and a gray line extends from the camera to the sphere.

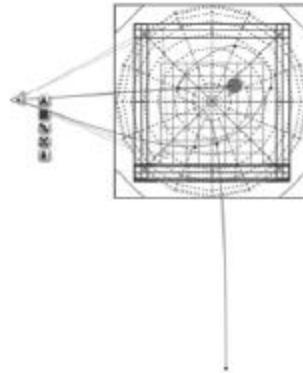

A line extends from the camera to the sphere

- 10 Toggle back to the Animation palette.
- 11 Click the Play button.
The camera moves along the trajectory, facing the sphere for the entire duration of the sequence.

To view the scene from camera view:

- 1 Switch to Camera View.
- 2 Click the Play button to watch the wireframe animation.
The camera flies through the space, all the while keeping the sphere at the center of the scene window.
- 3 Save your scene, call it Animation-Rough Cam.

LESSON 30: MAKING CAMERA ADJUSTMENTS

The height of the camera fly-through is below the mirrored sphere and below the open arch on the left side of the building. However, the camera trajectory may have some kinks in it. You can drag the points of the camera trajectory to reshape it.

To adjust the height:

- 1 Switch to the From Right view.
- 2 Click the Zoom out tool, to see the entire camera path.

First, you'll adjust the camera's height so that it is level with the sphere as it circles around it.

- 3 Drag the point on the right up so that it is level with the sphere.

Your scene should look like the following figure.

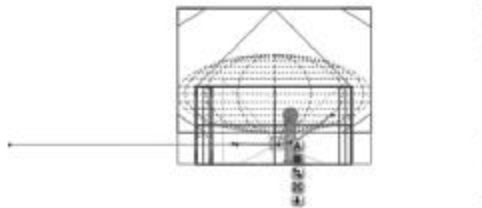

Adjusting the height.

- 4 Drag the other points up, except for the first and last.

Your scene should look like the following figure.

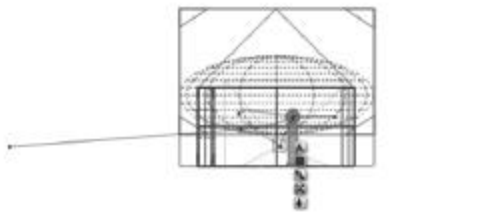

Adjusting the camera view

To continue adjusting, you will need to look at the scene from a different perspective.

- 5 Switch to From Front view.

Zoom out if needed.

- 6 Drag the endpoint of the camera trajectory up so that it extends from the sphere through the Boolean sphere and beyond the building.

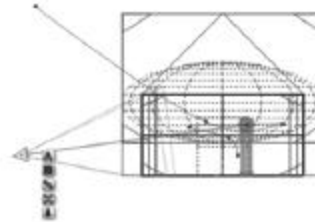

Fine-tuning the adjustments

Note that you might need to Zoom out here to see the same view as the image above. The dotted line of the sphere is the location of the open area of the arch.

- 7 Click the Play button.

Watch the camera's movement through the sequence. The camera ends up at the position you set at the previous step.

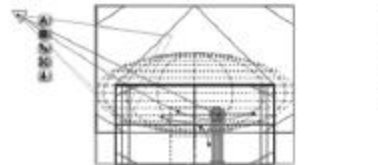

The camera's endpoint

Now that the camera is back on the trajectory, notice that the gray line between the camera and the sphere provides a guide for that straight line of sight. You can use the guide for other placements of your trajectory.

- 8 Drag the previous key point up so that it is aligned with that gray line. Your trajectory should look like the one shown.

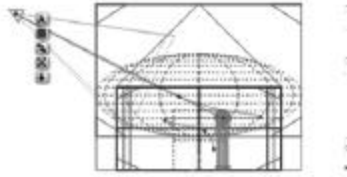

Positioning the key point.

- 9 Switch back to Camera view.
- 10 Click the Play button to see your animation.

LESSON 31: SMOOTHING THE CAMERA'S TRAJECTORY

To smooth the Camera's trajectory, you will adjust the points and work with the shape of the curve using the tangents of each point. To see the tangents, you will need to make them visible.

To display the trajectory options:

- 1 Switch to Director's View.
- 2 Click the Object Attributes button to access the Camera and 2D Options.
- 3 Click the Animation tab.
- 4 Under Trajectory Options, click the button for Show Always.
- 5 Click the button for Show Tangents.
- 6 Exit the Camera and 2D Projection dialog box by clicking the OK icon.

The camera trajectory now has green lines extending from each point.

To smooth the trajectory:

Smoothing the trajectory is easiest when you work in Top View.

- 1 Switch to Top View.

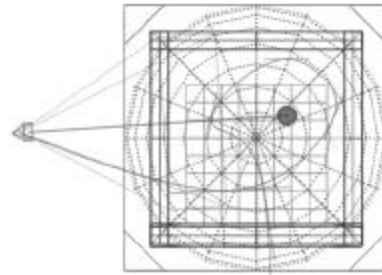

The top view

- 2 Toggle to the Selection palette.
- 3 Click the Select Families button.
- 4 Choose the Walls family.
- 5 Holding down the Shift key select Pedestal from the Families list.
- 6 Click the Solo Mode button.

There is now a much clearer view of your camera trajectory and the tangents extending from each point.

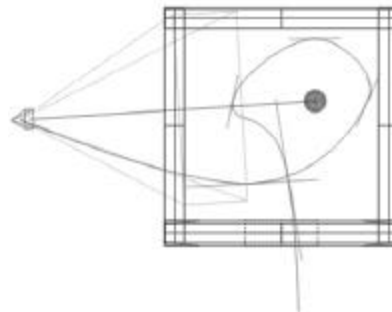

The trajectory path

Any kinks in the path result from a lengthy tangent interfering with a neighboring point. Shortening the tangent will smooth out the trajectory line.

- 7 Click the camera to select it.
The points appear.

- 8 Place the cursor over the point with the longest trajectory.
The cursor changes to crossed arrows.
- 9 Press the T key (for tangent), then click and drag to the right.
The tangent lines shorten.
- 10 Reposition any points to smooth out the trajectory line.

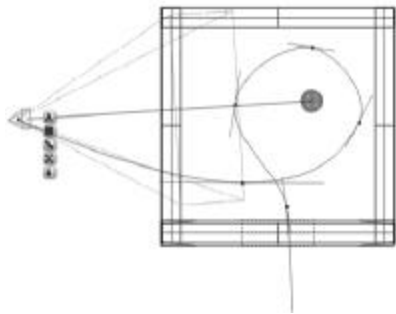

Adjusting the trajectory path

- 11 Click the Solo Mode button.
- 12 Switch back to Camera View.
- 13 Toggle back to the Animation palette.
- 14 Click the Play button to view the animation.
- 15 Save your scene.

LESSON 32: TEST RENDER

It's time to set up a test render of your animation sequence. Continue with the scene file you have been working with, or use the Animation-Smooth Cam scene file from the CD.

To create a rough animation, you need to change the render size of your scene to a smaller image.

TO CREATE A TEST RENDER:

- 1 Choose File menu > Document Setup.

- 2 In the dialog box, change the render resolution to 1:0.25.
- 3 Click the OK icon to exit the dialog box.
- 4 Click the Render button to test render your scene.
- 5 Choose File menu > Render Animation.
This dialog box allows you to choose your settings for this test render.
- 6 In the Output Module section, click the Edit button.
A Compression Options dialog box appears.
- 7 Disable the option for Keyframe every 10 frames then click OK.
- 8 Click the Set button.
A Save dialog box appears, showing the location and name of your movie.
- 9 Choose the location and name of your movie.
- 10 Click Save.
- 11 Click the OK icon to exit the Render Animation dialog box.
Your scene begins rendering each frame. At the end of the render, Bryce automatically launches the movie player application.



Playing the animation

- 12 Click the Play button to watch your animation.
- 13 Switch back to Bryce and save your scene file.

Congratulations! You've created your first Bryce movie! Make sure that you exit the movie player application before you continue the tutorial.

FINE-TUNING YOUR ANIMATION

To finish your animation, you will convert your trajectory to a path. In the beginning, you used key frames to set the position of the camera. This trajectory is good for creating the physical location of the camera over the sequence. However, the points along the path tend to correspond to places, and not necessarily events, or velocity.

Converting to a path will allow you to set up two key frames, one for the beginning and the other for the end, and you can adjust the velocity without worrying about the placement of a keyframe at that spot.

LESSON 33: CONVERTING THE TRAJECTORY TO A PATH

To work on the timing and velocity of your sequence, you will convert your trajectory into a single path object.

TO CONVERT FROM TRAJECTORY TO PATH:

- 1 Switch to Top View.
- 2 Select your camera by clicking it.
- 3 Choose Objects menu > Create Path.
A new path object appears, occupying the same space and shape as the camera trajectory.
- 4 Select the camera again.
- 5 Click the triangle on the Selection Palette.
- 6 Choose Camera to select the camera (Notice that there is an option there for selecting paths as well).
The Camera and its trajectory line are selected.
- 7 Click the Object Attributes button.
- 8 Click the Linking panel.
- 9 For Object Parent name, select Path 1 from the pop-up menu of your objects.

- 10 Click the button next to Constrain to Path.

- 11 Click the OK icon to leave the dialog box.

The blue trajectory line disappears.

The trajectory line went away when the camera was constrained to the path. All of the key-framed motion information for the camera went away with the trajectory.

The location information of the trajectory is preserved in the path, which is present in your scene.

- 12 Click the Selection Animation toggle to switch to the Animation palette.

- 13 Click the Play button.

The scrubber moves, but the camera does not.

You'll re-set the key frames for camera motion for the beginning and end of the sequence.

LESSON 34: CREATING KEYFRAMES FOR THE BEGINNING AND END OF THE PATH

TO CREATE KEY FRAMES:

- 1 Click the Time First Keyframe button on the Animation palette.

The scrubber moves to the beginning of the sequence (time 00:00:00.0).

- 2 Click the Add Keyframe button.

- 3 Click the Last Keyframe button.

The scrubber moves to the end of the sequence (time 00:00:09.0).

- 4 Click the camera to select it.

- 5 Click the Object Attributes button.

- 6 Type the number 100 in the Position box.

- 7 Click the OK icon.

Your camera should now be located at the end of the path.

- 8 Click the Add Keyframe button.

- 9 Check your animation, by clicking the Play button.

Your camera should now move smoothly along the path.

You now have very smooth camera movement over a complex path, using only two key frames.

LESSON 35: VELOCITY ADJUSTMENT

The last thing you will do with your animation in this tutorial is adjust the camera's velocity along the path. To do this, you will work in Bryce's Advanced Motion Lab.

Your camera should be selected.

To ADJUST THE VELOCITY:

- 1 Click the Advanced Motion Lab button.
On the bottom half of the Advanced Motion Lab, the objects and their timelines are displayed. The round button at the upper right of the timelines is the current time display. Because of the length of the animation, you can't see the entire timeline for this sequence.
- 2 Drag the round Current Time display marker to the left.
The numbers and timeline bars scroll off to the right.
- 3 Continue dragging left until the marker is at the left end of the timeline.



Adjusting the timeline

- 4 Drag the Scale tool to the right. (It is located under the preview window.)

The space between numbers decreases, and after a bit, the entire timeline is displayed.

- 5 Release the mouse button.



Adjusting the scale

The word camera displays in red.

- 6 Click the word Camera.
- 7 Click the word Position.

Additionally, in the Velocity Controls section (also known as the Time Mapping curve), a diagonal line has appeared.

Next to the window to the right is a camera icon and a light icon.

- 8 Click the camera icon.

A green light appears and the display in the right window changes to show your scene from the camera's perspective.



The camera's perspective

See how the animation preview and the Velocity area work together.

- 9 Click the Play button under the animation preview window.

The animation plays, while crosshairs mark the current time along the Velocity line.

You'll use one of the preset Velocity curves to put a little variety in the camera motion.

- 10 Click the slight S-shaped curve that matches the one shown, from the Velocity Controls section.

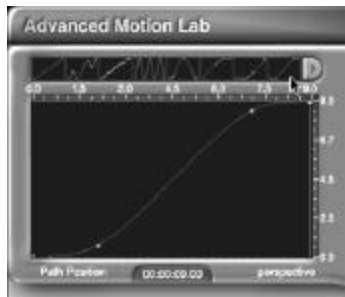

Velocity curve

- 11 Click the Play button.

The animation begins slowly, moves faster for a time and then slows down toward the end.

When the velocity curve is flatter, camera motion is slower. When the curve is steeper, the motion is swifter.

- 12 Click the arrow in the lower right corner to leave the Advanced Motion Lab and return to your scene.
- 13 Save your scene file.

LESSON 36: ANOTHER TEST RENDER

Before your test render, double-check your render settings.

To render:

- 1 Choose File menu > Document Setup.
- 2 In the Document Setup dialog box, ensure that you are rendering at the smallest ratio: 1:0.25.
- 3 Switch back to Camera View.
- 4 Select File menu > Render Animation.

- 5 In the Render Animation dialog, change the name of this test file to Render 2.
- 6 Click the Set button.
- 7 In the Save dialog box, add "test path" to the name.
- 8 Click Save.
- 9 Click the OK icon to exit the Render Animation dialog box.

Your animation begins rendering.

FINAL COMMENTS

Compare the two test animations. Do you see the difference in movement?

For your final render, you may render at a larger size, or, for fun, try creating a Volumetric World to add drama to those light rays that enter the building through the arches.

Congratulations! You have now created a scene, set up your animation, created the camera trajectory, converted the trajectory to a path, and adjusted the camera's velocity on that path. You have walked through a fair portion of the power of creating and animating Bryce scenes.

For additional ideas about how to animate this scene or for other tips, check out the websites under the Links menu.

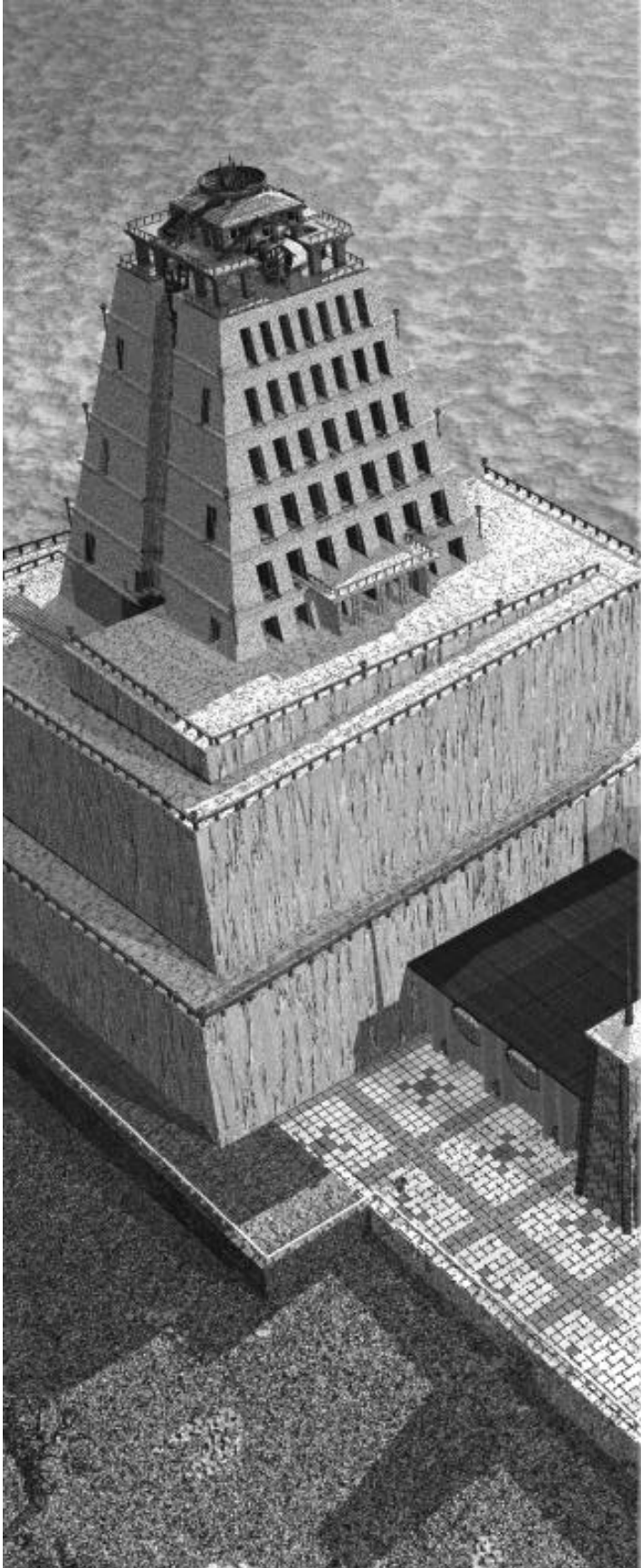

4

CREATING OBJECTS

Objects are the building blocks of your Bryce world. They can be used as props, to populate a scene, or to add detail to landscapes.

An object is the most basic item in Bryce. Objects can be anything from terrains to pebbles. In Bryce, there are several ways of creating objects. Some objects use unique editors; others can be created by a simple one-step click.

There are two main tools for creating objects. The Create palette, which contains tools for creating objects with a single click, and the Preset Objects Library, which contains pre-made objects you can add to your scene.

THE CREATE PALETTE

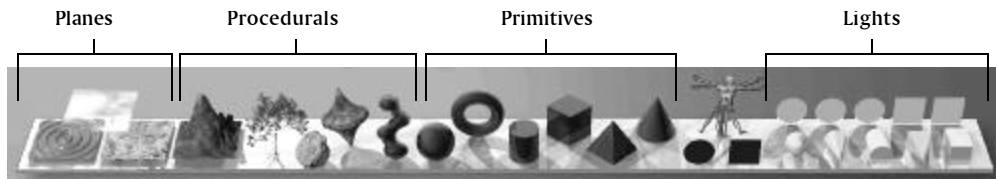

The main tool for creating objects is the Create palette. This palette provides access to tools that let you create all the object types available in Bryce.

The tools on the palette represent the type of object they create. The name of each tool appears in the Text Display area as you move your cursor over it. When you click a tool, the object appears in the center of the scene.

To display the CREATE PALETTE:

- Click the Create button at the top of the Bryce window.

To use a CREATE TOOL:

- 1 Display the Create palette.
- 2 Click on the tool for the object type you want to create.

The object appears in the working window.

The Triangle icon next to the Create button at the top of the Bryce window lets you access the Preset Objects Library.

To open the PRESET OBJECTS LIBRARY:

- Click the Triangle icon next to the Create button at the top of the Bryce window.

PRIMITIVES VS. PROCEDURAL OBJECTS

Bryce's Create palette lets you create two different types of basic object: Primitives and Procedurals.

Primitives are basic geometric shapes such as the sphere, torus, cylinder, cube, pyramid, cone, plane, and disk. These shapes can be thought of as primary geometric building blocks, from which more complex objects are constructed.

Primitives also have derivative groups (such as the ellipsoid and squashed sphere, which are derived from the Sphere), which allow you to create different shapes without having to perform the transformations yourself.

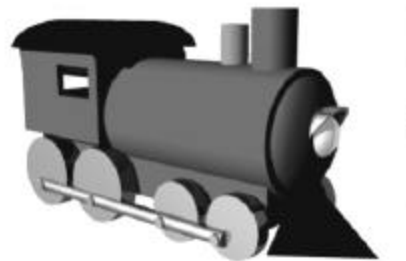

This train is made up of primitive and primitive derivative objects.

Procedural objects are object that require special constructions, or “procedures,” to create, such as terrains, trees, rocks, symmetrical lattices, and Metaballs. Procedures can include operations such as preassigning materials, randomizing internal parameters, or assigning light properties.



This scene shows examples of procedural objects.

CREATING PRIMITIVES

Primitives are the primary geometric building blocks in Bryce. You can create spheres, tori, cylinders, cubes, pyramids, cones, discs, and 2D faces.



Creates spheres



Creates tori



Creates cylinders



Creates cubes



Creates pyramids



Creates cones



Creates discs



Creates 2D faces

By default all primitives are assigned a flat gray color.

TO CREATE A GEOMETRIC PRIMITIVE:

- Click one of the primitive tools:

DERIVATIVE PRIMITIVES

Derivative primitives are primitive objects whose shape is “derived” from basic geometric primitives.

Derivative primitives were created so that you could skip some of the editing procedures on most of the basic primitives. For example, instead of elongating a cube to make it into a pillar, you can just use the Stretched Cube derivative. Instead of shortening a cube to make it into a rectangle, you can use the Squashed Cube derivative.

TO CREATE A STRETCHED PRIMITIVE:

- Press Shift and click the primitive tool.

TO CREATE A SQUASHED PRIMITIVE:

- Press Command/Ctrl and click the primitive tool.

OBJECT PLACEMENT

When you create a new object it can be placed in your scene either at absolute world center or at an arbitrary location based on your current view. Object placement is determined by your preference setting. Refer to “To control new object placement:” on page25 for more information.

SELECTING OBJECTS

Before you can perform any type of editing or transforming operation on an object, you need to select it. As well as selecting objects using the cursor, Bryce’s Selection tools let you select objects by type or family. You can also cycle through all the objects in your scene.

To select an object:

- Click on any object. A selected object's wireframe will appear red.
or
- Drag a marquee around the object.

To step through all the objects in your scene:

- Press the Tab key until the object you want selected appears in red.

To select a number of objects:

- Drag a marquee around a number of objects.

To select an object within a group:

- Hold down Control/Ctrl and click the desired object.

To select all objects:

- Choose Edit menu > Select All, or
- Press Command/Ctrl+A.

To deselect all:

- Choose Edit menu > Deselect All, or
- Click anywhere outside the selected area.

To add objects to a selection:

- Hold down the Shift key while selecting the object.

To remove objects from a selection:

- Hold down the Shift key and click the selected object.

To select obscured objects:

- 1 Hold down the Shift key and select through the obscuring object.

All objects underneath the cursor will be selected. If the obscuring object is already selected, it will be deselected and all the objects behind it will be selected.

or

Hold down Command/Ctrl and click an object to select or deselect. Use Shift to select multiple objects.

You will see a list of all objects under the cursor. This lets you not only view the selection status of all the listed objects, but change it as well. This aids in dealing with large scenes.

THE SELECTION PALETTE

The Selection palette is hidden behind the Animation controls in Bryce's default state. The palette is divided into two sections: select by type tools and the VCR controls.



The Selection palette has tools for selecting objects in a variety of ways.

To display the Selection palette:

- Click the Time Selection Palette toggle in the lower-right corner of the Working window. The Selection palette appears.

SELECTING BY OBJECT TYPE

The Select by Type icons let you select all the objects in your scene that are of a particular type. For instance, if you click on a sphere here, Bryce will select all spheres and sphere-derivative objects in your scene.

All of the selection controls below respect the previously described Shift-click techniques for multiple selections and deselections.

To select a specific object by type:

- Hold down the cursor over the tool for the type of object you want to select and choose the name of the object from the menu that appears.

By default, objects will be named with the object type followed by a sequential number

based on when you placed that object in the scene; for example, Sphere 1. To make it easier to select a particular object, you can give objects unique names that will appear in this menu. Refer to “Naming Objects” on page 69 for more on naming objects.

To select objects by family:

- Click the Families tool and choose the name of the family you want to select from the menu.

To select Mesh objects:

- Click the triangle icon next to the Selection palette and choose Select Mesh.

To select Path objects:

- Click the triangle icon next to the Selection palette and choose Select Path.

To select Group objects:

- Click the triangle icon next to the Selection palette and choose Select Group.

To select all objects except a specific type:

- 1 Click the tool for the object you want to exclude from the selection. All the objects of that type are selected.
- 2 Click the triangle icon in the Selection palette and choose Select Inverse from the menu.

To select all the objects in your scene:

- Click the triangle icon in the Selection palette and choose Select All from the menu.

THE VCR CONTROLS

The VCR controls let you step through the various selection tools and activate Solo Mode.



To display the VCR Controls:

- 1 Click the Time Selection Palette toggle in the lower-right corner of the Working window. The Selection palette appears.
- 2 Pass your cursor over the right side of the Selection palette. The VCR Controls appear.

To step forward and backward through the object types in your scene:

- 1 Click on the larger forward arrow to step forward through object types within the current scene. The first object of its type is selected.
- 2 Click on the larger backward arrow to step back through object types.

If you watch the Select By Type icons, the object type you are stepping to will highlight momentarily.

To step forward and backwards through the object in a selected object type:

- 1 Click on the smaller forward arrow to step forward through each object of the type in a selection.

For example, you can use the large arrows to step to the first sphere created in your scene, and then the smaller arrows to step through all other spheres in your scene.

- 2 Click the smaller backward arrow to step backward through each object of the type in a selection.

One advantage to making selections with this technique is that you can select objects within a Group. Simply clicking on a Grouped object will not necessarily select the entire group; using the VCR controls to select within a Group allows you to reposition objects, or assign textures to objects within a Group without having to first Ungroup them.

To STEP SEQUENTIALLY THROUGH EVERY OBJECT IN YOUR SCENE:

- 1 Click the triangle icon in the Selection palette and choose Alternate VCR Mode.
- 2 Click the larger backward or forward arrow.

To STEP SEQUENTIALLY THROUGH FAMILIES:

- 1 Click the triangle icon in the Selection palette and choose Alternate VCR Mode.
- 2 Click the smaller backward or forward arrow.

To TEMPORARILY REMOVE ALL UNSELECTED OBJECTS FROM THE SCENE:

- 1 Select an object.
- 2 Click the Solo Mode button in the center of the VCR controls. The button color changes to red.

In Solo Mode, you can only edit the selected objects; all the other objects remain in place but uneditable.

If you're working on a very complex scene, Solo Mode speeds up your work significantly, as Bryce does not have to calculate and draw extraneous wireframe objects.

THE OBJECT ATTRIBUTES DIALOG

The Object Attributes dialog lets you set a number of properties that determine how the object appears in the Working window.

The dialog is where you'll set up the object's name, size, orientation, placement and display quality. It's most often used to numerically transform the object. When you're animating an object, the dialog is used to control how the object interacts with its motion path. Refer to "Animating" on page319 for more on animating.



The Object Attributes dialog contains controls for setting the object's name, scale, position, and orientation.

The dialog is divided into three tabs: General, Linking, and Animation.

The General tab contains controls for setting the object's name and display attributes and position. Refer to "Editing Object Attributes" on page230 for more on using the dialog to edit objects.

The Linking tab contains controls for setting up parent-child links and tracking. Refer to "Linking Objects" on page223 for more on linking and "Tracking Objects" on page344 for more on tracking.

The Animation tab lets you set the properties of the object when it is connected to a Motion Path. Refer to "Animation and Motion Paths" on page320 for more on motion paths.

To display THE OBJECT ATTRIBUTES dialog:

- 1 Select an object.
- 2 Click Objects menu> Attributes.
or
Click the Aicon that appears next to an object's bounding box.

NAMING OBJECTS

When you create an object, the first thing you should do is assign a name to it. An object's name identifies it in the Working window.

You can select objects, by name, using the Selection palette. The name can also help you distinguish a specific object when your scene contains more than one object of the same type. Refer to "Selecting Objects" on page 65 for more information.

An object's name is also used when you're creating parent-child links and setting up object tracking.

TO NAME AN OBJECT:

- 1 Select an object.
- 2 Click the Aicon that appears next to its bounding box.

OBJECTS IN THE SCENE

Every object in the scene has a bounding box. The box acts like a visual guide that tells you how much space it occupies in 3D space. It also provides access to a series of tools that let you edit an object's attributes and placement.

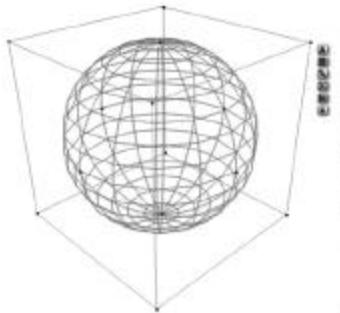

An object's bounding box lets you see how much space it occupies in 3D space.

The buttons around the edges let you set an object's attributes.

The black points on the edges of the box are called *control handles*. These handles can be used to edit the object's size and orientation. As you pass your cursor over the handles, it changes to display the type of control you're selecting.

When the cursor turns into a letter, it means that you're over a constrain handle. The handle will only move along the axis indicated by the letter. For example, if the cursor changes to a Y, it means that the handle will move only along the Y axis.



If your cursor changes to a letter, it means that you're over a constrained control handle.

You can drag this type of handle to distort the shape of the object.

If the handle changes to a black square with a right angle, it means that the handle can move in any direction, but the object will be scaled proportionally.

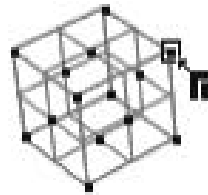

If your cursor changes to a black box with a right angle, it means that you can use the handle to proportionally scale the object.

TO display AN OBJECT'S BOUNDING BOX:

- 1 Create an object.
- 2 Select the object.

Object Preview

When you create an object, it appears as a wireframe in the Working window. The wireframe represents the structure of the object's shape.

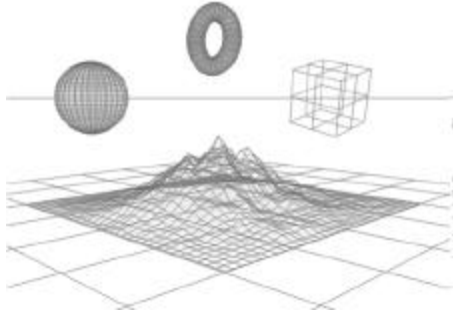

Objects appear as wireframes in the scene. The wireframe gives you an idea of the object's shape and structure.

The wireframe preview lets you see how an object looks as it's being rotated or animated without having to calculate and render any complex surface properties. The wireframe casts a shadow on the ground plane below it. The shadow can be used as a visual guide to help you determine the object's position in 3Dspace.

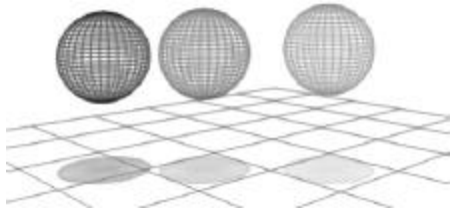

As you move the object its shadow follows it along the ground plane. When you have a number of objects, the shadows can help you see its exact position in the scene.

If you move the object below the ground plane, the portion of the object that's below ground is not drawn. This can help you avoid placing an object outside the view of the scene. Wireframe shadows do not interact with light; they appear regardless of the light sources in the scene.

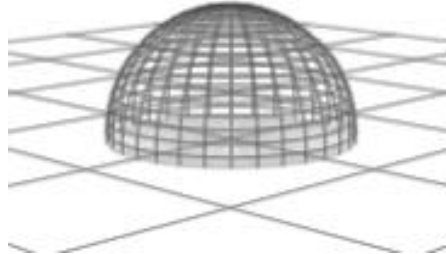

If you move an object below ground, the portion of the wireframe that's below the ground plane is not displayed in the scene.

Both shadows and underground wireframes are preview options that can be turned on and off. Refer to "Wireframe attributes" on page 27 for more on these features.

Object Preview Modes

In addition to wireframes, there are three other ways you can view an object: Bounding Box, Shaded Preview, and Rendered Preview.

Bounding Box

If you have a large scene and you find that it's taking too long to redraw the entire scene, you can change the display of the objects so that only their bounding boxes are displayed.

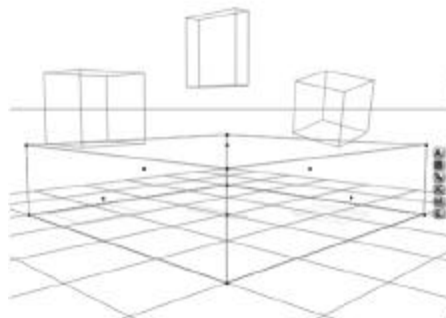

The Show Object as Box preview mode displays the object using only its bounding box.

You can move the box just as you would a normal object. The box can also cast a shadow.

To display AN OBJECT AS A BOX:

- 1 Select an object.
- 2 Click Objects menu> Show Object as Box.
or
Click the Aicon that appears next to the object's bounding box to display the Object Attributes dialog.

In the dialog, click the Show as Box button.

To display AN OBJECT AS A WIREFRAME:

- 1 Select an object.
- 2 Click Objects menu> Show Object as Lattice.
or
Click the Aicon that appears next to the object's bounding box to display the Object Attributes dialog.

In the dialog, disable the Show as Box button.

SHADED PREVIEW

Open GL mode performance is greatly increased from an Open GL accelerator card, but Windows 95/98 and Windows NT® also support software-driven Open GL mode.

In this mode, objects appear as solids. The colors assigned to the object are also visible. Object surfaces are affected by light sources. Materials and textures are not visible in this mode.

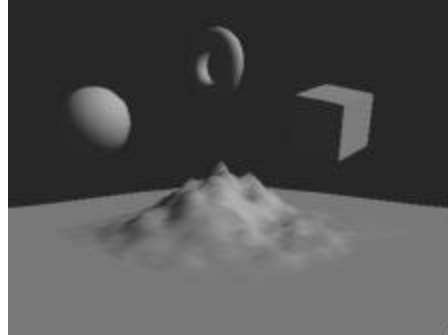

In the shaded preview mode you'll be able to see all the objects in your scene as solids.

RENDERED PREVIEW

If you want to see what the object's surface looks like or how it is affected by light gels, you'll have to render it.

The Nano-Preview shows you a small preview of what the object looks like rendered.

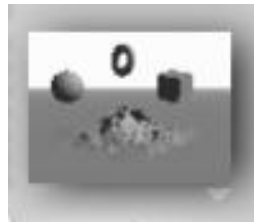

The Nano-Preview of the object shows you a small preview of what the object will look like when it is rendered.

Refer to "Using the Nano-Preview" on page19 for more on the Nano-Preview.

If you want to see the object at full size you'll have to render it. Once it is rendered, you can see the bitmap preview of the object using the Bitmap Preview mode.

Refer to "Setting Up a Render" on page305 for more on rendering and "Display Modes" on page26 for more on Bitmap Preview mode

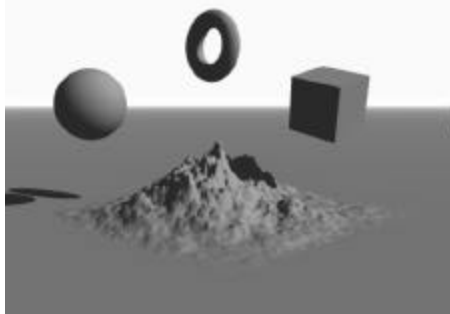

To see a full-sized preview of the object you'll need to render the scene.

CREATING BOOLEAN OBJECTS

A Boolean object is an object created by combining two or more objects to form a single object. Boolean objects are created by performing Boolean operations on a number of objects. You can perform three types of Boolean operations in Bryce: union, subtraction, and intersection.

Bryce uses Object properties to perform Boolean operations. Objects can be Neutral, Positive, Negative, or Intersecting. When you combine these objects in a group, the result is a Boolean object.

Boolean operations do not have any effect on Neutral objects. When you group a neutral object with a Boolean object, no Boolean operation is performed.

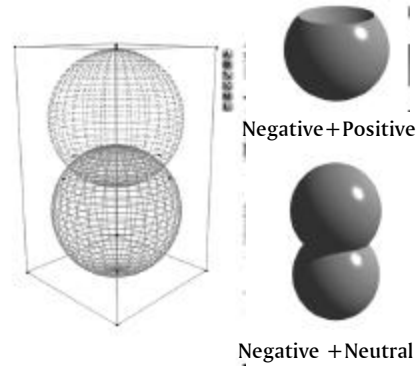

If you were to group a neutral object with a Boolean object, both objects would remain visible, as no Boolean operation occurs.

Objects are neutral by default.

If you are importing objects from Bryce 2, you may want to change some positive objects to neutral for faster rendering.

BOOLEAN OPERATIONS

Boolean Union is performed by grouping two positive objects. The area that is common to both objects is removed, creating a continuous object. For example, when you group two positive spheres, you get a kind of peanut shaped object which is the union of the two objects.

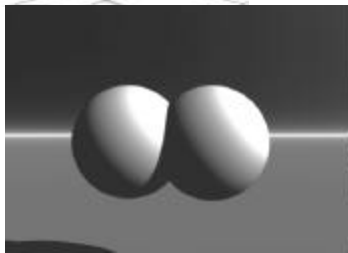
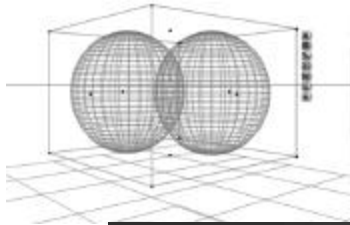

Boolean Union is performed by grouping two positive objects.

Boolean Subtraction is performed by grouping a negative object with a positive object. The area that is common to both objects is subtracted from the positive object, resulting in a positive object with negative space. For example, when you group a positive sphere with a negative one, the resulting object looks like a sphere with a crater.

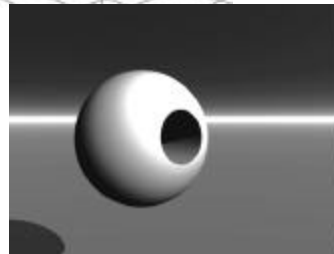
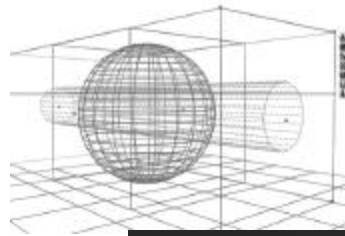

Boolean Subtraction is performed by grouping a positive object with a negative object.

Boolean Intersection is performed by combining an Intersecting object with a Positive object. The area that is common to both objects becomes the only visible portion of the group.

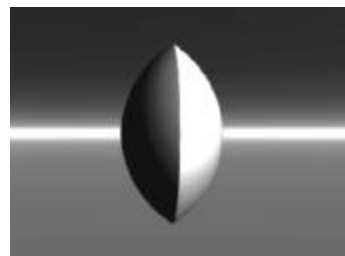
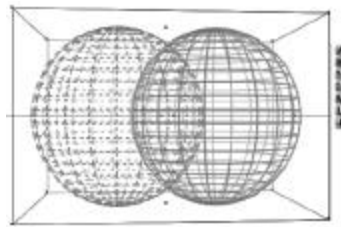

Boolean Intersection is performed by grouping a Positive object with an Intersecting object.

Negative or Intersecting objects must share space with at least one Positive object in the group to exhibit a Boolean operation. If there is no common space, Negative objects are invisible when rendered.

A group that contains an Intersecting object that does not intersect with any other object in the group becomes entirely invisible; this is because the Intersecting object is intersecting with nothing.

You can build very complex objects by compounding Booleans. Suppose you wanted to create a flute. You would first create the hollow tube by combining a positive cylinder with a negative cylinder, then create several negative spheres and group those with the tube, creating a simple flute.



This simple flute was created by grouping a hollow tube with several negative spheres.

By compounding more Boolean operations on top of this simple flute, you could create even more complex objects.

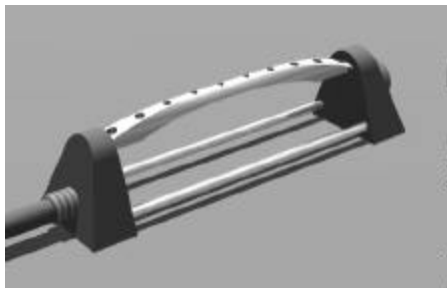

This sprinkler was created using compound Boolean operations.

Since Bryce performs Boolean operations using object attributes, you can adjust the shape of a Boolean object by repositioning the objects in the group. You can edit objects within groups using the Solo mode in the Selection palette. Refer to “Selecting Objects” on page 65 for more information.

The final Boolean object appears only in the rendered image or in the Nano-Preview. You won't be able to see the Boolean object in the Wireframe preview.

To SUBTRACT ONE OBJECT FROM ANOTHER:

- 1 Select an object.
- 2 Click the Abutton next to the object's bounding box, or press Command-Option-E/ Ctrl+Alt+E, or choose Objects menu > Edit Attributes.
The Object Attributes dialog appears.
- 3 Enable the Negative checkbox.
- 4 Move the negative object so that it intersects another object.
- 5 Make sure that the second object's Boolean attribute is set to Positive.
- 6 Select both objects and click the Gbutton next to the selection's bounding box to group them.

When your scene is rendered, the area where the two objects intersect is removed from the positive object.

To CREATE AN OBJECT THAT IS THE INTERSECTION OF TWO OBJECTS:

- 1 Select an object.
- 2 Click the Abutton next to the object's bounding box, or press Command-Option-E/ Ctrl+Alt+E, or choose Objects menu > Edit Attributes.
The Object Attributes dialog appears.
- 3 Enable the Intersecting checkbox.

- 4 Move the intersecting object so that it intersects another object.
- 5 Make sure that the second object's Boolean attribute is set to Positive.
- 6 Select both objects and click the Gbutton next to the selection's bounding box.

When your scene is rendered, the area where the two objects intersect becomes the only visible portion of the group.

USING THE PRESETS OBJECT LIBRARY

The Presets Object Library contains all the preset objects distributed with Bryce as well as presets you add. Objects in the library are either 3Dmodels or geometric paths. Refer to "Creating Geometric Paths" on page88 for more on geometric paths.

You can place objects from the library anywhere in your scene and edit them just as you would any object.

TO ADD AN OBJECT FROM THE PRESETS OBJECT LIBRARY TO YOUR SCENE:

- 1 Click the Triangle icon next to the Create button at the top of the Bryce environment. The Presets Object Library appears.
- 2 Click on the name of a category (to the left of the thumbnails).
- 3 Click on the preset thumbnails to view preset names and descriptions.
- 4 Click OK to add the selected object to your scene.

The Create palette does not need to be active for you to access the Presets Object Library.

ADDING AND DELETING PRESET OBJECTS

You can add preset objects to categories in the presets library. The presets library retains all Boolean, grouping and textural properties of the objects placed within it.

TO ADD AN OBJECT TO THE PRESET LIBRARY:

- 1 Select the object you want to add to the library.
- 2 Click the Triangle icon next to the Create button at the top of the Bryce window. The selected object appears in the preview area of the Presets Object Library dialog.
- 3 Click a category name. The library switches to the category you selected.
The new preset will be added to the category you select.
- 4 Click the Triangle icon in the bottom-right corner of the object preview and choose a view option from the menu.
Normal is the default view of your selected object.
Up Close displays a close-up of your object.
Render With Neutral Sky displays your object with a flat sky, instead of the sky applied to your scene.
- 5 Set up the preview of the object:
 - Drag the preview area to rotate the view of the object.
 - Hold down the spacebar and drag up, down, right, or left to pan the object preview.
 - Hold down Command/Ctrl and drag in the preview area to zoom in and out of the preview.
- 6 Click the Add button at the bottom of the dialog. The Add Object dialog appears.
- 7 Enter a name for the new preset in the Preset Name field.

- 8 Enter a description of the preset in the Description field and click the OK icon.
This name and description will appear beneath the object preview whenever the preset is selected.
- 9 Click the OK icon. Your preset is added to the first available space within the current category.

To delete an object preset:

- 1 Click the Triangle icon next to the Create button at the top of the Bryce environment. The Presets Object Library appears.
- 2 Click on the preset you want to delete, or hold down Shift and select a continuous series of presets, or hold down Command/Ctrl and select a discontinuous set of presets.
- 3 Click the Delete button at the bottom of the dialog.

IMPORTING AND EXPORTING PRESET OBJECTS

Importing and exporting presets is a handy way to exchange custom presets with other users.

To import a preset object file:

- 1 Click the Triangle icon next to the Create button at the top of the Bryce window. The Presets Object Library appears.
- 2 Select the category into which you want to import the file.
- 3 Click the Import button at the bottom of the dialog. The file open dialog appears.
- 4 Locate the file that you would like to import and click Import.
The contents of the file are placed into the first available space in the current category.

To export a preset object file:

- 1 Click the Triangle icon next to the Create button at the top of the Bryce window. The Preset Objects Library appears.

- 2 Select the category from which you want to export presets.
- 3 Select the preset or presets you wish to export.
- 4 Click the Export button at the bottom of the dialog. The save file dialog appears.
- 5 Enter a name and location for the file and click Save.

ADDING AND DELETING PRESET FOLDERS AND CATEGORIES

Bryce comes with two preset category folders: Installed and User. The Installed preset category folder contains the presets that are installed with Bryce. The User preset category folder is empty by default. Each preset category folder can contain up to 14 preset categories. Each preset category can contain a virtually unlimited number of presets. You can create additional preset category folders and preset categories to suit your needs.

To choose a preset category folder:

- Click the triangle icon next to the preset category folder name at the bottom left of the Preset Object Library and choose a preset category folder from the drop-down menu.
The Preset Object Library opens that preset category folder and displays the categories and presets found in that folder.

To add a preset category folder to the Preset Objects Library:

- 1 Navigate to the folder where Bryce 5 is installed.
- 2 Open the Presets folder.
- 3 Open the Objects folder.

To add a preset category folder to the Preset Textures Library, open the Textures folder. To add a preset category folder to the Preset Materials Library, open the Materials folder.

- 4 Create a new folder and give it a name. The folder name will appear in the preset category folders drop-down menu.

Preset folder names are limited to 8 characters.

To delete a preset category folder:

- 1 Navigate to the folder where Bryce 5 is installed.
- 2 Open the Presets folder.
- 3 Open the Objects folder.

To delete a preset category folder to the Preset Textures Library, open the Textures folder. To delete a preset category folder to the Preset Materials Library, open the Materials folder.

- 4 Delete the preset category folder. The preset category folder and all the preset categories and presets it contains will be deleted.

To add a preset category to a preset category folder in the Preset Objects Library:

- 1 Select a category in the Preset Objects Library.

To add a preset category to the Preset Textures Library, select a category in the Preset Textures Library. To add a preset category to the Preset Materials Library, select a category in the Preset Materials Library.

- 2 Select a preset object.
- 3 Click the Export button at the bottom of the dialog. The save file dialog appears.
- 4 Choose the preset category folder you want to add categories to as your save location.
- 5 Enter a name for the new preset category and click Save.

The new preset category will appear in the preset category folder you selected. It will contain the object you selected before exporting. You can delete that object from the preset category and add or import your own objects.

CREATING INFINITE PLANES

An infinite plane object extends in all directions to infinity. When you create a plane in Bryce it appears as a finite plane to make it easier to position, but when your scene is rendered the plane extends infinitely in all directions.

Though procedurally these three infinite planes are different, they are all considered to be Infinite Planes for the purpose of selecting with the Selection tools.

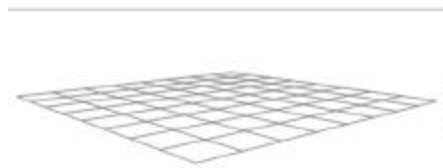

When you add a plane object it appears as a finite object in the Working window...

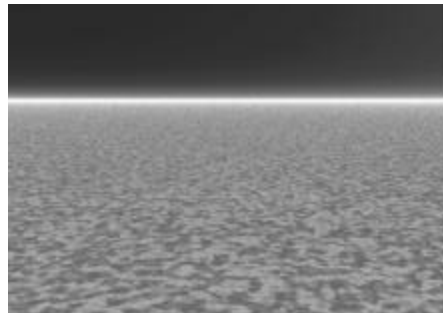

...but when you render the scene it extends to infinity.

GROUND

Ground planes are created at ground level. By default, all new scenes open with an infinite ground plane.

To create a Ground plane:

- Click the Ground plane tool.

Once the plane appears in your scene you can edit it like any other object.

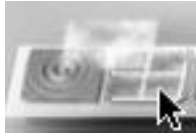

Use the Ground plane to add ground to your environment.

The Ground plane is created with a gray color, as are all Bryce primitives. Once you begin assigning textures to objects, Ground objects (as well as all other primitive objects) will inherit the texture assigned to the previous object.

WATER

Water planes are created just a bit higher than ground level. That way, if you have already created ground and terrains, you can easily place a water plane into your scene and immediately see the terrains peeking out from the water.

TO CREATE A WATER PLANE:

- Click the Water plane tool.

Once the plane appears in your scene you can edit it like any other object. Refer to “Editing Object Attributes” on page 230 for more on editing objects.



Use the Water plane to add bodies of water to your environment.

Water planes are created with a water texture randomly chosen from the Waters&Liquids Preset Materials Library. You can change this material by selecting a different preset or creating a new material.

TO CHANGE THE WATER PLANE’S PRESET MATERIAL:

- 1 Click the second Triangle icon at the top of the Bryce environment. The Preset Materials Library appears.
- 2 Choose a library and material, then click the OK icon.

Refer to “Using the Materials Presets Library” on page 164 for more on the Preset Materials Library.

Cloud

Cloud planes are placed much higher in your scene, since they’re generally the highest objects in your environment.

TO CREATE A CLOUD PLANE:

- Click the Cloud plane tool.

Once the plane appears in your scene you can edit it like any other object.



Use the Cloud plane to add clouds to your environment.

Cloud planes are automatically assigned a randomly chosen texture from the Clouds&Fogs Preset Materials Library. You can change this material by selecting a different preset or creating a new material.

TO CHANGE THE CLOUD PLANE’S PRESET MATERIAL:

- 1 Click the second Triangle icon at the top of the Bryce environment. The Preset Materials Library appears.
- 2 Choose a library and material, then click the OK icon.

INFINITE SLABS

An infinite plane is a plane object that has no depth. An infinite slab is a plane object that has depth. The plane has no effect on objects above it or below it; an infinite slab can affect objects within it.

For example, anything you place within the slab's depth will be affected by the slab's volume color.

Slabs are usually used to create water. When you create a water slab, you create water with realistic volume. This means that if you sink an object into the water it will be affected by the colors or textures you assign to the slab's volume.

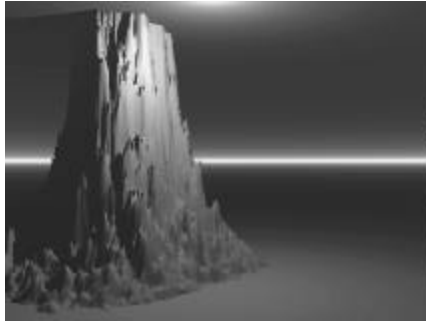

In an infinite slab, the plane in the scene has depth that affects the objects within it.

The realistic look of a water slab depends almost entirely on the material you assign to it. The Volume color plays an essential role in creating realistic water effects. Refer to “Volume Color” on page 142 for more on Volume Color and materials.

TO CREATE AN INFINITE SLAB:

- 1 Click the plane tool and choose the Volume option from the popup.
- 2 Select the slab.
- 3 Click the Aicon that appears next to its bounding box. The Object Attributes dialog appears.
- 4 Enter a depth value in the Size Y field and click the OK icon.

CREATING TERRAINS

Terrain objects define the landscape of your scene. They represent the land forms of any scene: mountains, deserts, islands, or even floating cities. In Bryce, a terrain object is a height map that determines the shape of your landscape.

Bryce creates a terrain's shape by converting brightness values in grayscale images into a height map. White areas in the image result in the highest altitudes and black areas result in the lowest. The Terrain Editor lets you generate the grayscale images that are used to create terrain objects.

To add a terrain object to your scene:

- Click the terrain object tool. A randomly generated terrain appears in your scene.

Once you have a terrain object you can customize it in the Terrain Editor. Refer to “Editing Terrains” on page 91 for more on editing terrains.

CREATING TREES

The tree object tool creates natural-looking tree shapes that can be assigned materials, shaped, and positioned throughout your scene.

TO ADD A TREE OBJECT TO YOUR SCENE:

- Click the tree object tool. The default tree appears in your scene.

Once you have a tree object, you can customize it in the Tree Lab. You can control the size and texture of the tree trunk, the thickness and number of branches, and the type of foliage and its frequency, randomness, and color. You can import images to be used for the trunk or foliage texture. You can also control how gravity affects the tree, making branches bend and leaves droop to varying degrees. Refer to “Editing Trees” on page 119 for more on using the Tree Lab.

CREATING STONES

The Stone object tool creates random, natural-looking Stone shapes that can be assigned materials and positioned throughout your scene.

TO CREATE A STONE OBJECT:

- Click the Stone object tool.

Stones objects are mesh based, and can be smoothed or unsmoothed using the Select Mesh dialog. Refer to “Editing Imported Meshes and Stones” on page238 for more information.

Stones are assigned random textures automatically from the Rocks&Stones Preset Materials Library.

TO CHANGE A STONE’S PRESET MATERIAL:

- 1 Click the second Triangle icon at the top of the Bryce environment. The Preset Materials Library appears.
- 2 Choose a library and material, then click the OK icon.

Since Stones are essentially clumps of meshes, their realism is highly dependent on the textures assigned to them. For example, if you assign a flat texture with no bumpiness to a Stone, the results won’t be very Stone-like. Try to assign rocky textures to stones. Refer to “Using the Material Preview Area” on page163 for more on assigning textures.

CREATING SYMMETRICAL LATTICES

A Symmetrical Lattice is a terrain object that has a mirror image of itself fused at its base. When you modify one half of the lattice, the corresponding changes are applied to the mirrored half.

The Symmetrical Lattice can be a great timesaving tool. Instead of creating symmetrical shapes by duplicating and aligning two halves, you just need to create one half of a lattice and your object is

duplicated for you. Symmetrical Lattices are edited as Terrains, using the Terrain Editor. Refer to “Clipping Terrains” on page114 for more information.

Many advanced types of objects can be created using the symmetrical lattice object. Any object that’s symmetrical can be created by painting it’s shape in the Terrain Editor.



The hair dryer in this example was created using a symmetrical lattice object.

TO CREATE A SYMMETRICAL LATTICE:

- Click the Symmetrical Lattice tool.

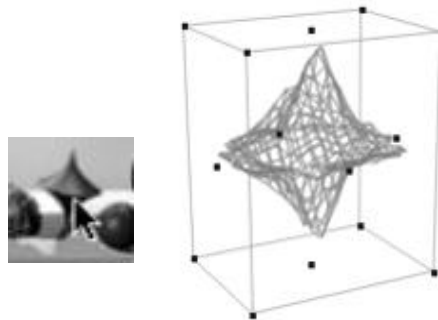

Use the Symmetrical Lattice tool to create symmetrical objects.

CREATING METABALLS

Also new to Bryce are Metaballs, a new object type found on the Create palette. Metaballs are spheres that blend into each other based on proximity. With Metaballs, you can create a wide variety of realistic-looking shapes.

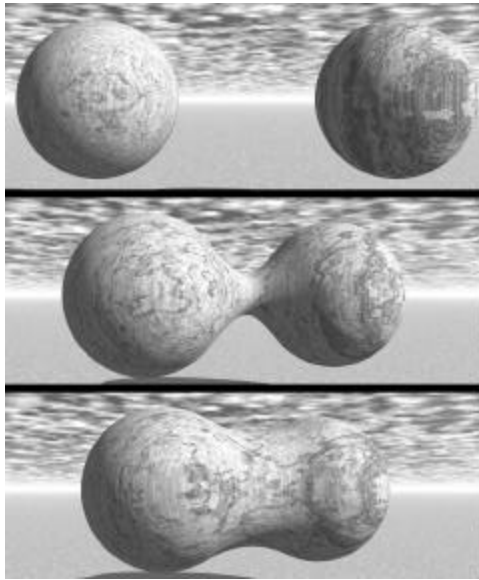

Metaballs are spheres that blend into each other based on proximity.

Metaballs let you quickly create fluid shapes that are otherwise time-consuming or even impossible to create using primitives and Boolean operations.

When you are in Wireframe view, Metaballs are represented as simple spheres. To see how the Metaballs will blend together, you must either look at the Nano-preview or render the image.

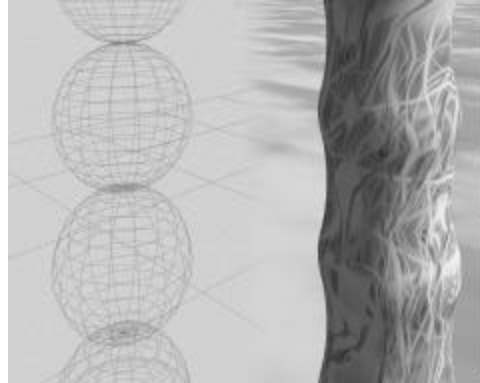

Metaballs appear as distinct spheres in Wireframe view and are blended together when rendered.

You can blend Metaballs of different sizes. This gives you more control over the resulting shape. To blend Metaballs, simply place the Metaballs close to each other. The closer together they are, the more they will blend into each other. The farther apart they are, the more they will resemble distinct spheres.

You can also change the shape of Metaballs in your scene to get different effects. For example, you can squash or stretch a Metaball, changing the surface area that blends into nearby Metaballs. Two oval Metaballs will give you a different blend result than two spherical Metaballs.

For Metaballs to blend smoothly, they must have the same material. If you blend two Metaballs with of differing materials, you will not get a smoothly blended result.

CREATING A PICT OBJECT

A Pict Object is a 2D picture that is applied to a 2D finite plane. The object is basically a picture on a frame. The Frame is a 2D plane, meaning that it has no depth. If you view it from the side, it disappears.

Using a Pict Object is a quick way of creating very complex-looking objects. The only limitation is that you can view them from only one angle, so the front of the Pict Object must always be facing the camera.

The Alpha channel of the object can be used to create transparencies in the Pict Object.



This object was created using a 2D Pict Object....



however, if you move the camera, the 2D nature of the object is very obvious.

A good way of ensuring that your 2D Pict Object never appears distorted is to have it track the camera. Refer to “Tracking Objects” on page 344 for more on tracking.

ALPHA CHANNELS AND PICT OBJECTS

The picture you use as a Pict Object must have an Alpha channel. Refer to “Alpha Channels” on page 84 for more on Alpha channels.

The alpha channel of your Pict images will allow you to specify visible and invisible portions of your picture texture.

For example, you can clip out a picture’s background so that only the main object in the picture is visible.



This is what the car image looks like with and without an alpha channel applied.

The shadow cast by the image will be in the shape of the picture’s alpha channel, which gives a more realistic look.

TO CREATE A PICT OBJECT:

- 1 Click the Pict Object tool or any empty square to open up the Pictures dialog.

The Pictures dialog appears.

- 2 Click an image square to load an image.
- 3 If the image you want is not in the library:
 - Click the Combination Load button. The load image dialog appears.
 - Use the dialog controls to locate the picture you want to use and click Open.

or

- In another application, copy the picture you want to use to the clipboard.
- Access the Pictures dialog and click the Paste button.

The picture is loaded into the first image box and its alpha channels are loaded into the second box.



When you load a new picture into the Pictures dialog, the main image is loaded into the first box, its alpha channel is loaded into the second box, and the combination is loaded into the third.

You can invert the alpha channel by clicking the invert button



- 4 Click the OK icon to exit the dialog.
Bryce creates a 2D plane and maps the image onto it as a texture. The Pict Object is created with the same aspect ratio as the original picture.

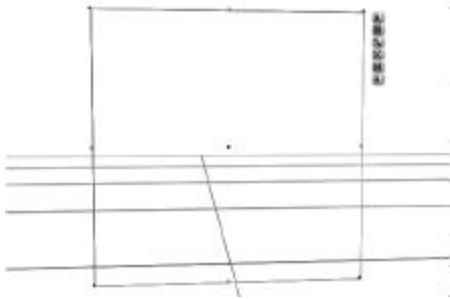

When you exit the picture dialog, the image is mapped onto a 2D plane and placed in your scene.

WORKING WITH PICTURES

Pictures can be used in several ways in Bryce. They can be used as 2D Pict Objects or as components in materials or gels.

When you use a picture as an object, it is applied to a 2D plane and appears as an object in the Working window. Refer to "Creating a Pict Object" on page 81 for more on creating 2D Pict Objects.

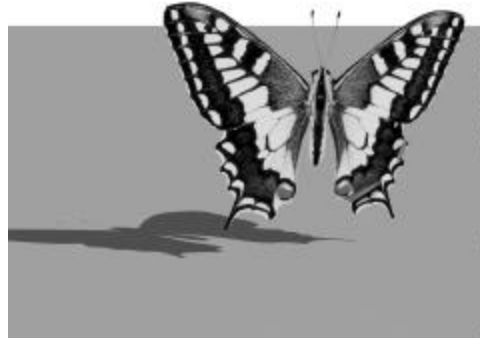

This is what a picture looks like when it is used as an object.

When you use a picture as a material component, the image is applied to a material channel, where its values are used to drive the value of the channel. Refer to "Applying Materials" on page 127 for more on working with Materials.



This is what a picture looks like when it is used as part of a material.

When you use a picture as a gel, the image is placed in front of the light and appears as a projection. Refer to "Applying Gels" on page 284 for more on gels.

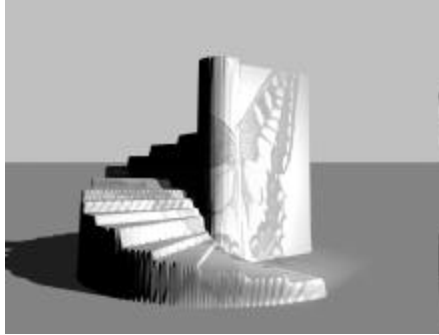

This is what a picture looks like when it is used as a gel.

Alpha Channels

Every image contains a number of channels that store data about the makeup of the picture. For instance, channels can contain masks, colors, or bump information.

The alpha channel of an image is its first channel. The channel is like a grayscale map that accompanies an image that is used primarily as a “mask.” Areas in the alpha channel that are black (appearing transparent) are ignored by the Bryce as it computes the picture. Bryce recognizes and computes areas that are white (appearing opaque).

The most common use for alpha channels is to mask the contours of a 2D object, separating it from any unwanted background information. For instance, you may import a picture of a dog. If you have created an alpha channel “mask” describing the area of the dog as white and the “non-dog” area as black, then unwanted cats and mail carriers in the original picture’s background will not be seen in your rendered image.



Without Mask



With Mask

This example illustrates how the Alpha channel mask is used to eliminate the unwanted areas of an image.

In Bryce, Alpha channels are also used when your picture is a component in a material. In this case the alpha channel can be used to determine everything from the bumps in a material to how a surface property is applied on an object. Refer to “2D Textures” on page 146 for more on using pictures in a material.

If you want to use the picture in the library for multiple purposes, you’ll need to make sure that all the pictures have an alpha channel.

The Picture Library

The Picture Library stores all the images available in Bryce and can be used to catalog pictures. You can store and import any number of pictures in the library that your system memory and disk space will allow.

There are two ways of accessing the Picture Library. The method you use depends on how you're going to use the image.

TO ACCESS THE PICTURE LIBRARY FROM THE CREATE PALETTE:

- Click the Pict Object tool. The library automatically opens.

TO ACCESS THE PICTURE LIBRARY FROM THE MATERIALS LAB:

- 1 Select an object.
- 2 Click the Micon that appears next to the object's bounding box. The Materials Lab appears.
- 3 Click on one of the columns in the grid to activate a component window.
- 4 In the window, click the Pbutton in the bottom-left corner. A default picture appears in the window.
- 5 Click the Pink button at the top of the window. The Picture Library appears.

TO ACCESS THE PICTURE LIBRARY FROM THE LIGHT EDITOR:

- 1 Select a light source.
- 2 Click the Eicon that appears next to the object's bounding box. The Light Editor appears.
- 3 Click the 2D Texture button at the bottom of the editor. The library appears.

PREVIEWING PICTURES

The three most prominent items at the top of the library are the RGB Image, Alpha, and Combined preview windows. The first window displays the current picture, the second window displays the alpha channel associated with the picture, and the third displays the resulting picture after the alpha channel is combined with the picture.

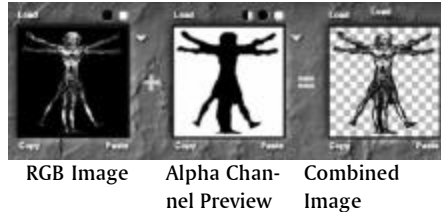

The three windows at the top of the editor display the RGB Image, its alpha channel, and the result of combining the two.

PICTURE THUMBNAILS

Below the three preview windows are the picture thumbnails that display a small preview of each picture in the library. The gray thumbnails represent empty slots in the library. When you load images, they are added to the first available gray slot.



The thumbnails below the preview windows represent all the pictures available in the library.

If there are a large number of pictures in the library, you can use the scroll bar to scroll through all the thumbnails.

TO DISPLAY AN IMAGE IN THE LIBRARY:

- Click on the picture's thumbnail. The picture and its associated alpha channel appear in the three preview windows at the top of the dialog.

LOADING PICTURES INTO THE LIBRARY

You can load pictures into the library to create your own custom library. Pictures can be loaded into any of the three preview windows. If you want to add a new picture to the library, you need to load it into the last preview window, the Combined Image window.

When you load a picture into the first window, you're loading only the picture's RGB (Red, Green, and Blue) color information.

The picture loaded into the first preview window replaces the currently selected picture in the library, so you're replacing a picture in the library with the picture you're loading.

When you load a picture into the second window, you're loading only the picture's alpha channel.

The alpha channel determines which portions of the picture are visible. The areas of the picture that are transparent appear as a checkerboard pattern.

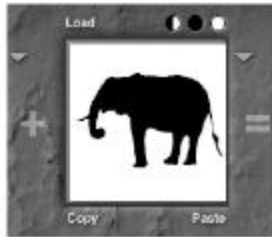

When you load an image into the Alpha Channel window, the black and white alpha channel appears in the window.

Every picture should have an alpha channel assigned to it. If the picture does not have an alpha channel, the resulting image appears completely white.

If your picture doesn't have an alpha channel, you can copy the image from the RGB Image window into the Alpha Channel window. This way your picture won't appear completely opaque.

The Alpha channel you load does not have to necessarily match the image. You can create some interesting clipping effects by combining different alpha channels and images.



In this example, the image was combined with a different alpha channel to create a new clipping effect.

To REPLACE THE RGB INFORMATION IN A PICTURE:

- 1 Click the thumbnail of the picture you want to replace.
- 2 Click the Load button on top of the RGB Image window. The Load dialog appears.
- 3 Use the dialog controls to locate the desired image and click Load.

The picture appears in the first preview window.

To REPLACE THE ALPHA CHANNEL INFORMATION IN A PICTURE:

- 1 Click the thumbnail of the picture you want to replace.
- 2 Click the Load button on top of the Alpha Channel window. The Load dialog appears.
- 3 Use the dialog controls to locate the desired image and click Load.

The picture's alpha channel appears in the first preview window.

To LOAD A NEW PICTURE INTO THE LIBRARY:

- 1 Click the picture slot in the bottom of the library where you want to load the new picture.

The Load dialog appears.

- 2 Use the dialog controls to locate the desired image and click Load.

The picture's thumbnail appears in the picture slot.

COPYING AND PASTING PICTURES

Copying and pasting in the Picture Library works differently for each of the three image windows.

When you copy and paste into the first window, you're pasting only RGB color information, so if you copy an image from the Combined window, only the color information is pasted into the RGB window.

As with loading, any changes you make in the RGB Image window affects the selected image.

When you copy and paste into the second window, you're working with only the Alpha Channel information, so any image you paste into this window will appear as an alpha channel image (that is, black and white). Any changes you make in this window affect only the selected image.

When you copy an image from the Combined window the entire image is placed on the clipboard. Depending on where you paste it, only a portion of the image may be used.

When you paste a picture into the Combined window, it appears as a color image with transparent and solid areas. All pictures are treated as color. So if you paste a picture copied from the Alpha Channel window in this window, you'll get an RGB representation of the alpha channel image. As well, any image pasted into this window creates a new picture entry in the library.

To copy and paste RGB information in a picture:

- 1 Click the Copy button below the RGB Image window.
- 2 Click the Paste button below the window where you want the RGB image to appear.
 - If you paste the image into the Alpha Channel window, it is desaturated and used as an alpha channel.
 - If you paste it into the Combined Image window, the RGB image becomes a new entry in the library.

To copy and paste Alpha Channel information in a picture:

- 1 Click the Copy button below the Alpha Channel window.
- 2 Click the Paste button below the window where you want the Alpha Channel information to appear.

- If you paste the image into the RGB Image window, an RGB representation of the alpha channel is placed in the window.
- If you paste it into the Combined Image window, an RGB representation of the alpha channel is placed in an empty slot in the library.

To create a new picture using RGB color information only:

- 1 Click the Copy button below the RGB Image window.
- 2 Click the Paste button below the Combined window. The RGB information is placed in an empty slot in the library.

To create a new picture using Alpha channel information only:

- 1 Click the Copy button below the Alpha Channel window.
- 2 Click the Paste button below the Combined window. The alpha channel information is placed in an empty slot in the library.

Deleting Pictures

When you delete a picture, you remove all the image information (including color and alpha channel) from the library.

To delete a picture from the library:

- 1 Click the thumbnail for the picture you want to delete.
- 2 Click the Delete Pict button.

To delete all pictures from the library:

- Click Delete All.

INVERTING THE ALPHA CHANNEL

When you invert an alpha channel all the black areas become white and the white areas become black. This means that all the areas that were transparent now become solid and vice versa.

TO INVERT AN ALPHA CHANNEL:

- Click the Invert button above the Alpha channel window.



The Invert button swaps all the black and white values in the alpha channel.

PICTURE LISTS

A Picture List is a file that contains a group of pictures. A Picture list can be used to store all the pictures used in a given scene, or to store a series of pictures you use most often.

You should also use a picture list to store any pictures you've used as part of a material.

There are several Pict texture List files provided as samples for your first excursions.

TO OPEN A PICTURE LIST:

- 1 Click the Open List button at the bottom of the Picture Library. The Open dialog appears.
- 2 Use the dialog controls to locate the desired list and click Open. The pictures in the list appear in the library.

TO SAVE A PICTURE LIST:

- 1 Click the Save List button at the bottom of the Picture Library. The Save dialog appears.
- 2 Enter a name for the list and click Save.

Name the list the same as the scene. This way, you can easily find the list that belongs to a specific scene.

CREATING GEOMETRIC PATHS

A geometric path is an object that acts as a motion path for other objects. Geometric Paths do not render as objects.

You can think of these paths as railroad tracks. Objects can move along the track but they can't move off of it.



Objects attached to a geometric path can move to any point along the path, but they can't move off it. So their trajectory is controlled by the shape of the path.

You can control how an object is constrained to the path using the options in the Object Attributes dialog.

Geometric paths can be edited just as you would any other object. You rotate, position, or scale the path using the tools in the Edit palette. You can also edit a path by dragging its control points. This way you can change the geometry of the paths as well as the trajectory of any object attached to it.

Geometric paths are especially useful when you are creating motion animations, as they can help you create predictable and repeatable motion.

The other great thing about geometric paths is that you can have more than one object attached to it. This can be very useful if you want a number of objects to move along the same trajectory.



You can attach multiple objects to the same path. The motion of each object on the path is constrained by the shape of the path.

Objects that are attached to the same path can be animated at different rates. So, if you can think of the objects as different trains on the same track, some trains are at the beginning of the track, others are in the middle, and some are at the end. All the object attached to the path will have the same trajectory.

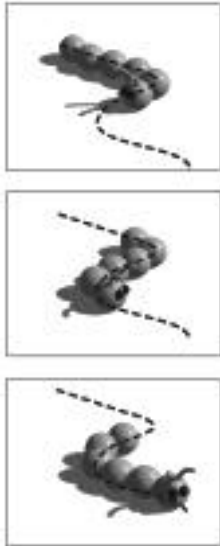

All the objects attached to a path have the same trajectory, but they can move at different rates.

For example, this caterpillar is made up cylinders all attached to the same path, but they're moving at different rates, so it looks as though the body is slithering.

You can also align objects differently to the same path. So object may appear to tilt differently as they follow the same trajectory.

Since geometric paths are objects, they can also be attached to other paths. Some very complex types of motion can be created using this technique.



For example, you can simulate the motion of the solar system by attaching an object on a circular path to a circular geometric

path. The object on the circular path would act like a moon orbiting a planet which is also orbiting the Sun.

To CREATE A GEOMETRIC PATH:

- Choose Objects menu > Create Path.
A default-shaped path object appears in your scene.

To CONVERT A MOTION PATH INTO A GEOMETRIC PATH OBJECT:

- 1 Select an object with a motion path.
- 2 Choose Objects menu > Create Path.
A path object with the same shape as the path you selected is created.

To LINK AN OBJECT TO A PATH:

- 1 Select the object you want to attach to the path.
- 2 Move the cursor over the Link icon that appears next to its bounding box.
- 3 Drag the linking control handle from the object to the path object.

IMPORTING OBJECTS

Bryce can open many different file formats, including files created in previous versions of Bryce. For instructions on importing files as well as a list of all import formats, see "Using Bryce with Other Applications" on page 363.

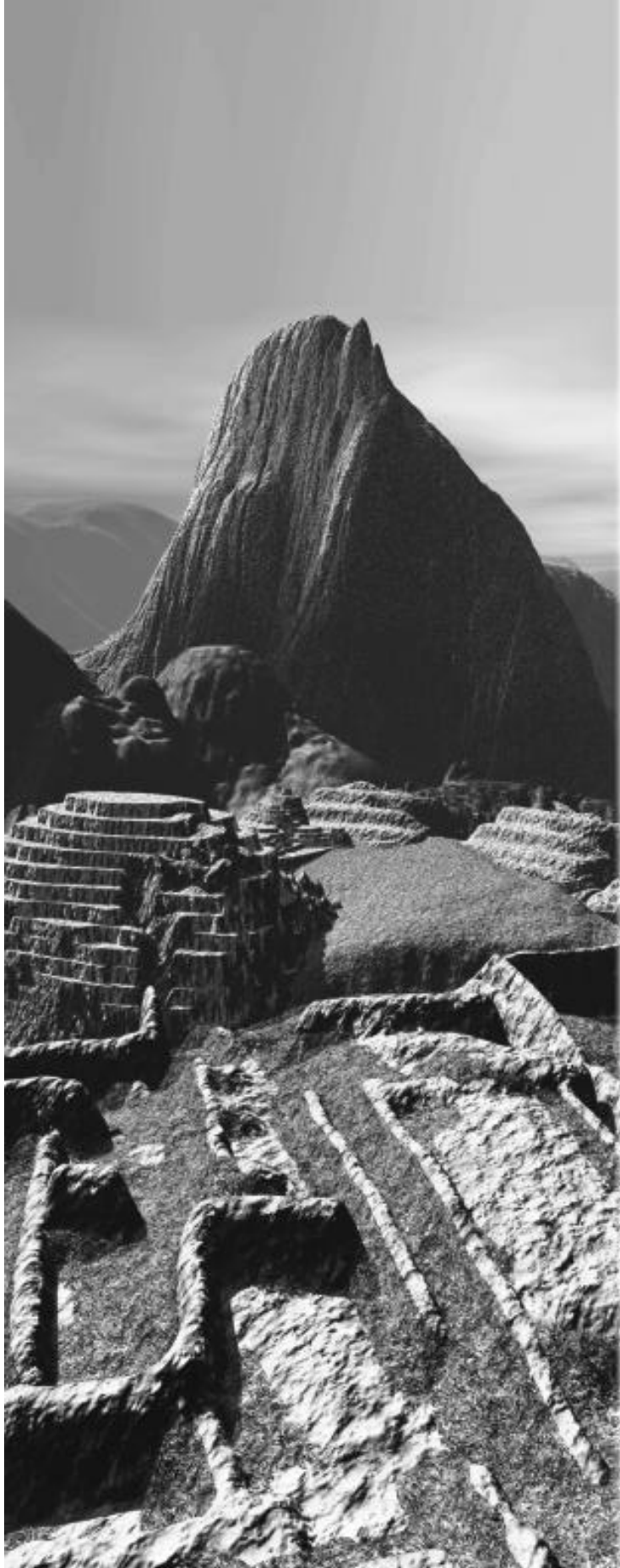

5

EDITING TERRAINS

The Terrain Editor can be used to generate a grayscale image that is converted into a terrain object. It can also be used to edit an existing terrain.

Creating terrains in the Terrain Editor is a two-step process. First, generate the source of your terrain image by using the preset effects, painting an image using the paintbrush, or importing a picture. Then, use the Terrain Editor's filtering tools to fine-tune the grayscale values in your terrain.

To access the Terrain Editor, you must have a terrain object in your scene. When the Terrain Editor opens, it temporarily replaces the screen and displays the current terrain in a two-dimensional preview and a three-dimensional preview. The height map that was used to create the terrain is displayed in the Terrain Canvas.

You can also animate the creation of a terrain. Using the Animation controls available at the bottom of the editor, you can change the shape of your terrain object over time.

CREATING TERRAINS

You can create terrains in several ways. You can let the editor do all the work of generating a terrain based on a series of algorithms, you can use the editor's painting tools to create a custom image, or you can import an image into the editor.

When you generate a terrain, you use the Terrain Editor's Elevation tools, which include dozens of effects optimized for the purpose of heightening realism in Bryce terrains.

When you paint a terrain you use the editor's grayscale paintbrush to paint a topographical image. The image is then converted to a terrain object.

You can also create a terrain by importing a picture into the editor. The picture is converted to grayscale and used to generate altitude values.

CREATING LANDSCAPES

When you're planning the shape of your terrain, keep in mind the kind of landscape you want to create. You don't have to create all the land in your scene as a single terrain. You can create complex landscapes by combining several terrain objects.

Before creating terrain objects, plan out the entire map of your landscape. Then you'll be able to see where different terrain objects might be combined to create a single land mass.

If you have more terrains in your scene, you'll have a bigger scale for the environment. This gives you more resolution and a more realistic-looking effect.



Before you start creating terrains you should map out all the land masses in your environment...



...then you'll be able to see where you will need to combine more than one terrain to create a specific type of landscape.

Pay attention to where the camera is positioned in the scene. Terrains that are closer to the camera need to be more detailed than those off in the distance.

ANIMATION AND TERRAIN EDITING

You can record the process of creating a terrain into an animation using the Animation controls. Refer to "Animating" on page 319 for more on animating terrains. Some of the Elevation tools can produce unpredictable results when they're animated, so you may want to experiment with animating elevations before you create your final terrain.

THE TERRAIN EDITOR WORKSPACE

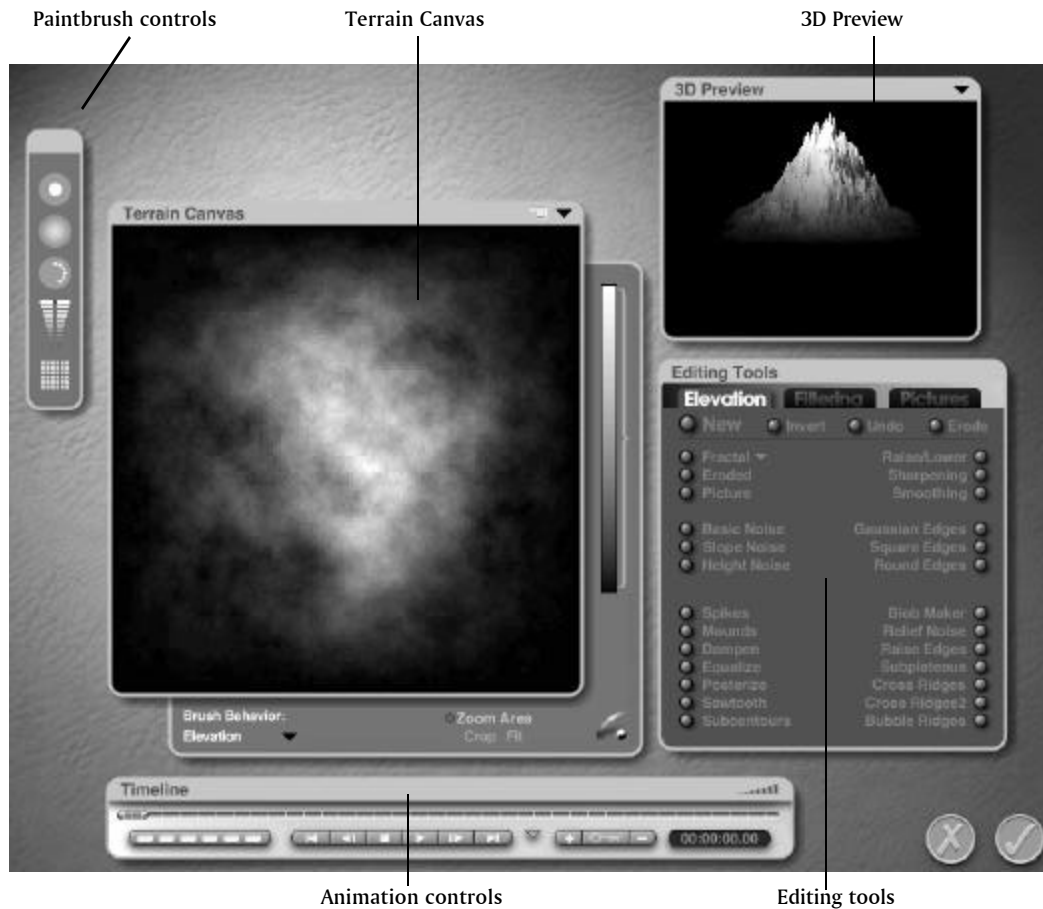

FEATURES OF THE TERRAIN EDITOR

The Terrain Editor is divided into five sections:

- Terrain Canvas — displays the grayscale image used as a height map
- 3D Preview — displays a three-dimensional preview of the terrain you're working on
- Paintbrush tools — let you adjust the paintbrush

- Animation controls — let you set up key frames for animating the terrain
- Editing tools — let you generate and edit the terrain's height map

To open the Terrain Editor:

- 1 Select a terrain object in your scene.
- 2 Click the E icon that appears next to the terrain object,

or choose Objects menu>Edit Object,

or click the Edit text button to open the Edit palette, and then click the Edit Terrain tool,

or press Command/Ctrl+E.



TERRAIN CANVAS

The Terrain Canvas displays the grayscale image that is used to create the terrain object. You can think of the Terrain Canvas as a top view of the terrain object you're creating. The Terrain Canvas is where you paint the height map for your terrain.

TO SET TERRAIN CANVAS OPTIONS:

- Click the triangle icon in the top right corner of the Terrain Canvas and choose an option from the menu:
 - Set Preview Size lets you change the size of the Terrain Canvas frame. You can choose from five preview sizes.
 - Visible Brush lets you turn the circle of the brush on and off.
 - Solid applies volumetric materials to the terrain. Even if you are not using volume materials, this selection causes the material to render as a solid.
 - Smooth allows a smooth rendering of the terrain. If this is not selected, the terrain is faceted.
 - Keep Gradient makes the gradient the terrain's diffuse color.
 - Export lets you save a terrain in a variety of file formats. You can then import a saved terrain into another 3D application or a different Bryce scene.

You can also access a number of tools in the Terrain Canvas, including the gradient strip, the bracket, controls for color mapping, the Zoom Area control, and the Brush Mode selector.

TO ACCESS A TOOL IN THE TERRAIN CANVAS:

- Click the menu icon at the top right of the Terrain Canvas. The Terrain Canvas tool area will open up.

The right side of the Terrain Canvas tool area contains a gradient strip and bracket for clipping operations. In the bottom right corner, you will find controls for color mapping. Refer to "Adding Color to Terrains" on page 113 and "Clipping Terrains" on page 114 for more on these tools.

Across the bottom of the Terrain Canvas tool area, you will find a Brush Mode selector and the Zoom Area controls. Refer to "Using the paintbrush" on page 106 and "Using the Zoom Area" on page 98 for more on these tools.

3D PREVIEW

The 3D Preview displays a terrain object based on the image in the Terrain Canvas. As you edit the terrain image, the preview updates to show the result of your changes.

The 3D Preview has several options that control how the preview updates and displays.

TO SET 3D PREVIEW OPTIONS:

- Click the triangle icon in the top right corner of the 3D Preview and choose an option from the menu:
 - Set Preview Size lets you change the size of the 3D Preview frame. You can choose from four preview sizes.
 - Flat Preview is the default preview type. In Flat Preview, you see a basic rendered preview of the terrain using a plain grayscale material with basic shading and lighting.

Rendered Preview displays a fully rendered view of the terrain, including any materials you have applied.

Auto Rotate sets the 3D Preview to rotate when it is in Flat Preview mode. The 3D Preview updates as it turns.

Realtime Linking connects all terrain editing to the 3D Preview. Every change you make is applied simultaneously to the Terrain Canvas and the 3D Preview.

RIP To Screen displays a full-screen preview of your terrain. Clicking anywhere will return you to the main Terrain Editor. Use Command/Ctrl+W to toggle in and out of this mode.

The preview of your terrain can be rotated so that you can see your terrain object from different angles.

TO ROTATE THE TERRAIN PREVIEW:

- Click and drag the preview object in the direction you want to rotate the terrain.

PAINTBRUSH CONTROLS

Although you can create some very spectacular terrains using just the elevation tools, there are times when you want to create a precise Terrain Canvas. The Terrain Editor's Paintbrush lets you paint any type of terrain you wish. Using the Paintbrush, you can re-create real-world topographical maps or design landscapes with specific contours.

The Paintbrush controls let you select the size, hardness, flow, and level of the Paintbrush, as well as control the resolution of the grayscale data.

PAINTBRUSH SIZE

The Paintbrush size control lets you select the size of the Paintbrush.



TO CHANGE THE PAINTBRUSH SIZE:

- Drag left or right over the Paintbrush size control. Dragging towards the center decreases the Paintbrush size while dragging away from the center increases the Paintbrush size.

PAINTBRUSH HARDNESS

The Paintbrush hardness control lets you choose how hard to make the edges of the Paintbrush. A hard Paintbrush has sharp edges and will create a very vertical effect such as a cliff edge. A soft Paintbrush has feathered edges and will blend more with the existing terrain, providing a more gently sloping effect.



TO CHANGE THE PAINTBRUSH HARDNESS:

- Drag left or right over the Paintbrush hardness control. Dragging towards the center increases the hardness of the Paintbrush, while dragging away from the center makes the Paintbrush softer.

PAINTBRUSH FLOW

The Paintbrush flow control lets you set the density of the grayscale value being applied by the Paintbrush.



TO CHANGE THE PAINTBRUSH FLOW:

- Drag left or right over the Paintbrush flow control. Dragging left decreases the flow, while dragging right increases the flow.

PAINTBRUSH LEVEL

The Paintbrush level control lets you set the grayscale value of the Paintbrush. Darker values produce lower terrain while lighter values produce higher terrains.



TO CHANGE THE PAINTBRUSH LEVEL:

- Drag up or down over the Paintbrush level control. A small red dot in the middle of the control indicates the current level.

GRID SELECTOR

The grid selector controls the resolution of the grayscale data in the terrain.



The terrain's resolution determines the amount of detail in your terrain. The higher the resolution, the more detail appears in your terrain's surface. However, higher resolution values also increase the rendering time for your scene and require more memory.

The highest resolutions should be reserved for terrains that are very close to your camera or where detail is important. For terrains that are far away, or where detail is not so important, lower resolutions are more appropriate.

TO SET THE TERRAIN RESOLUTION USING THE GRID SELECTOR:

- Click the Grid selector icon at the bottom of the Paintbrush controls and choose a resolution from the menu.

Brush sizes may appear to vary depending on your resolution, but in fact they remain proportional to the size of the Terrain Canvas.

ANIMATION CONTROLS

The Animation controls at the bottom of the editor let you create key frames for your terrain. Any change you make to the geometry of the terrain can be stored in a key frame and animated.

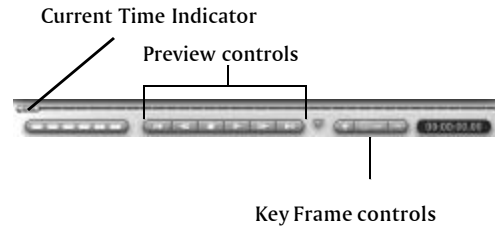

The Animation controls let you create key frames for the terrain so you can animate the terrain editing process.

The Timeline that runs along the bottom of the editor displays the length of the animation. The Current Time Indicator within the timeline lets you set the current time of the animation.

The buttons in the Animation controls let you preview the animation. The buttons beside the Preview controls let you add and delete key frames from the Timeline.

USING TERRAIN Editor Tools

The Editing tools are organized in three tabs:

- Elevation — contains tools for generating terrains, and applying effects.
- Filtering — contains tools for fine-tuning the gray levels in your Terrain Canvas.
- Pictures — contains tools for importing a picture to use as a height map.

TO ACCESS A TAB:

- Click the tab label. The tools associated with that tab move to the front. By default, the Elevation tools are in front.

Most of the tools in the Terrain Editor are displayed as control dots. These dots let you apply an effect or operation to the terrain gradually or at 100%.

To apply an editing tool to the Terrain Canvas:

- 1 Move the cursor over the tool you want to use.
- 2 Do one of the following:
 - To apply an effect or operation at full strength, click the control dot once. Clicking a tool more than once applies the effect in 100% increments.
 - To apply an effect gradually, click and drag over the control dot.

STARTING A NEW TERRAIN

By default, when you open the Terrain Editor, the terrain you selected in the Working window appears in the Terrain Canvas. If you want to begin with a new, flat Terrain Canvas, use the New button.

To create a new Terrain Canvas:

- 1 Click the Elevation tab.
- 2 Click the New button.
or press Command/Ctrl+N.
A flat black image appears in the Terrain Canvas.

To gradually flatten your terrain:

- Click and drag to the right over the New button.
The existing Terrain Canvas gradually fades to black.

Many of the effects in the Elevation tab require gray-scale values. If you apply these effects to a black map they may have no effect.

To reset your terrain:

- Hold down Control and click the New button.
The Terrain Canvas is reset to the terrain that appeared when you first opened the editor.

INVERTING TERRAINS

Since the Terrain Editor uses brightness to determine altitude, you can change mountains into canyons by inverting the black and white values in your image.

To invert your terrain image:

- 1 Click the Elevation tab.
- 2 Click the Invert button, or press Command/Ctrl+I.

All the black areas of your image become white and white areas become black.

To gradually invert your terrain image:

- Click and drag to the right over the Invert button.

The black areas in the Terrain Canvas progressively turn white.

Undoing Operations

You can reverse any effect you apply to your terrain using the Undo button. You can toggle between Undo and Redo by clicking the Undo button repeatedly.

To undo operations in the Terrain Editor:

- 1 On the Elevation tab, click the Undo button, or press Command/Ctrl+Z.
The last operation you applied is undone.

ERODING TERRAINS

Erosion simulates the effects of water erosion on your terrain objects. The calculations simulate rainfall and runoff based on the shades of gray progressing towards black. This effect works best on terrains that have large sloping areas.

The Erode button simulates the effects of erosion over relatively short periods of time, like decades. To simulate the effects of centuries of erosion, use the Eroded tool.

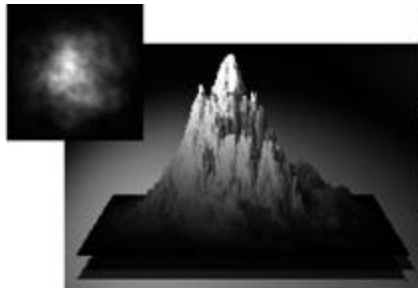

This is what a terrain looks like before you apply the Erode effect. Notice that this image map has sloping areas that will make the erode effect more visible.

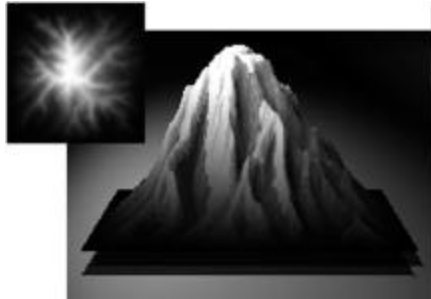

This is the same terrain after the Erode effect is applied. You can see how the surface now contains tracks created by running water.

To ERODE TERRAINS:

- 1 Click the Elevation tab.
- 2 Click the Erode button. To gradually apply erosion, click and drag while the pointer is over the Erode button.

Using THE ZOOM AREA

When the Zoom Area is active, only a small portion of your terrain is displayed in the 3D Preview. The 3D Preview displays the zoomed-in portion of your Terrain Canvas. You can use this feature to see small variations in the surface of your terrain. The Zoom Area can be moved to any point on your Terrain Canvas.

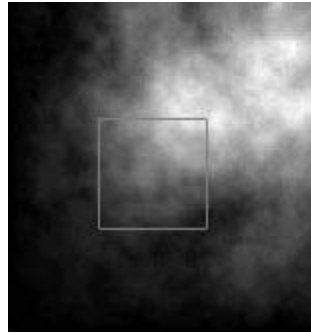

Use the Zoom Area to see a close up of an area in your Terrain Canvas in the 3D Preview.

You can always paint while the Zoom Area is active; in fact this is a nice way to paint in the Terrain Canvas while previewing a small section in the 3D Preview to observe details.

To TURN THE ZOOM AREA ON OR OFF:

- Click the Zoom Area button in the Terrain Canvas tool area.
This toggles a marquee on your Terrain Canvas.

To MOVE THE ZOOM AREA:

- 1 Move your pointer over an edge of the Zoom Area marquee. The pointer changes to a hand tool.
- 2 Drag the marquee to an area in the Terrain Canvas.

To RESIZE THE ZOOM AREA:

- 1 Move the pointer over a corner of the Zoom Area marquee. The pointer changes to an arrowhead cursor.
- 2 Drag away from the center of the marquee to enlarge the Zoom Area, or towards the center to shrink the area.

To scale the zoom area to fill the Terrain Canvas:

- Click the Crop button below the Zoom Area button in the Terrain Canvas tool area.
The contents of your Zoom Area are scaled to fill the entire Terrain Canvas area. The Zoom Area contents replace the existing contents of the Terrain Canvas.

This feature can be useful for creating new terrains from larger high-resolution terrains.

To fit the contents of the Terrain Canvas into the Zoom Area:

- Click the Fit text button below the Zoom Area button in the Terrain Canvas tool area.

The entire contents of your Terrain Canvas are scaled down to fit into the Zoom Area marquee. The rest of the Terrain Canvas is filled with black.

ELEVATION Tools

The Elevation tools are preset effects that apply calculations to your Terrain Canvas. The tools are divided into three categories on the tab: Source Generator, Basic Tools, and Special Effects.

Source Generators create basic terrain surfaces. The Basic Tools edit the overall shape of your terrain, and Special Effects add realism to your terrain's surface.

You can create a terrain by combining effects. For example, you can start off creating a basic terrain using the Fractal tool, then create realistic ridges by applying the Erode tool. From there you can fine-tune your terrain by applying Spikes, creating Mounds or adding Cross Ridges. Finally, you can define the basic shape of your terrain by blurring the edges.

To use an elevation tool:

- 1 Click the Elevation tab.
- 2 Click an effect tool. 100% of the effect is applied to the Terrain Canvas.

- 3 Click the tool again to increase the intensity of the effect.

Most elevation effects can also be applied gradually.

To apply an elevation effect gradually:

- 1 Move the pointer over an Elevation tool. The pointer changes to a two-headed arrow.
- 2 Click and drag to the left to increase the effect or click and drag to the right to decrease it.

FRACTAL

The Fractal tool creates terrains based on fractal patterns. It can be applied to an existing image and it can be applied gradually.

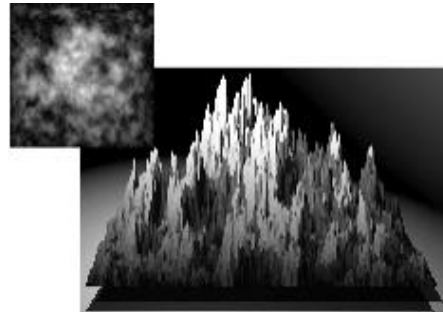

The Fractal tool produces terrains based on fractal patterns. The terrains it creates tend to have lots of spikes and valleys. This tool produces good basic terrains.

ERODED

This tool applies natural erosion to your terrain. It can be applied to either a blank image or an existing image. You can also gradually apply erosion to an image. The Eroded tool is a more intense version of the Erode tool.

Notice that when animating this type of terrain, material is actually added to the terrain, not removed from it as you might expect.

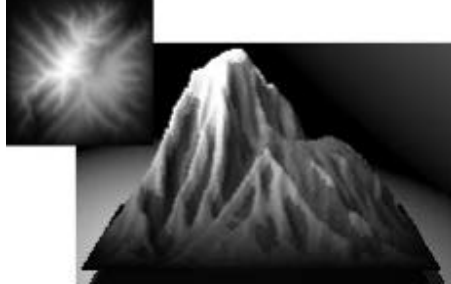

This tool produces terrains based on eroded land. The terrains produced by this tool have deep grooves and canyons.

PICTURE

This tool creates terrains from imported images. When you click this tool, the Open dialog appears. You can use this dialog to locate and load a picture to use as a Terrain Canvas. Refer to "Working with Pictures" on page 83 for more information.

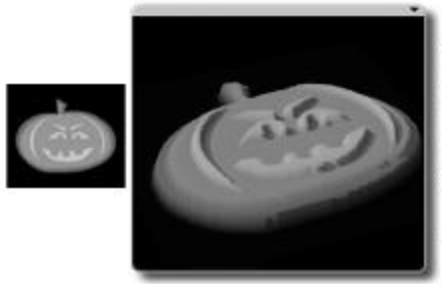

You can produce terrains based on a picture. You can import image maps created in other graphics applications.

Using this tool you can import an image map created in another application like Painter or Photoshop.

RAISE/LOWER

This tool adjusts the brightness of your Terrain Canvas. Click and drag to the right to lower your height map or click and drag to the left to raise it. Single clicks gradually lower the map.

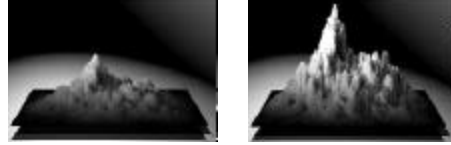

This tool adjusts the brightness of your Terrain Canvas, which raises or lowers the height of the entire terrain.

SHARPENING

This tool sharpens the gray values in your Terrain Canvas. Click and drag left to increase sharpening and right to decrease it.

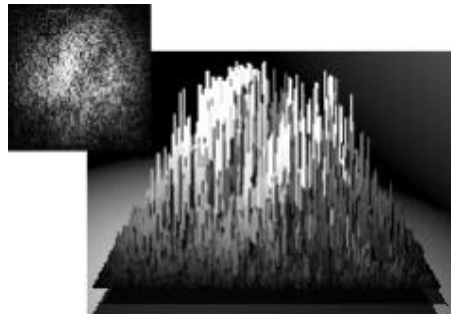

This tool sharpens the Terrain Canvas gray values. You can use smoothing to create spikes or ridges.

SMOOTHING

This tool blurs the Terrain Canvas. Click and drag right to decrease the blurring effect or left to increase it.

Smoothing is especially effective prior to using the Erode button, since the Erode algorithm works best when there are shades of gray in an image. If your canvas has too many sharp black to white transitions, the Erode may not be as effective.

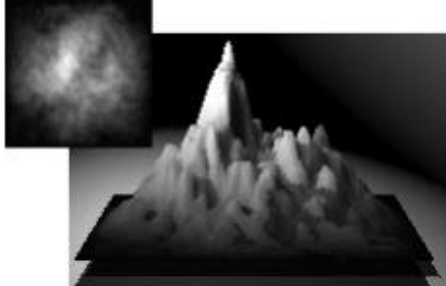

The Smoothing tool blurs your Terrain Canvas creating smoother black to white transitions.

GAUSSIAN EdGES

This tool does not blur your map. It creates a “Gaussian curve” from dark to light, starting from the edges of your Terrain Canvas. This creates edges that gradually transition from dark to light, or start at the lowest possible altitude, and gradually progress into higher altitudes.

Gaussian Edges eliminates the seams between ground and terrain objects, when the ground plane and the terrain have the same surface material. You should apply this tool to any terrain that is going to be sitting on a ground plane in your scene.

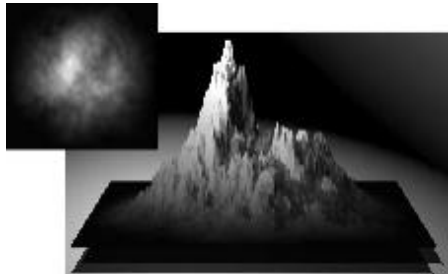

This tool creates gradually ascending edges on your terrain which can create a smooth transition from the ground plane of your scene to the terrain.

SQUARE EdGES

This tool creates an abrupt drop at the edges of your terrain. Use this tool when you have a terrain whose edges are not level, and you do not wish to use the Gaussian Edges tool for soft transitions.

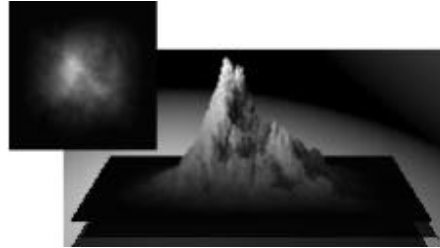

This tool creates an abrupt drop at the edges of your terrain. Use Square Edges to level the edges of a terrain.

You can add a slope to the square edges of your terrain by applying this tool gradually. Click and drag left to increase the slope and right to decrease it.

ROUND EdGES

This tool creates an abrupt circular drop at the edges of your terrain. You can add a slope to the round edges of your terrain by applying this tool gradually. Click and drag left to increase the slope and right to decrease it.

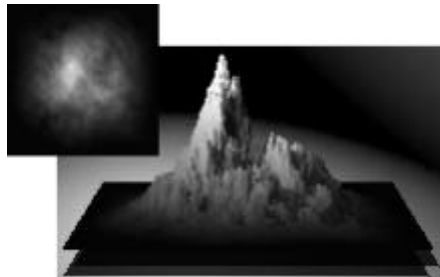

This tool creates an abrupt circular drop at the edges of your terrain. Use Round Edges to create a circular base for your terrains.

BASIC NOISE

This tool adds roughness to your terrain's surface by adding noise to the Terrain Canvas. Click and drag left to increase the noise and right to decrease it.

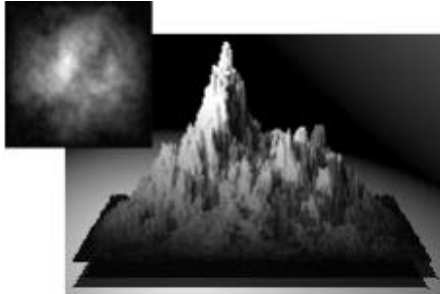

This tool adds roughness to your terrain's surface. Use Basic Noise to create rocky mountains.

SLOPE NOISE

This tool adds roughness to any sloping surfaces in your terrain. Click and drag left to increase the noise and right to decrease it.

Slope Noise has no effect on flat surfaces. More noise is added to steep slopes.

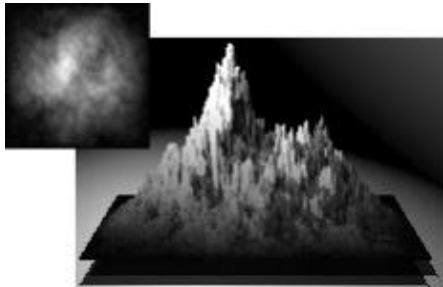

This tool adds roughness to the sloping surfaces of your terrain.

HEIGHT NOISE

This tool adds small amounts of noise at lower altitudes and more noise at higher altitudes. Click and drag left to increase the noise and right to decrease it.

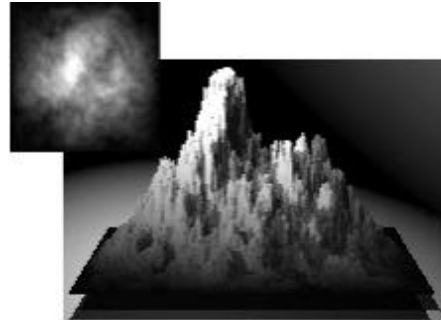

This tool adds a little roughness to your terrain's surface at lower altitudes and more at higher altitudes.

IMAGE FILTERING EFFECTS

These tools, located below the Noise tool, apply filters to your terrain that act like image filters. They can change the look of the terrain without altering its basic shape.

SPIKES

This tool adds spiky structures to your map. When you apply the right material to these structures they can look remarkably like trees when viewed from a distance.

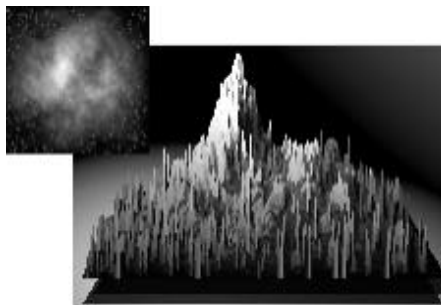

This tool adds spikes to your terrain's surface. Use Spikes when you want to add trees to your terrain.

Mounds

This tool adds mid-sized splotches to your canvas. You can use this tool to create the appearance of stones or boulders under transparent water planes.

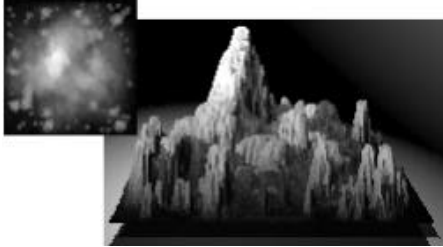

This tool adds splotches to your Terrain Canvas that look like boulders on flat surfaces or towers on sloped surfaces.

DAMPEN

This tool works like a contrast control. It will push gray values towards either black or white depending on where the gray value falls in the black/white range. Less than 50% goes to black, greater than 50% goes to white.

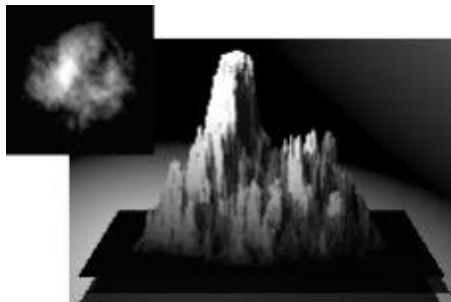

This tool controls the contrast of your Terrain Canvas. Use Dampen to create abrupt drops and valleys.

EQUALIZE

This tool acts like the Equalize function you may have seen in 2D image editing applications. It redistributes gray values in your Terrain Canvas such that a full range from black to white is present in your canvas.

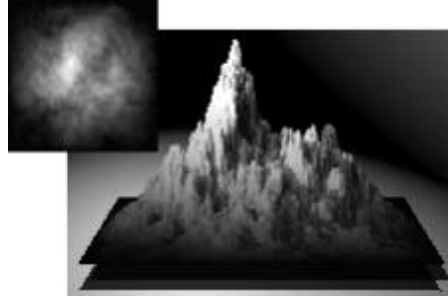

This tool equalizes black and white values in your Terrain Canvas. Use Equalize to eliminate sharp ridges or deep valleys.

POSTERIZE

This tool stratifies the gray levels in your Terrain Canvas, resulting in stair-stepped terrain structures. This is a good tool for creating desert plateaus.

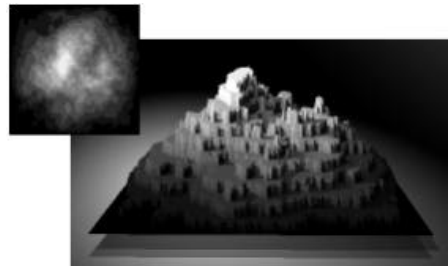

Use Posterize to create stair-stepped desert plateaus or paddy fields on the side of a mountain.

Mosaic

This tool is not a button on the Elevation tab. To use this tool, hold down Opt/Alt as you drag over the Posterize button.

Mosaic creates highly pixelated square structures based on the gray content of your canvas.

This tool is excellent for instant cityscapes. Try adding one of the sci-fi city materials from the Preset Materials Library to a Mosaic terrain.

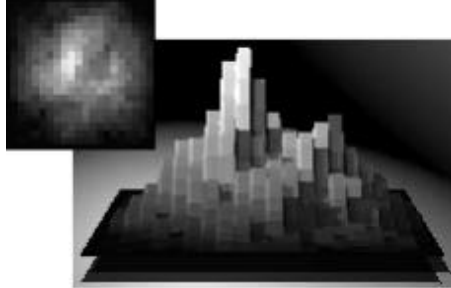

This tool pixelizes your Terrain Canvas. Use Mosaic to create cityscapes.

SAWTOOTH

This tool modifies your Terrain Canvas based on a sawtooth waveform structure. The results look like desert canyons and icebergs.

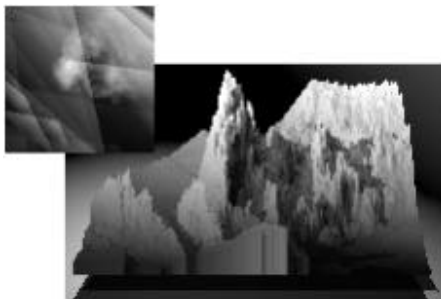

This tool creates desert canyons or icebergs.

SUBCONTOURS

This tool works like a contrast control with the threshold set almost at white. Most values are pushed to black while only the very lightest are pushed to white. Subcontours produces spiky peaks with very low, gently sloping contours.

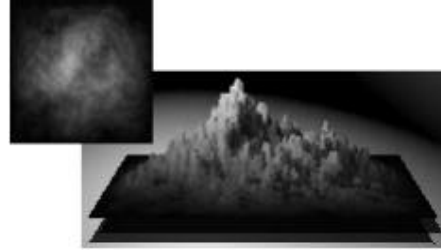

This tool produces spiky peaks with sloping contours.

BLOB MAKER

This tool creates a smooth, circular structure within your existing Terrain Canvas. Click and drag left or right to change the size of the structure. Click and drag up and down to set the vertical location of the structure.

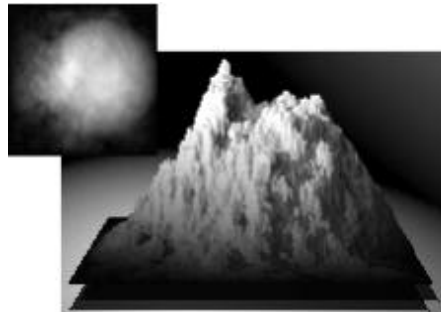

This tool creates circular structures within your Terrain Canvas.

RELIEF NOISE

This tool acts like an emboss effect. It will emboss the grayscale data in your canvas and convert it to height information.

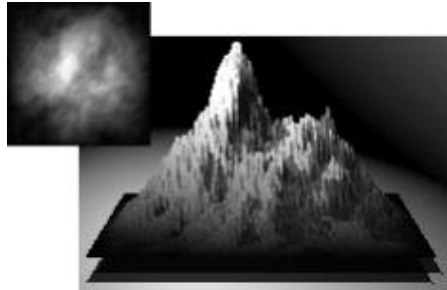

This tool embosses the grayscale data in your Terrain Canvas.

RAISE EDGES

This tool acts like an inverted version of the Square Edges tool. It creates abrupt increases in altitude at the edges of your terrain.

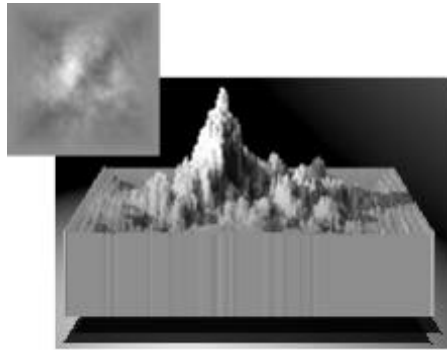

This tool creates abrupt increases in altitude at the edges of your terrain.

SUBPLATEAUS

This tool smears your grayscale data in one direction while averaging the gray values. The result is natural structures not unlike those created by the Mounds effect, except that these structures are more directly related to your original graydata.

Because it creates boulder-like structures, this tool is good for making tidepools.

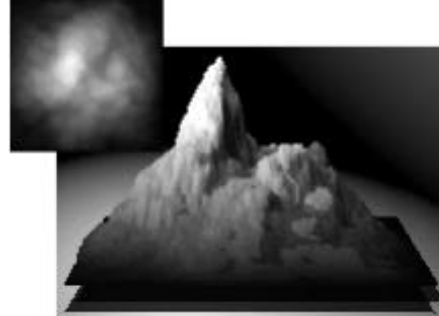

This tool creates boulder-like structures within your Terrain Canvas.

CROSS RIDGES

This tool creates sharp ridges in a cross pattern. It creates very interesting canal-like structures.

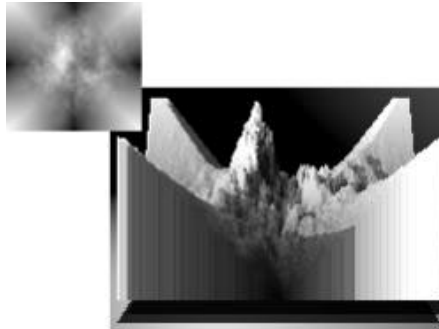

This tool creates canal-like structures within your terrain.

CROSS RIDGES 2

This tool is the inverse of the Cross Ridges tool. Instead of creating canals, it creates peaks.

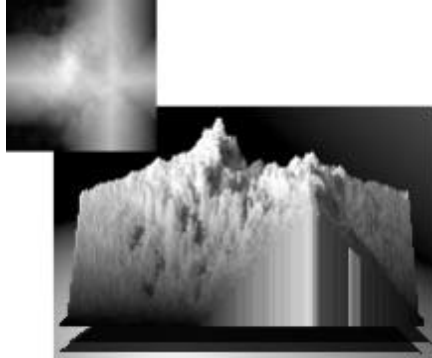

This tool creates peak-like structures within your Terrain Canvas.

Bubble RIDGES

Similar to the Blob Maker, the spherical structure this tool creates is of a consistent size. Dragging this button allows you to place the structure anywhere you like in your canvas.

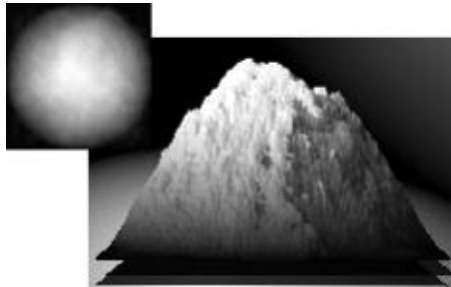

This tool creates a spherical structure within your terrain that can be placed at any point in your canvas.

Using THE PAINTBRUSH

While you're painting, you may want to re-create a specific altitude in different parts of the terrain. If you've changed the brush settings, re-creating a specific altitude can be quite difficult. However, using the Height Picker tool, you can quite easily re-create altitudes by picking up gray levels from different parts of your image and applying them to the brush.

To pick up GRAY LEVELS FROM THE TERRAIN IMAGE:

- 1 While holding down the spacebar, move the cursor over the Terrain Canvas and click the desired altitude color. The color is applied to the brush.
- 2 Drag the brush over a different area of the canvas. The altitude color you picked up is applied to the new area.

BRUSH BEHAVIORS

The Paintbrush in the Terrain Editor paints elevations by default, but this is not the only way of painting using the brush. You can also set the brush to paint effects. This lets you apply elevation effects locally, or to increase/decrease existing gray levels in your Terrain Canvas.

To PAINT ELEVATIONS:

- 1 Click the Menu icon on the Terrain Canvas.
- 2 Click the triangle icon below the Brush Behaviors heading and choose Elevation from the menu.

The brush paints in shades of gray that are then used to generate altitudes. This is the default brush behavior.

To apply AN EFFECT locally:

- 1 Click the Menu icon on the Terrain Canvas.
- 2 Click the triangle icon below the Brush Behaviors heading and choose Paint Effect from the menu.
- 3 Click the Elevation tab in the Editing tools palette.
- 4 Hold down the Spacebar and click the Elevation effect you want to paint.
- 5 Drag the paintbrush over an area of your canvas.

To REMOVE AN EFFECT locally:

- 1 Click the Menu icon on the Terrain Canvas.

- 2 Click the triangle icon below the Brush Behavior heading and choose Unpaint Effect from the menu.
- 3 Drag the paintbrush over an area of your canvas where you applied an effect locally.

The Unpaint Effect brush only affects areas where you applied an effect with the paintbrush.

An effective way of using this brush is to paint an effect in broad, easy strokes, and then selectively unpaint areas of effect.

To erode areas of your terrain:

- 1 Click the Menu icon on the Terrain Canvas.
- 2 Click the triangle icon below the Brush Behaviors heading and choose Erode from the menu.
- 3 Drag the paintbrush over the area you want to erode.

The paintbrush applies the erosion effect to the area painted over.

To lighten gray levels:

- 1 Click the Menu icon on the Terrain Canvas.
- 2 Click the triangle icon below the Brush Behavior heading and choose Maximum from the menu.
- 3 Drag the paintbrush over an area you want to lighten.

In this mode, gray levels in your canvas that are below the current gray level are lightened to match the current level. Values above the current level setting are untouched.

To darken gray levels:

- 1 Click the Menu icon on the Terrain Canvas.
- 2 Click the triangle icon below the Brush Behavior heading and choose Minimum from the menu.
- 3 Drag the paintbrush over an area you want to darken.

Gray levels in your canvas that are above the current gray level are darkened to match the current level. Values below the current level setting are untouched.

Modifying BRUSH BEHAVIOR

The Option/Alt key can modify the behavior of the paintbrush on-the-fly.

- In Elevation mode, Option/Alt inverts the gray level. For example, if you're painting white, holding down Option/Alt will paint black.
- In Paint Effect mode, the Option/Alt key will toggle to Unpaint Effect mode.

Hold down Shift to constrain the pen movements to 45 degree steps.

FILTERING TERRAINS

Filtering is the process of adjusting the grayscale curve of your Terrain Canvas. By adjusting the grayscale curve, you create a custom elevation effect.

How FILTERING Works

The Filter area is essentially a graph that represents gray level input from black to white horizontally, and gray level output from black to white vertically.

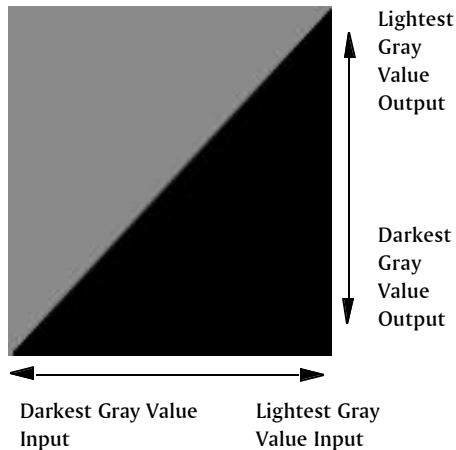

The Filtering graph expresses all the input and output gray values in your Terrain Canvas.

The default diagonal filter creates a graph where all values input as black are also output as black, and all values input as white are also output as white. That is why your Terrain Canvas appears unchanged—none of its gray level values have been altered.

By dragging in this Filter area, you can remap the gray values in your Terrain Canvas.

To see how filtering works:

- 1 Place your cursor (which changes to a Pen within the Filtering area) in the top left corner of the Filter Area.
- 2 Drag diagonally to the bottom right corner.
- 3 Click Apply.

As you can see in the Preview area, your Terrain Canvas is inverted.

The original graph showed that all values input as black were output as black and all the values input as white were output as white.

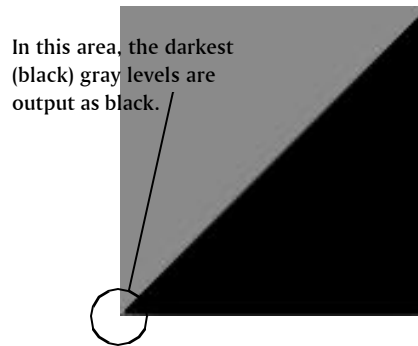

In the original Filtering graph all values input as black are output as black and all values input as white are output as white.

The new graph you created now shows that all values input as black are output as white and all the values input as white are now output as black. In other words all the dark values are light and all the light values are dark.

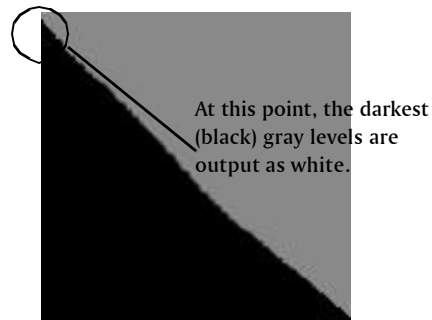

In the new Filtering graph all values input at 0 are output at 255 and all values input at 255 are output at 0.

This is a drastic example. In most cases you would adjust more selectively, like lightening the midtone grays or darkening specific gray values. Remember that this graph represents your Terrain Canvas, so you're changing the shape of your terrain object as you adjust gray values.

THE FILTERING TAB

The Filtering tab is divided into three areas: the Filtering Graph, the Preview area, and the Filtering Presets.

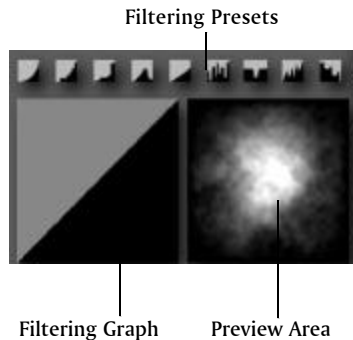

Use the Filtering tab to edit the Filtering graph and apply filtering presets.

The Filtering graph displays your Terrain Canvas's gray levels as value inputs and outputs. You can edit this graph to adjust the gray level values in your canvas.

Next to the graph is the Preview area. This area shows you what your Terrain Canvas would look like if applied to the current Filtering graph. This area automatically updates as you make changes to the graph.

Along the top of the tab are the nine Filtering presets you can apply to the graph. Each preset represents a different predefined graph. They are designed to create specific changes in gray levels, like smooth gradients and abrupt transitions.

WORKING IN THE FILTERING TAB

ALTERING THE FILTERING GRAPH

The best way to start adjusting the Filtering graph is to determine the type of effect you want to create. For example, if your canvas is too dark, raise the value of the darker gray value inputs by drawing a ridge in the left side of the graph.

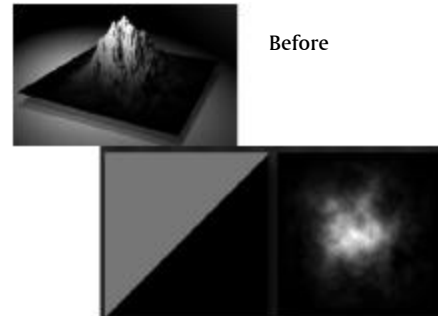

Drawing a ridge on the left side of the graph...

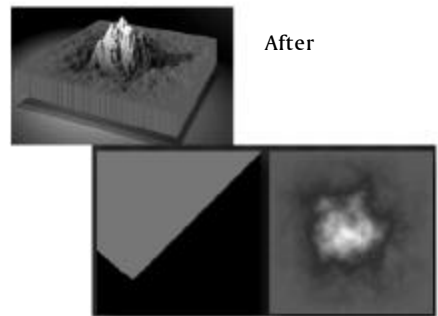

...raises the value of the darkest grays in your Terrain Canvas.

TO ALTER THE FILTERING GRAPH:

- 1 Click the Filtering tab.
- 2 Drag your pointer over the area of the Filtering graph you want to adjust.

When you drag over a black area, the pencil draws in gray; dragging over a gray area draws in black.

Tracing over any lines you've drawn erases them.

TO UNDO ALL CHANGES TO THE FILTERING GRAPH:

- 1 Click the Filtering tab.
- 2 Click the Reset text button below the Filtering graph.

The graph returns to the default Filtering graph.

To soften harsh transitions in the graph:

- 1 Click the Filtering tab.
- 2 Click the Smooth text button below the Filtering graph.
- 3 Click the Smooth button again to soften the transitions more.

Applying PRESETS

Filtering presets are provided to help you get started adjusting the Filtering graph. These presets are designed to provide different effects. The best way to understand these presets is to apply them to your graph and see what happens.

To apply PRESETS:

- 1 Click the Filtering tab.
- 2 Click one of the preset buttons along the top of the tab. The current graph is replaced with the preset graph.

Applying FILTERING CHANGES TO YOUR TERRAIN CANVAS

Although any changes you make to the graph are applied to the Preview area, they do not automatically affect your Terrain Canvas. You have to apply the changes before they affect the canvas.

You can temporarily apply your changes to the 3D Preview in real-time by holding down Control/Ctrl as you click and drag over the Filtering graph.

To apply the FILTERING GRAPH TO THE 3D PREVIEW:

- Click and hold the mouse button over the filter graph preview. The 3D Preview updates.
When you release the mouse the 3D Preview switches back to the unfiltered terrain.

To apply FILTERING CHANGES TO THE TERRAIN CANVAS:

- Click the Apply text button beneath the Preview area.

BLENDING THE FILTERING GRAPH WITH THE TERRAIN CANVAS

The Filtering Tab offers several ways of applying your Filtering graph to the Terrain Canvas. You can apply the graph directly or you can blend the graph with the canvas.

When you use a blending option you're essentially drawing a grayscale gradient and then blending it with your original canvas.

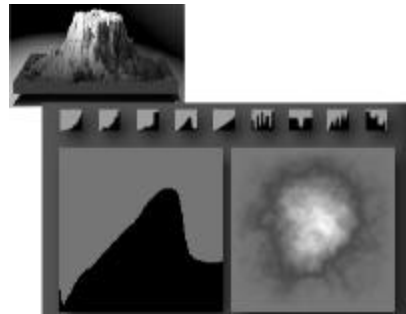

This terrain was altered by directly applying a filtering effect.

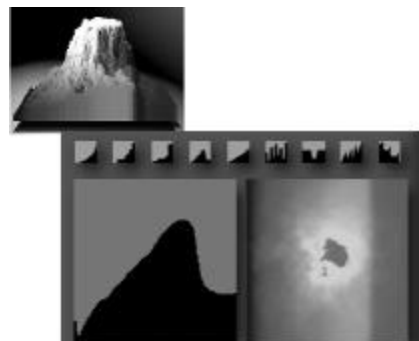

This terrain was altered by blending a filtering effect with the original canvas.

To blend the Filtering graph with the Terrain Canvas:

- 1 Adjust the Filtering graph to achieve the desired effect.
- 2 Click the triangle icon below the Filtering graph and choose an option from the menu:
 - Horizontal horizontally blends your Filtering graph, expressed as a grayscale gradient, with your Terrain Canvas.
 - Vertical vertically blends your Filtering graph, expressed as a grayscale gradient, with your Terrain Canvas.
 - Horizontal Add horizontally blends your Filtering graph, expressed as a grayscale gradient, with your Terrain Canvas.

This option uses a slightly different algorithm than the previous Horizontal option: it's not a traditional Additive, but an average of the existing terrain grayscale values with the maximum of the Terrain and Filter values.

- Vertical Add vertically blends your Filtering graph, expressed as a grayscale gradient, with your Terrain Canvas.

This option uses a slightly different algorithm than the previous Vertical option: it's not a traditional Additive, but an average of the existing terrain grayscale values with the maximum of the Terrain and Filter values.

- 3 Click Apply.

Using Creation Models

Bryce provides a selection of terrain models. When you select a terrain from the list of models, you get a randomized version of that model.

To access a terrain model:

- 1 Click the Pictures tab in the Editing tool palette.
- 2 Click Load.
- 3 Select a model from the menu that appears.

The last model you select becomes the default model.

CREATING TERRAINS USING PICTURES

The Terrain Editor converts grayscale values in the Terrain Canvas into altitudes to create terrain objects. You can take advantage of this process to create unique terrains based on the grayscale values in a picture.

The Terrain Editor's Picture tab lets you import a picture into the Terrain Canvas. You can then apply elevation effects or filters just as you would to any other Terrain Canvas.

THE PICTURES TAB

The Picture tab has three picture squares and a blend control. The first two picture squares let you load a picture to use as a terrain and the third square shows you the result of combining the two pictures. The blend control lets you specify how the pictures are combined.

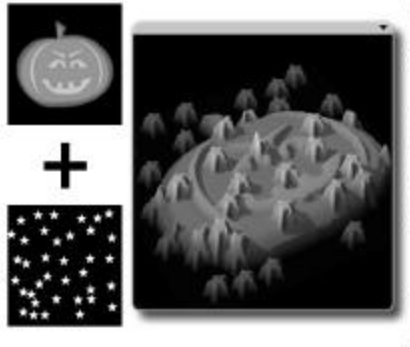

Use the Picture tab to load and blend pictures to create unique terrains.

WORKING IN THE PICTURES TAB

LOADING PICTURES

You can load any two pictures from your system. You can also paste images from the Clipboard.

To load pictures:

- Click the Load text button above the picture box into which you want to load the picture.

From the Picture button in the Elevation tab, hold down the Option/Alt key to load the picture's color data directly into the 3D Preview. This allows you to see the interaction between the picture and the gray-scale-to-height interpretation of its luminance values. The color data is only for viewing purposes and will not render with the terrain.

To copy and paste a picture into the Picture tab:

- 1 In another application, copy the picture you want to use to the Clipboard.
- 2 In the Picture tab, click the Paste text button below the picture box where you want the picture to appear.

When you use Command/Ctrl+V to paste from the Clipboard, the picture always appears in the first square.

BLENDING PICTURES

Once you have a picture in each of the first two squares, you blend them to create a third image that is used to create the new Terrain Canvas.

To blend pictures:

- 1 Load pictures into the first two squares.
 - If you load only one picture a white square is used as the second blend image.
- 2 Click the triangle icon under the third picture box and choose a Blend mode from the menu:
 - Blend compares each corresponding pixel from the first two squares, and displays an average of the two in the corresponding location of the third square.
 - Minimum compares each corresponding pixel from the first two squares, and displays the darker of the two in the corresponding location of the third square.
 - Subtract compares each corresponding pixel from the first two squares, subtracts the brightness value of one from the brightness value of the other, and displays the result in the corresponding location of the third square.
 - Add compares each corresponding pixel from the first two squares, adds the brightness value of one to the brightness value of the other, and displays the result in the corresponding location of the third square.
- 3 Drag the pointer over the Blend control.
 - Click and drag to the left to use more of the first image in the blend. Click and drag to the right to use more of the second image.

Applying CHANGES TO THE TERRAIN CANVAS

Although the result of blending pictures appears in the third picture box, it is not automatically applied to your Terrain Canvas.

To apply a picture to the Terrain Canvas:

- Click the Apply text button beneath the third picture square.

Adding Color to Terrains

Color in the Terrain Editor is used as a visual aid to help you see the relationship between color values and altitude. This color only exists in the Terrain Editor and is not applied to the terrain object.

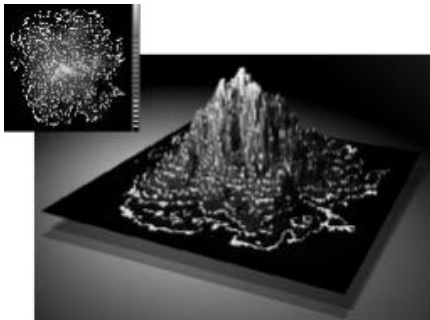

You can apply a color gradient to your Terrain Canvas to help you visualize the relationship between color values and altitude.

When you apply color in the editor, it maps a gradient to the altitudes in your Terrain Canvas. For example, if you apply a gradient from blue to yellow, blue might represent the lowest altitude while yellow may represent the highest. Which colors are mapped to which altitudes is left completely up to you.

Gradients can be extremely useful when you're filtering terrains, as they emphasize the differences between gray levels.

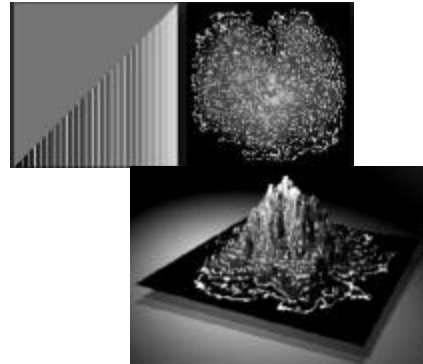

You can apply a color gradient to your Terrain Canvas. The color gradient also appears in the Filtering tab. This makes it easier to see the differences in gray levels.

MAPPING COLOR TO YOUR TERRAIN CANVAS

The Terrain Editor's color picker contains all the gradients you can apply to your terrain. The gradient you select is applied to both the Terrain Canvas and the 3D Preview.

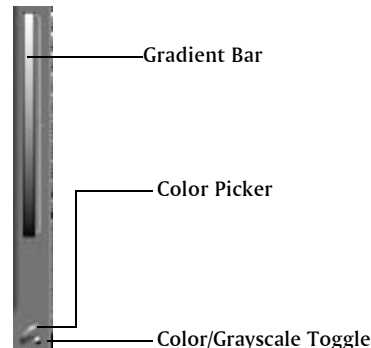

Use the Color Picker button to choose a color gradient and the gradient bar to set color mapping.

To map colors to your Terrain Canvas:

- 1 Click the Color Picker button in the bottom right corner of the Terrain Canvas Frame and drag over a gradient in the palette.

The gradient you select appears in the Gradient bar and is mapped to the Terrain Canvas and the 3D Preview.

- 2 Drag the gradient up or down to map the colors to altitudes.

The colors at the bottom of the gradient represent the lowest altitude and those at the top represent the highest.

The Gradient Bar has two modifiers:

- Opt/Alt resets the Gradient Bar.
- Command/Ctrl+F flips the colors in the gradient.

TO RETURN TO GRAYSCALE:

- Click the Color/Grayscale toggle to switch back to the default gray gradient.

Although gradients are meant to be used only in the Terrain Editor, you can apply the gradient to the terrain's Diffuse channel. The gradient then becomes the terrain's Diffuse color. This allows you to render the gradient with the terrain.

TO REMOVE A GRADIENT FROM A TERRAIN'S DIFFUSE CHANNEL:

- 1 Open the terrain in the Terrain Editor.
- 2 Click the Color/Grayscale toggle.

Clipping Terrains

Using the Terrain Editor's clipping controls, you determine which values in your terrain are rendered as the final terrain object. The Clipping controls next to the Gradient bar represent the render range for the terrain. Anything outside the range included in the brackets will not be rendered.

You can use these controls to eliminate unwanted information from the terrain without altering its basic shape. For example, you can keep the main terrain while eliminating the black square on which it sits.

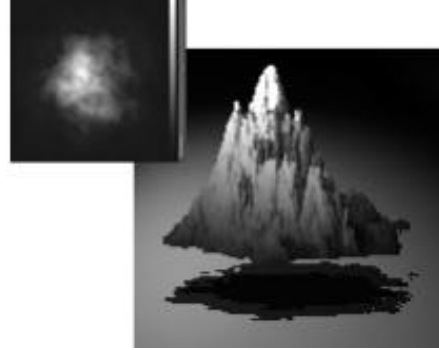

Using the Clipping Bracket you can eliminate unwanted areas from the terrain's edges. This feature can be useful when you're creating islands.

The clipping feature is particularly useful when editing a Symmetrical Lattice. The maximum lower range of the Clipping Bracket determines where the two halves of the Symmetrical Lattices are joined.

TO SET THE CLIPPING RANGE:

- 1 Drag the top of the Clipping Bracket to set the maximum upper range.

Any areas in the Terrain Canvas whose gray levels fall outside the bracket's maximum upper range will appear colored to indicate they will be omitted from rendering.

- 2 Drag the bottom of the Clipping Bracket to set the maximum lower range.

Any areas in the Terrain Canvas whose gray levels fall outside the bracket's maximum lower range will also appear colored to indicate they will be omitted from rendering.

The out-of-range colors for upper and lower limits are different, to better enable you to distinguish upper and lower clipped areas at a glance. Upper out-of-range color is usually yellow, and lower out-of-range is usually red, though the colors change for many of the color maps.

TO RESET THE CLIPPING BRACKET:

- Hold down Option/Alt and click the bracket.

TO MOVE THE ENTIRE Clipping BRACKET AT ONCE:

- Click the center of the Clipping Bracket and drag up or down.

Terrain objects are hollow, so if you clip the upper range off your terrain, you'll be able to see through the top of the terrain to whatever is underneath. To make the top solid, you should select Solid from the drop-down menu at the top right of the Terrain Canvas.

SAVING TERRAINS

Since the terrains you create in the Terrain Editor are objects in the scene, you can save any terrain in the Preset Objects Library just as you would any object. Refer to "Adding and Deleting Preset Objects" on page 75 for instructions on saving objects to the preset library.

EXPORTING TERRAINS

The Export Terrain Lab allows you to convert Bryce terrains into polygonal meshes. The Lab provides you with full control over the level of detail in the polygonal mesh.

You can adjust the number of polygons with realtime feedback so you can instantly see the resulting change to your mesh.

In addition, the Lab allows you to manage the all-important texture maps so that your exported meshes retain the cool look as generated within Bryce.

TO ACCESS THE EXPORT TERRAIN LAB:

Do one of the following:

- Select a terrain in your scene and go to File menu > Export Object,
- or

- Edit and save a terrain in the Terrain Editor and click Export, which is located at the bottom of the map view.

FEATURES OF THE EXPORT TERRAIN LAB

The Export Terrain Lab is divided into two areas:

- The polygonal mesh previewer with polygon count slider.
- The image map controls.

The mesh previewer allows you to instantly examine the quality of the current tessellation.

TO MANIPULATE THE MESH:

- To rotate the mesh, click and drag in the previewer.
- To zoom the mesh in and out, Command/Control-click and drag in the previewer.
- To change the previewer display mode, select one of the buttons to the right of the previewer.

Available preview modes are: Wireframe, Shaded, Textured, and Textured With Wireframe Overlay.

- To adjust the colors of the wireframe and the shaded preview, select the color swatches underneath the preview mode buttons.
- To adjust the polygon count, move the slider below the previewer. This changes the quality of your mesh. The number of polygons in the mesh is displayed in the right bottom corner of the previewer.

PREVIEW OPTIONS

Selections on the right hand side of the Preview window allow you to preview your terrain in the following ways:

- Wireframe
- Shaded
- Textured

- Textured with Wireframe Overlay

Types of Tesselations

You can create two types of tessellations in the Export Terrain Lab: Grid and Adaptive.

The default method is Grid Triangulation. The initial tessellation is set to 5,000 polygons. If this is not sufficient you can add polygons by selecting Add Polygons in the drop down menu at the right bottom corner of the previewer.

To switch between tessellation types:

To switch between Grid and Adaptive tessellations, click on the triangle to the left of the previewer and select the tessellation type.

Grid Tesselations

Grid tessellates the original height field with a grid.

In order to achieve a good mesh representation of the source terrain, selecting Grid requires a large number of polygons. This method is suitable for geometric shapes.

Adaptive Tesselations

Adaptive achieves much lower polygon counts with good representation of the terrain.

This is an excellent choice when the terrain models natural landscapes.

Exporting to MetaStream

When exporting to MetaStream, you can select additional options: Clamp Minimum and Clamp Maximum.

These options define the lowest and highest polygon counts within the multi-resolution mesh.

To reset the Clamp Minimum and Clamp Maximum:

- Select Reset Clamps within the Options menu.

To apply the Clamps:

- 1 Use the slider to set the desired lower polygon count.
- 2 Select Options menu > Clamp Minimum.
- 3 Use the slider to set the desired higher polygon count.
- 4 Select Options menu > Clamp Maximum

If Clamp Minimum and Clamp Maximum are set to the same amount, the MetaStream file will contain a single resolution.

Handling Image Maps

The second area of the Export Terrain Lab deals exclusively with handling image maps.

A large part of the appeal of Bryce terrains are Bryce materials, which consist of different significant properties. Each of these properties can be exported, along with their geometry, through the Export Terrain Lab.

The image map controls let you refine which of the material properties you wish to export by selecting out of the list of ten. By default any material properties of the terrain that use image maps will be exported.

Depending on the selected export file format, the image maps will be embedded within the export file. If, however, the export file format does not support embedding of image maps, they will be saved as separate image files in the same folder as the export file. The filename of each separated image will be the name of the export file appended with the name of the appropriate material property.

To adjust the resolution of the exported image maps:

- Select one of the presets in the Size menu.

To save the tessellated terrain and all its image maps:

- Click on the OK icon.

If you do not wish to save, click on Cancel.

To export a terrain:

- 1 Create a terrain and apply materials.
- 2 Either select the terrain and go to File > Export Object or enter the Terrain Editor and click Export.
- 3 Choose the desired file format and target folder.
- 4 Adjust the complexity of the mesh.
- 5 Select material properties to be exported as image maps.
- 6 Select image map size.
- 7 Click the OK icon to cause the tessellated mesh to be written to the exported file.

longer to render than smooth shaded surfaces. This will keep you working rapidly on your composition. Then, before your final output, you can take some time to design textures for your terrain.

Tips for Speeding Up the Terrain Editor on Slower Machines

To speed up performance on slower machines, disable both the Realtime Linking and AutoRotate options.

To speed up the Elevation effects, use the single-click method rather than the click- drag “dial in” method, as the latter can be quite slow.

The larger terrain grid sizes, such as Massive, Gigantic, and Planetary, require a significant amount of memory and computing power. Only use these terrain grid sizes when necessary. If you are working on a slower machine, you may experience problems such as “out of memory” errors.

When you create a terrain in your Bryce scene, a natural impulse is to immediately dress it up with a cool material and render it right away to see what it looks like. For serious composition, consider keeping your terrains free of textural attributes until the final stages, as procedural textures take

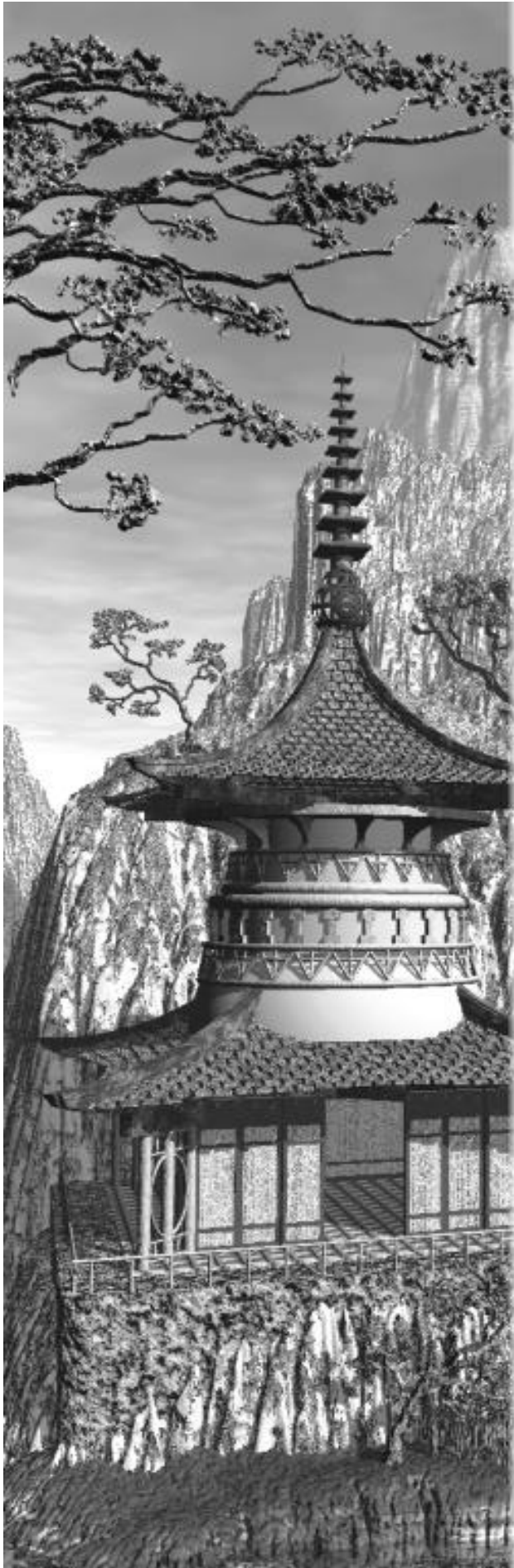

6

EDITING TREES

New in Bryce 5 is the ability to create organic tree shapes. This lets you add realistic or 'fantasy' trees to your scenes. You can then customize your trees in the Tree Lab by assigning materials, controlling the shape of trees, and more.

Trees have four essential components: the overall shape, the trunk, the branches, and the foliage. How these elements are shaped and organized around each other defines the appearance of the tree.

The overall shape of trees varies greatly between species. In general, trees have several feet of trunk before they begin to branch out, and the branches eventually form a crown. The shape of the tree can vary greatly within these criteria. For example, the sugar maple has an almost spherical silhouette; a poplar tree has a cylindrical shape that tapers to a point at the top; and conifers such as pine trees have a triangular shape.

The width of the trunk generally indicates the age of the tree; however, different species of trees have different widths when mature. A birch tree, even when quite old, will not have as wide a trunk as an oak tree of the same age. The texture of the trunk can also be a good indicator of the species or age of the tree; the trunk generally becoming coarser with age.

The characteristics of branches, such as their thickness, how the branches are arranged on the trunk, how they are positioned relative to each other, and how they are affected by gravity can also vary greatly between species. For example, a weeping willow tree has branches that begin growing upwards from the trunk but are so thin that gravity bends them towards the ground, giving the tree a distinctive, drooping appearance. Some species of conifers have symmetrically spaced and sized branches, giving them a very geometric appearance.

Finally, the foliage of the tree is probably the most obvious indicator of species. Species of trees have greatly varying leaf shapes and colors. Oak and ginkgo trees are both easily recognized by the distinctive shape of their leaves.

The variations in trees are virtually limitless. You need only look at the wide variation found in nature for inspiration when creating and customizing trees in Bryce.

WORKING WITH THE TREE LAB

The Tree Lab lets you control the various attributes of tree objects. Using the tree lab, you can edit the trunk, branches, and foliage of a tree object to achieve a particular look.

You cannot access the Tree Lab unless you have a tree object in your scene. When the Tree Lab opens, it temporarily replaces the screen and displays the currently selected tree object in the Tree Preview.

TO OPEN THE TREE LAB:

- 1 Select a tree object in your scene.
- 2 Click the E icon that appears next to its bounding box, or choose Objects menu > Edit Object. The Tree Lab appears.

MIN/MAX SLIDERS

The Tree Lab uses a unique kind of slider for setting some of the attributes of the trunk and branches. These sliders, called Min/Max sliders, let you set both the minimum and maximum values for an attribute using the same slider. Bryce will choose a random value between the specified minimum and maximum when generating the tree.

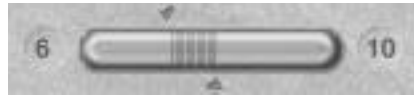

A Min/Max slider.

TO SET THE MAXIMUM VALUE:

- Drag the arrow below the Min/Max slider to the desired value.

TO SET THE MAXIMUM VALUE NUMERICALLY:

- 1 Click the field to the right of the Min/Max slider.
- 2 Type a value in the field.

TO SET THE MINIMUM VALUE:

- Drag the arrow above the Min/Max slider to the desired value.

TO SET THE MINIMUM VALUE NUMERICALLY:

- 1 Click the field to the left of the Min/Max slider.
- 2 Type a value in the field.

FEATURES OF THE TREE LAB

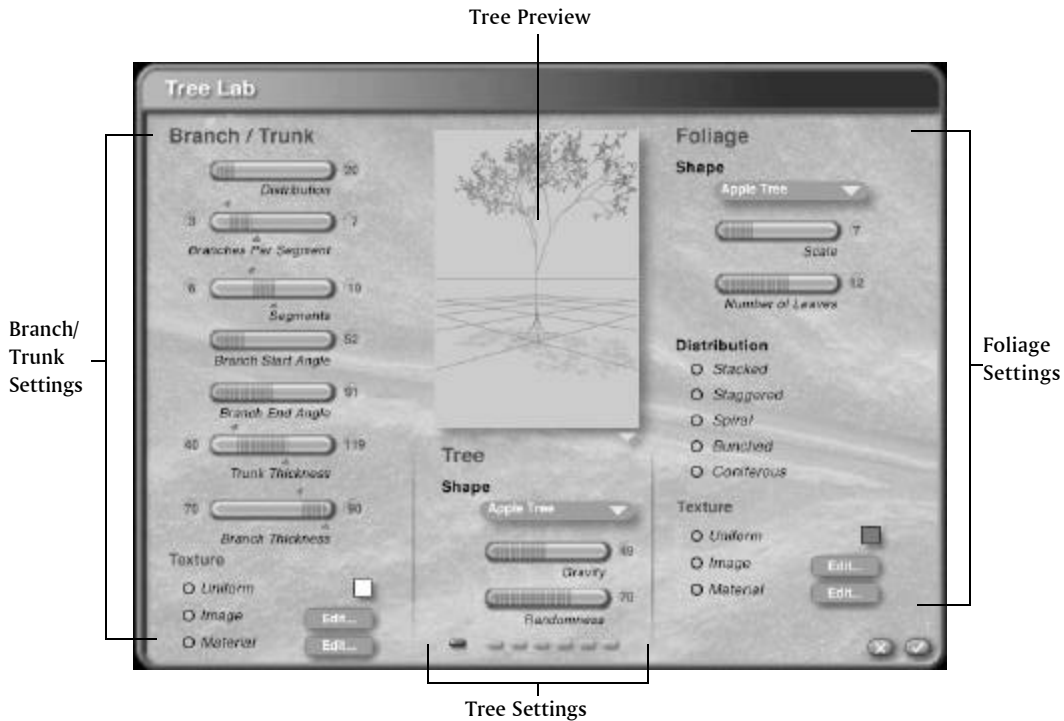

The Tree Lab is divided into four sections:

- Tree Preview — lets you preview changes to your tree.
- Branch/Trunk — lets you control the size of the tree trunk; the placement, number, and thickness of branches; and the materials used for the trunk and branches.
- Tree — lets you control the overall shape of the tree, the randomness of the tree, and how gravity affects the tree.
- Foliage — lets you control the overall shape of individual leaves, the scale and number of leaves, the distribution of the leaves, and the materials used for the leaves.

TREE PREVIEW

The Tree Preview, located in the center of the Tree Lab, displays the resulting tree object based on changes you make to the settings in the Tree Lab. The Tree Preview does not update automatically; after you have made a series of changes, click the Tree Preview to update it.

The Tree Preview has two preview modes: Normal View and Up Close. Normal View displays the entire tree object. Up Close displays a more detailed view by zooming in on the tree object.

There are also two render modes for the Tree Preview: **Render With Neutral Sky** and **Render With Neutral Ground**. These options are enabled by default and are designed to speed up the Tree Preview rendering.



The Tree Preview.

To update the Tree Preview:

- Click anywhere in the Tree Preview.

To choose a preview mode:

- 1 Click the triangle below the Tree Preview.
- 2 Choose a preview mode in the drop down menu.

To turn a render mode on or off:

- 1 Click the triangle below the Tree Preview.
- 2 Click the render mode in the drop down menu. When the render mode has a checkmark beside it, it is currently active.

*To speed up rendering in the Tree Preview, turn on both **Render With Neutral Sky** and **Render With Neutral Ground**.*

BRANCH/TRUNK SETTINGS

You can use the Branch/Trunk settings located on the left side of the Tree Lab to control the thickness of the trunk and branches, the distribution of branches around the trunk, the number of

segments, the number of branches per segment, the starting and ending angles of the branches, and the texture used for the trunk and branches.

TRUNK THICKNESS

The Trunk Thickness slider lets you specify a minimum and maximum width of the trunk, from 1 to 200. The minimum width controls the thickness of the twigs at the outermost reaches of the tree while the maximum width controls the base of the tree.

To set the maximum trunk thickness:

- Drag the arrow below the Trunk Thickness slider to the desired value, or type a value in the field to the right of the slider.

To set the minimum trunk thickness:

- Drag the arrow above the Trunk Thickness slider to the desired value, or type a value in the field to the left of the slider.

BRANCH THICKNESS

The Branch Thickness slider lets you specify a minimum and maximum percentage width for the branches, from 1 to 100. This setting doesn't control the actual width of the branches; it is the percentage width of child branches. For example, if the branch thickness is set to 50%, each child branch will be 50% of the width of the parent branch it is spawned from.

To set the maximum branch thickness:

- Drag the arrow below the Branch Thickness slider to the desired value, or type a value in the field to the right of the slider.

To set the minimum branch thickness:

- Drag the arrow above the Branch Thickness slider to the desired value, or type a value in the field to the left of the slider.

NUMBER OF SEGMENTS

Each branch of the tree is divided into a number of segments. Each segment is a location on a “parent” branch where “child” branches will be formed.

TO SET THE MAXIMUM NUMBER OF SEGMENTS:

- Drag the arrow below the Segments slider to the desired value, or type a value in the field to the right of the slider.

TO SET THE MINIMUM NUMBER OF SEGMENTS:

- Drag the arrow above the Segments slider to the desired value, or type a value in the field to the left of the slider.

BRANCHES PER SEGMENT

The Branches Per Segment slider lets you specify how many “child” branches will be formed in each branch segment.

TO SET THE MAXIMUM NUMBER OF BRANCHES PER SEGMENT:

- Drag the arrow below the Branches Per Segment slider to the desired value, or type a value in the field to the right of the slider.

TO SET THE MINIMUM NUMBER OF BRANCHES PER SEGMENT:

- Drag the arrow above the Branches Per Segment slider to the desired value, or type a value in the field to the left of the slider.

BRANCH ANGLES

The starting and ending angles for branches help determine the overall shape of a tree. The branch start angle is the angle of the branch at the thickest part of the tree. The branch end angle is the angle of the branch at the thinnest part of the tree.

TO SET THE BRANCH START ANGLE:

- Drag the Branch Start Angle slider. Drag right to increase the angle and left to decrease it.

TO SET THE BRANCH END ANGLE:

- Drag the Branch End Angle slider. Drag right to increase the angle and left to decrease it.

TRUNK AND BRANCH TEXTURE

You can use a uniform color, an image, or a material as the texture for the trunk and branches of a tree. All the branches and the trunk of the tree will have the same texture; you cannot vary the texture for the branches and the trunk.

TO USE A UNIFORM TEXTURE:

- 1 Click the Uniform button.
- 2 Click the Uniform Color swatch and choose a color from the color picker.

TO USE AN IMAGE TEXTURE:

- 1 Click the Image button.
- 2 Click the Edit button to the right of the Image button. The Picture Library appears.

Refer to “Working with Pictures” on page83 for more on the Picture Library.

TO USE A MATERIAL TEXTURE:

- 1 Click the Material button.
- 2 Click the Edit button to the right of the Material button. The Materials Lab appears.

Refer to “The Materials Lab” on page160 for more on the Materials Lab.

TREE SETTINGS

You can use the tree settings to set the overall shape of a tree, and how the tree is affected by gravity. You can set the amount of randomness for the tree, ensuring that even with the same settings,

no two trees will look alike. You can also use the Tree Lab's memory dots to store settings as you experiment with different tree attributes.

TREE SHAPE

The overall shape of a tree varies greatly for different species of trees. Using the Shape drop down list, you can choose a species of tree for the overall shape of the tree.

TO CHOOSE A TREE SHAPE:

- Click the Shape drop down list and choose a species of tree.

GRAVITY

The branches and leaves of a tree can be affected by gravity. When gravity is high, the branches of a tree will droop and the leaves will be oriented towards the ground. When gravity is low, the same branches may be more upright, and the leaves may be oriented in all directions. The Gravity slider lets you specify how much gravity will be applied to a tree.

TO SET THE GRAVITY AMOUNT:

- Drag the Gravity slider right to increase the amount of gravity and left to decrease it, or enter a value in the field.

RANDOMNESS

Trees in nature are not perfectly shaped. Two trees of the same species growing under identical conditions will vary greatly from one another. In Bryce, you can control the randomness of a tree so that, even with the identical settings, no two trees will be identical. The randomness setting affects both branch angles and leaf angles.

TO SET A VALUE FOR RANDOMNESS:

- Drag the Randomness slider right to increase the amount of randomness and left to decrease it, or enter a value in the field.

SAVING TREE LAB SETTINGS

The memory dots in the Tree Lab let you store your favorite Tree Lab settings. Using these dots you can safely explore many Tree Lab configurations without losing your favorite settings along the way. Memory dots appear at the bottom of the Tree Lab.



The memory dots in the tree lab let you store your favorite Tree Lab settings.

TO SAVE TREE LAB SETTINGS:

- In the Tree Lab, click on an empty dot (empty dots are gray).

All the current Tree Lab settings are stored in the selected dot.

TO SWITCH TO A SAVED TREE LAB SETTING:

- Click on a full dot (full dots are blue). The current settings are replaced with the settings stored in the dot.

An active dot will be blue with a white point inside it.

TO RESET TREE LAB SETTINGS TO DEFAULT:

- In the Tree Lab, click the leftmost memory dot. This dot always appears full.

TO DELETE A SAVED TREE LAB SETTING:

- Option/Alt+click on a full memory dot.

The leftmost dot cannot be cleared.

FOLIAGE SETTINGS

You can use the foliage settings to control the appearance of the leaves on a tree. Using the foliage settings, you can choose a leaf shape, size, and quantity, and determine how the leaves are distributed on the branches. You can also specify a texture for the leaves.

FOLIAGE SHAPE

The leaves of different species of trees have different shapes. The Shape setting lets you choose a leaf shape from a drop down list.

To choose a leaf shape:

- Click the Shape drop down and choose a species of tree from the list.

FOLIAGE SCALE

You can control the size of the leaves on a tree using the Scale slider. The Scale slider measures the size of the leaves as a percentage of the size of the tree.

To choose the size of leaves:

- Drag the Scale slider. Drag right to increase the scale and left to decrease it.

NUMBER OF LEAVES

The Number of Leaves slider lets you choose how many leaves will appear on each branch.

To set the number of leaves:

- Drag the Number of Leaves slider right to increase the number of leaves and left to decrease the number of leaves, or enter a value in the field.

FOLIAGE DISTRIBUTION

In nature, different species of trees have different arrangements of leaves. Some trees have leaves that are clustered together while others have leaves that spiral around a branch in an almost symmetrical pattern. Bryce offers five different leaf arrangements: Stacked, Staggered, Spiral, Bunched, and Coniferous.

To choose a leaf distribution:

- Click the button beside one of the following options:

Stacked — leaves are arranged in pairs on each side of the branch. If there is an odd number of leaves, a single leaf will be placed at the tip of the branch.



Staggered — leaves alternate on each side of the branch. If there is an odd number of leaves, a single leaf will be placed at the tip of the branch.



Spiral — leaves are arranged around the branch in a spiral formation.



Bunched — leaves are clustered at the tip of the branch.



Coniferous — leaves are placed along the middle of the branch.



FOLIAGE TEXTURE

You can use a uniform color, an image, or a material as the texture for leaves of a tree. All the leaves will have the same texture; you cannot vary the texture of leaves.

To use a uniform texture:

- 1 Click the Uniform button.

- 2 Click the Uniform Color swatch and choose a color from the color picker.

TO USE AN IMAGE TEXTURE:

- 1 Click the Image button.
- 2 Click the Edit button to the right of the Image button. The Picture Library appears.

Refer to “Working with Pictures” on page83 for more on the Picture Library.

TO USE A MATERIAL TEXTURE:

- 1 Click the Material button.
- 2 Click the Edit button to the right of the Material button. The Materials Lab appears.

You can only change the material of the leaves if you access the Materials Lab through the Tree Lab. If you select a tree and access the Materials Lab or the Materials Preset Library from the Edit palette and choose a material, the material will only be applied to the trunk and branches of the tree.

Refer to “The Materials Lab” on page160 for more on the Materials Lab.

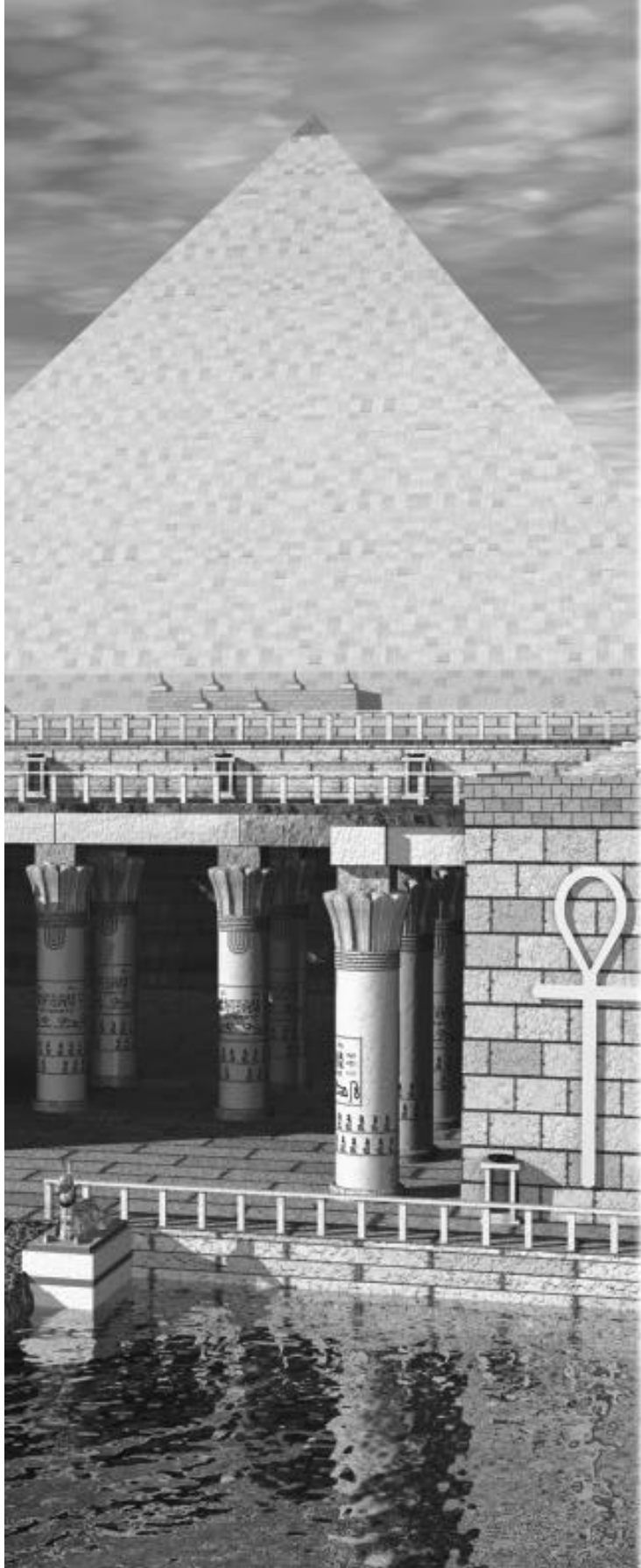

7

Applying MATERIALS

Materials are what brings your Bryce environment to life. A material defines the surface properties of an object in your scene. It has the power to turn a bunch of polygons into an island or the peaks of the Himalayas. You can also alter the basic function of an object. A simple cylinder becomes a pillar, a tree trunk or a metal pipe, just by adjusting the properties of the material applied to it.

In Bryce, a material isn't just a picture that's wrapped around an object; it's a truly 3D surface. The material properties you assign to an object are applied to the whole object—inside and out.

Bryce's new volume materials let you apply a material to the interior of the object as well as to its surface. The Volume Material controls let you set how the entire object's volume reacts to its environment.

MATERIAL STRUCTURE

A material is made up of fourteen channels. Each of these channels defines a different property of an object's surface. When you combine all the channels together you get a material.

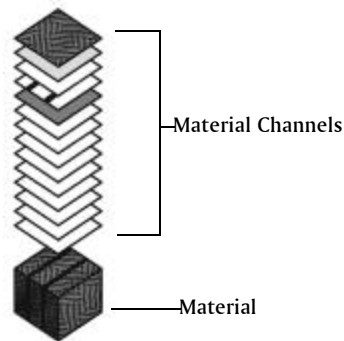

A material has fourteen channels that define its surface properties. The combination of the values of all the channels produces a material.

New materials are created by adjusting the values for each channel.

There are two types of materials you can create in Bryce: surface materials, which define the properties of an object's surface, and volume materials, which define the properties of an object's volume.

UNDERSTANDING SURFACE MATERIAL CHANNELS

The fourteen channels of a surface material each represent a different surface property. These properties simulate different physical properties of a surface, and the combination defines how the object's surface interacts with light in the Bryce environment.

To understand how the channels work, you need to understand a little about how you perceive light and color.

The color and size of an object are determined by how the light that hits the object is reflected back to your eye. Objects appear green because they reflect green light. An object appears shiny because it reflects light back at you.

An object appears transparent because light passes through its surface, hits the objects behind it and is reflected back through the surface. Bryce's material channels simulate all these behaviors. When you set a channel value, you're setting how your object's surface interacts with the light that hits it, whether that light is from a direct source like the sun, or an indirect source like light reflected off other surfaces.

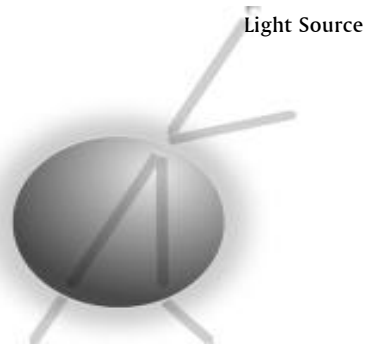

Material channels simulate the physical properties of an object. When you set channel values, you're defining how the object's surface or volume interacts with light.

When you're creating volume materials, your settings not only control how light interacts with the surface of the object, but also how it interacts with the object's volume.

The effects of the channels are additive, meaning that each value you set directly affects all the other values. So, if you set the Diffuse Color to yellow and the Ambient Color to blue, the object will have a greenish tint.

Channels are interdependent. For example, you won't see the effects of the Transparent Color if the object is not transparent.

When you're using these channels it's important to understand the physical property they're simulating. Only in this way can you make meaningful adjustments to the component values.

For example, if you set both Transparency and Reflection to 100, you'll get an unusually bright object that doesn't look very realistic. The reason for this is that the object is emitting more light than it is receiving, something it couldn't do in reality.

Since material channels simulate real-world surface properties, you should try to keep channel values within a realistic range.

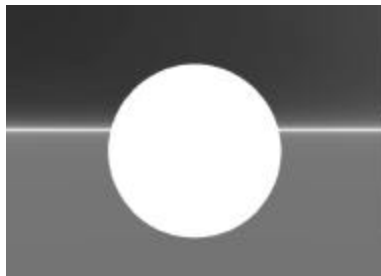

For example, here Transparency and Reflection are both set to 100. With these settings you're saying that 100% of the light that hits the object passes through its surface, and 100% of the light that hits the object is also reflected off its surface.

The result is an object that emits more light than it receives because it's reflecting the light that hits it as well as the light from behind it.

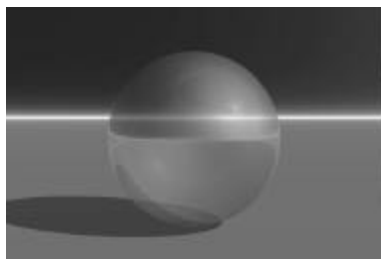

In reality, an object can only reflect a portion of the light that's passing through it. So, Transparency and Reflection values should always add up to 100.

A good rule of thumb to keep in mind while you're setting these channels is that the Transparency and Reflection channels should always add up to 100, and the Diffusion and Ambience values should also always add up to 100.

Each surface material is made up of fourteen channels, divided into three groups:

Color CHANNELS

- Diffuse Color
- Ambient Color
- Specular Color
- Transparent Color
- Specular Halo
- Volume Color

VALUE CHANNELS

- Diffusion
- Ambience
- Specularity
- Metallicity
- Bump Height

Optics CHANNELS

- Transparency
- Reflection
- Refraction

Color CHANNELS

The Color group contains all the channels that control the color reflected off an object's surface. The channels in the Color group are Diffuse Color, Ambient Color, Specular Color, Transparent Color and Volume Color.

Diffuse Color, Ambient Color, and Specular Color define the colors the surface reflects when direct light hits it. For example, Diffuse Color defines the

color that is reflected in all directions when direct light hits the object, and Specular Color is the color that appears in the object's highlight.

These color channels are directly related to the Diffusion, Ambience, and Specularity channels. Diffusion, Ambience, and Specularity control how light reflects off the object, while Diffuse Color, Ambient Color and Specular Color control the color of that light.

So, for example, if you selected yellow as the Diffuse Color, the object appears yellow. The intensity of the yellow color is controlled by the Diffusion channel. Refer to "Diffuse Color" on page 134, "Ambient Color" on page 136, and "Specular Color" on page 137 for more information.

Transparent Color sets the color of any light that passes through the surface of the object, and Specular Halo controls the size of the highlight that appears when an object has a shiny surface. Refer to "Transparent Color" on page 140 and "Specular Halo" on page 137.

The remaining color channel, Volume Color, controls the color of the interior of the object. Refer to "Volume Color" on page 142 for more information.

VALUE CHANNELS

The second group of channels, the Value group, controls how much light affects an object. The channels in the Value group are Diffusion, Ambience, Specularity, Metallicity and Bump Height.

Diffusion, Ambience, and Specularity define how the surface interacts with direct light. They let you control how much direct light affects the surface of an object. In a physical environment, these channels control how shiny, dark, or bright the object appears. Refer to "Diffusion" on page 133, "Ambience" on page 135 and "Specularity" on page 136 for more information.

Metallicity is related to Reflection. It determines how much reflected light is filtered through the Diffuse Color. Refer to "Volume Material Channels" on page 142 for more information.

Bump Height controls the height of any bumps or dents on the object's surface. Refer to "Bump Height" on page 138 for more information.

OPTICS CHANNELS

The Optics group of channels controls the intensity of optical effects produced by the object's surface. The channels in the Optics group are Transparency, Reflection and Refraction.

Transparency and Reflection channels control how indirect light interacts with the object's surface. In a physical environment, these channels control how transparent or reflective the object appears. Refer to "Transparency" on page 139 and "Reflection" on page 141 for more information.

Refraction is directly related to Transparency. The Refraction channel sets how much the light that passes through the object is bent. Refer to "Refraction" on page 141 for more information.

UNDERSTANDING VOLUME MATERIAL CHANNELS

Surface materials define the properties of the surface of an object. The interior of the object is empty. If you were to fly through the object you would see one layer of material, emptiness, and then another layer of material. A volume material is applied to the entire object, both inside and out. If you were to fly through a volume material you would be surrounded by material.



Blue spots become blue spheres when the texture is applied as a Volume Material.

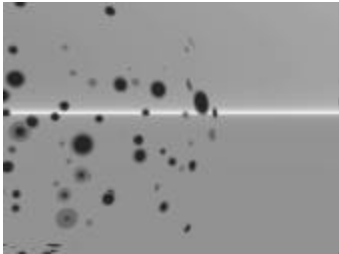

When you create a volume material, the channels define not just the surface of an object, but its volume as well.

When you're setting channel values for a volume material, you're setting up how light will interact with the object's volume. Channels control whether the interior of an object is bright, dark, shiny, or transparent.

In most cases the interior of an object will be filled with a texture. If so, the channels control the surface properties of the elements within the texture.

For example, if you apply blue spots as a volume material, you get a volume filled with blue spheres. The channels then control whether those spheres are bright, dark, shiny, or dull.

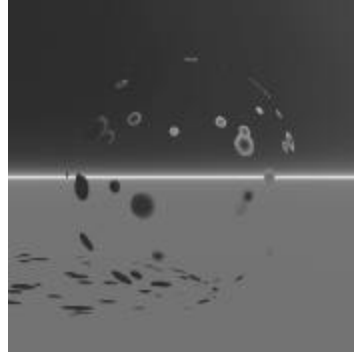

When the interior of an object is filled with a texture, the material channels control the surface properties of the elements within the texture.

In this example, the Specularity channel is used to make the blue spheres within an object shiny.

Volume materials are made up of thirteen channels, divided into three groups:

COLOR CHANNELS

- Diffuse Color
- Ambient Color
- Specular Color
- Transparent Color
- Specular Halo
- Volume Color

VALUE CHANNELS

- Diffusion
- Ambience
- Specularity

VOLUME CHANNELS

- Base Density
- Edge Softness
- Fuzzy Factor
- Quality/Speed

The channels in the Color and Value groups work exactly as they do for surface materials, except that the channel settings are applied to the object's volume instead of its surface.

VOLUME CHANNELS

The Volume channels control special volume properties of the object's interior.

Base Density controls the density of the object. This channel defines how much material there is in the interior of an object. As a result, Base Density controls how much light passes into the object. A solid object doesn't allow any light to pass through it, while less dense objects allow more light in. Refer to "Base Density" on page 143 for more.

Edge Softness, Fuzzy Factor, and Quality/Speed control the appearance of texture elements within the material. Edge Softness and Fuzzy Factor control the quality of the edges and sharpness of the texture, while Quality controls the render quality of the material. Refer to "Edge Softness" on page 143, "Fuzzy Factor" on page 143, and "Quality/Speed" on page 144 for more.

UNDERSTANDING MATERIAL COMPONENTS

Each Bryce material channel can contain up to three components that determine the channel's setting. A component can be a color, a texture or a numerical value. A texture can be either a 2D texture (picture) or a 3D texture.

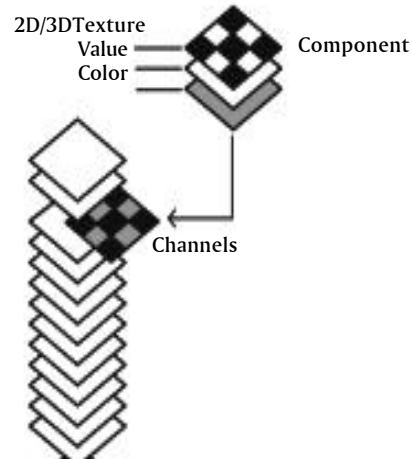

Each Bryce material channel contains components that determine its settings.

You can have up to three texture components in a channel, and some channels let you use four textures and a value as components.

Colors can only be used in the Diffuse, Ambient, Specular Transparent, Specular Halo and Volume channels. Values are used in the Diffusion, Ambience, Specularity, Metallicity, Bump Height, Transparency, Reflection, Refraction, Base Density, Edge Softness, Fuzzy Factor, and Quality/Speed channels.

When you're using a texture as a component, the information in the texture's channels is used as the value of the material channel. For example, if you're using a texture to set Diffuse Color, the texture's color channel is used. If you're using a texture to set the Diffusion value, the texture's alpha channel determines the Diffusion intensity.

Components are combined using one of three modes: Mode A, Mode AB and Mode ABC. In Mode A, only one component is used to set the channel's value. In Mode AB, two components are combined to set the channel's value, based on altitudes. The values from texture A are applied at low altitude and values from texture B are applied at higher altitude.

In Mode ABC, the values of two textures, A and B, are blended based on the alpha channel of texture C.

When you're using textures as a component, you can choose from a number of preset textures, or you can open the Texture Editor and create your own textures. Refer to "Combining Components" on page 154 for more information.

In some channels, you can use both a texture and a value. In this case, the value determines how much of the texture's value is used to drive the channel. For example if you apply a Blue Checkers texture to the Bump Height channel, the texture sets the shape of the bumps and the value sets how prominent those bumps appear.

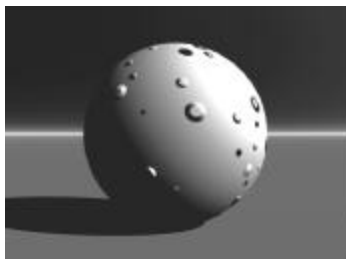

In this example the shape of the bumps on the object is set by the texture component in the Bump Height channel, but the height of those bumps is set by a value.

A WORD ABOUT ALPHA CHANNELS

One of the outputs a texture component can produce is an alpha channel. The alpha channel is a grayscale representation of the texture pattern or grain. When you use a texture as a component in a material channel, these grayscale values are used to map surface properties. White areas in the alpha channel represent 100% of the effect, and black areas represent 0%.

Images, or 2D textures, also contain an alpha channel. In images, the alpha channel acts as a mask for the image. The image's alpha channel is used in the same way as a texture's alpha channel.

SURFACE MATERIAL CHANNELS

This section provides details on each of the surface material channels.

Diffusion

Diffusion determines how much direct light is reflected diffusely, or scattered, in all directions.

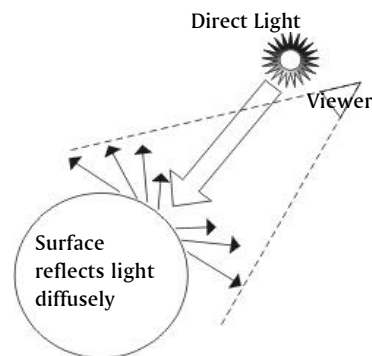

The small arrows projecting off the surface of the object illustrate how diffusion works.

When light hits an object with diffusion set to 100%, all the light that hits it is reflected back scattered in all directions. This gives the object a flatly lit appearance. If the object's diffusion is set to 0%, no light is reflected off its surface, so the object appears black.

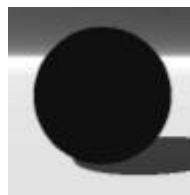

Diffusion set to 0%

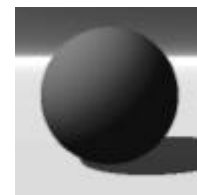

Diffusion set to 100%

Diffusion controls how much light is diffusely reflected off the object's surface.

SETTING DIFFUSION USING A TEXTURE

When you assign a texture to the Diffusion channel, the texture's alpha channel determines which areas of the surface have high diffusion and which have low diffusion. Bright areas in the alpha channel have a high diffusion value, and darker areas have low diffusion values.

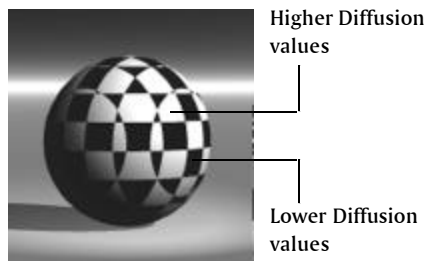

Alpha Channel

When you use a texture to set the Diffusion channel, the grayscale values in the texture's alpha channel determine the diffusion of the objects.

DIFFUSE COLOR

Diffuse Color acts like a filter through which all diffuse light passes. When light hits the object, the amount of light that's reflected diffusely is determined by the Diffusion channel setting, and the color of that light is set by the Diffuse Color channel.

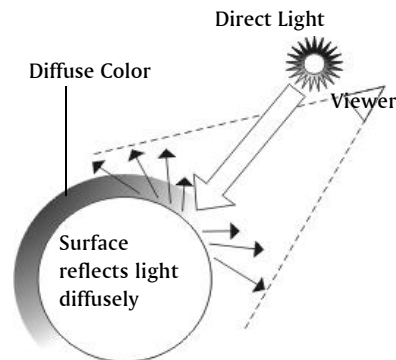

This graphic shows how diffuse light passes through the Diffuse Color.

When Diffusion is set to a value greater than zero, the Diffuse Color appears wherever the object is hit by direct light.

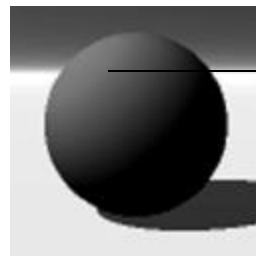

Diffuse Color is the color of diffusely reflected light.

Be careful when using pure constant colors as the Diffuse Color because you may not get the results you're expecting. If you use a pure color, only that color is reflected off the object. So if you're using 100% green, only green light is reflected off the surface. This doesn't cause a problem when the object is hit by white light because there is green in white. However, if you use 100% red light on the object, it will appear black, since there is no green in 100% red, so no light is reflected off the object.

AMBIENCE

Ambience simulates the effects of light hitting the object from all directions. The Ambience value controls the amount of light that is reflected off the surface uniformly.

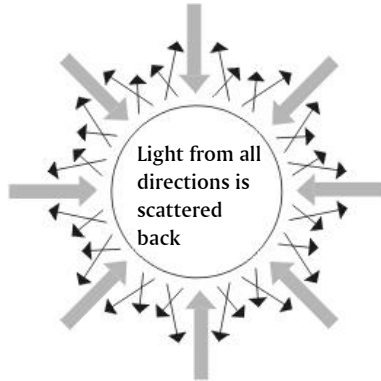

The large arrows represent ambient light hitting the object's surface. The smaller arrows represent the light reflected off the object's surface.

When Ambience is set to a value higher than zero, the object will reflect light from all over its surface, not only from the area hit by light. This makes the object look brighter.

The higher the Ambience value, the brighter an object appears. At 100%, the object appears unnaturally bright, regardless of the light source. If you want to create a realistic effect, the sum of the Ambience and Diffusion values should add up to 100.

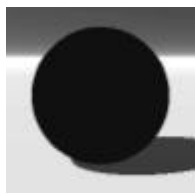

Ambience set to 0%

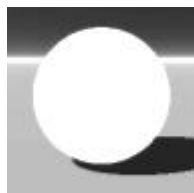

Ambience set to 100%

Ambience controls the general brightness of an object.

An object's ambience is directly related to the general ambience of the environment. So, the ambient value you set for the object is directly affected by the Ambient Color you set in the Sky & Fog palette.

The Ambient Color in the Sky & Fog palette controls how much ambient light is available in the environment. The Ambience channel controls how much of the available ambient light is reflected off the object's surface.

So, if you set the Ambient Color in the Sky & Fog palette to black, or 0% ambience, then the Ambience channel value has no effect. If you set the Ambient Color to white, or 100% ambience, the Ambience channel value will control how much of the available light is reflected off the object's surface.

SETTING AMBIENCE USING A TEXTURE

When you assign a texture to the Ambience channel, the grayscale values from the texture's alpha channel determine which areas of the surface have high ambience and which have low ambience. Bright areas in the alpha channel have high ambience values, and darker areas have low ambience values.

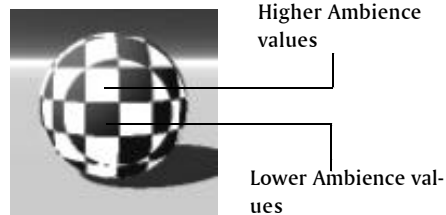

When you use a texture to set the Ambience channel's value, the values are determined by the grayscale values in the texture's alpha channel.

Generally, it's best to set Ambience using a value. However, you can get some interesting effects using textures instead. For example, if you use a

splotchy texture, you'll get, mixed in with normal surface areas, areas that appear to glow regardless of external light.

AMBIENT COLOR

Ambient Color is the color that is reflected off the surface of an object regardless of where the light source hits the object. The Ambient Color is directly linked to the Ambience channel setting. If the Ambience is set to zero, the Ambient Color is invisible.

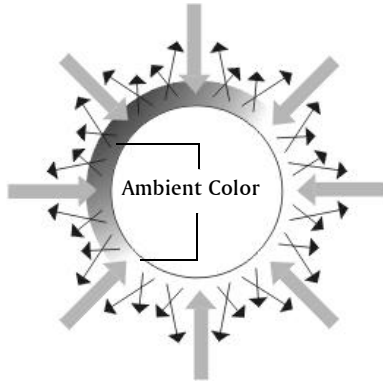

Ambient Color is the color that reflects off the entire surface of the object and is directly related to Ambience.

The Ambient Color tints the entire surface of the image.

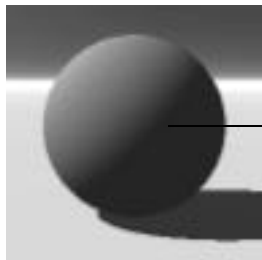

Ambient Color tints the entire surface

Ambient Color is the color that appears no matter where light strikes the object.

The Ambient Color channel is also related to the ambient color you set in the Sky&Fog palette. The ambient color of the environment is added to the

ambient color of the object, so if your environment is blue and your object's ambient color is yellow, your object appears green.

SETTING AMBIENT COLOR USING A TEXTURE

When you assign a texture to the Ambient Color channel, the color channel in the texture is used as the Ambient Color. In other words, the texture's color is applied to any area of the object that's in shadow.

SPECULARITY

Specularity controls how much light is reflected back from the surface of the object directly at the viewer.

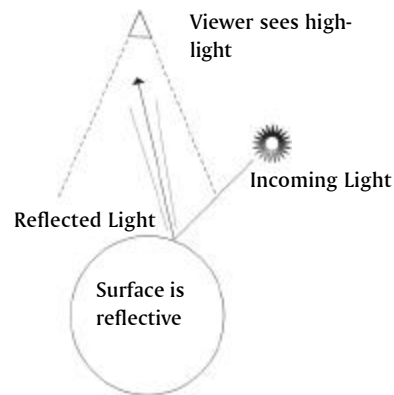

Specularity is the highlight reflected directly back at the viewer.

Since the direct reflection creates a highlight on the object, you can think of Specularity as the channel that determines the intensity of the highlight that appears on the object, or the "shininess" of the object.

The higher you set the Specularity, the shinier the object appears. When the Specularity is set to zero, the object appears dull.

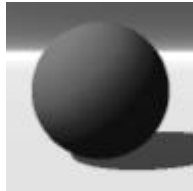

Specularity set to 0%

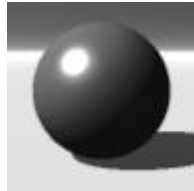

Specularity set to 100%

Specularity controls the intensity of the highlight of an object.

SETTING SPECULARITY USING A TEXTURE

When you assign a texture to the Specularity channel, the grayscale values in a texture's alpha channel are applied to the object's highlight. Bright areas of the alpha channel increase the intensity of the highlight, and darker areas decrease the intensity. The alpha channel may also create patterns in the highlight.

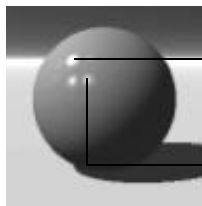

High Specularity values

Lower Specularity values



Alpha Channel

When you use a texture to set the Specularity channel's value, the highlight's intensity is determined by the texture's alpha channel values.

SPECULAR COLOR

Normally, the color of an object's highlight would reflect the color of the light source. However, using Specular Color you can set a specific color for your highlight.

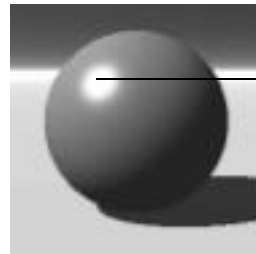

Specular Color applied to object's highlight

Specular Color is the color of the object's highlight.

Specular Color is directly linked to the Specularity channel. If the Specularity is set to zero, the Specular Color is invisible.

By adding Specular Color, you can make it appear as though a colored light is shining on the object.

SETTING SPECULAR COLOR USING A TEXTURE

When you assign a texture to the Specular Color channel, the texture's color channel is used as the Specular Color. In other words, the texture's color is applied to the object's highlight.

SPECULAR HALO

The Specular Halo channel lets you control the size of the Specular highlight.

The size is controlled by the luminance value of the component you select. Brighter colors create larger highlights and darker colors create smaller highlights.



Specular Halo set using bright colors

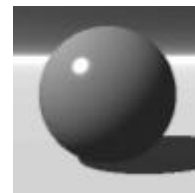

Specular Halo set using dark colors

Specular Halo controls the size of the highlight on your object.

Colors are expressed as RGB (Red, Green, and Blue) values. Specular Halo channels use the values from each of these channels to set the size of the highlight. If the values are all in balance (that is, all the same), the highlight appears uniform. However, if one value is higher than the rest (for example, R=200, G=100, B=100), you'll get a highlight with a slightly colored ring (for example, a red ring).

Depending on the component you use in this channel, you may be able to set each color value differently to create different highlight effects. The easiest way to use this channel is with a color.

When using a color, try picking more desaturated colors. These colors produce more predictable results because the difference between RGB values is less.

Check out the Specularity Lesson series in the Fast & Simple category in the Preset Materials Library to see Specular Halo in action.

SETTING SPECULAR HALO USING A TEXTURE

When you assign a texture to the Specular Halo channel, the RGB value of the texture's color channel is used for the Specular Halo.

METALLICITY

The Metallicity channel value acts as a filter for reflected light. This value controls how much of the reflected light is filtered through the Diffuse Color.

At 50%, half the reflected light is tinted with the Diffuse Color; at 100%, all the light that's reflected is tinted.

Metallicity is linked to Reflection. If Reflection is set to zero, the Metallicity channel has no effect.

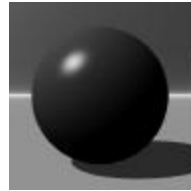

Metallicity set to 50%

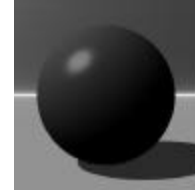

Metallicity set to 100%

Metallicity controls how much of the reflected light is tinted with the Diffuse Color.

Metallicity makes objects look metallic because it tints the color of reflections. If you want to create specific types of metals, you need to adjust the Diffuse Color. For example, to create gold use a yellow Diffuse color.

SETTING METALLICITY USING A TEXTURE

When you apply a texture to the Metallicity channel, the texture's alpha channel is used to determine the intensity of the Diffuse Color. Lighter areas of the alpha channel increase the intensity of the color, and darker areas decrease the intensity.

BUMP HEIGHT

The Bump Height controls the height of bumps in an object's surface. The bumps on an object's surface are determined by the texture's Bump channel. The Bump Height channel is linked to the Bump channel in the texture. If you use a texture without a Bump channel, the Bump Height channel has no effect. You can enter negative values in this channel, which turns bumps into dents.



Bump Height set to -100%

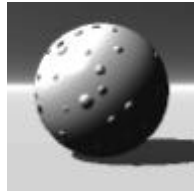

Bump Height set to +100%

Bump Height controls the height of bumps on the surface of your object.

TRANSPARENCY

The Transparency channel controls how much light can pass through the object's surface.

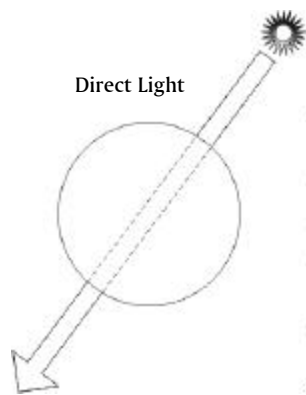

The amount of light that can pass through an object's surface is set with the Transparency channel.

The higher the Transparency value, the more of the surrounding environment is visible through the object's surface. If there is no other light being reflected, an object set at 100% Transparency appears invisible.



Transparency set to 0%



Transparency set to 100%

Transparency controls how much of the surrounding environment is visible through the object's surface.

To create a realistic transparent object, you need to pay attention to details. You'll need to combine the effects of the other channels to simulate a realistic object. For example, transparent bubbles all have highlights, so you'll need to add Specularity. Balloons have a flatter surface so you'll need to add more Diffusion to the surface. Glass has a refraction effect associated to it, so you'll need to add Refraction to the surface.

SETTING TRANSPARENCY USING A TEXTURE

When you apply a texture to the Transparency channel, the texture's alpha channel is used to determine which areas of the object are transparent. Lighter areas of the alpha channel are not transparent while darker areas are.

You can create some interesting effects using textures. For instance, a checkerboard texture will result in an object that's alternately transparent and solid.

The final look of the Transparency channel is determined by the Shading mode. When the material is applied using normal shading, Transparency creates an optical effect.

When the material is applied using Blend Transparency mode, Transparency creates a punch-out effect. The areas of the surface that are 100% transparent are completely ignored during shading so that they appear as gaps or holes in the surface. Any areas that are less than a 100% result in a normal transparency effect.

Refer to “Shading Modes” on page 155 for more on Shading modes.

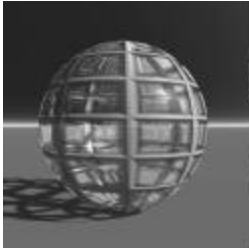

Cage texture applied to Transparency channel

You can create some interesting effects using textures in the Transparency channel, like this checkerboard object. This example was created using regular shading.

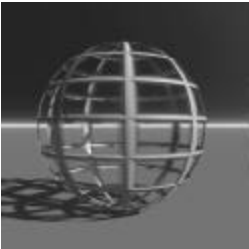

This is what the same material looks like when you use Blend Transparency.

TRANSPARENT COLOR

The Transparent Color channel determines the color of the transparent areas of your object. Light is filtered through this color as it passes through the object’s surface. As a result, anything you can see through your object is tinted with the Transparent Color you select.

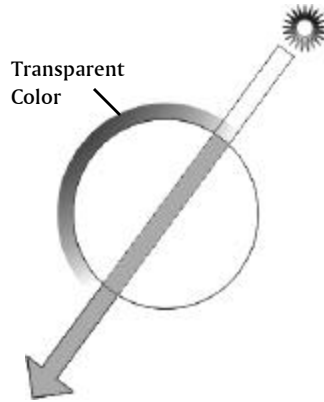

Transparent Color tints any light that passes through the object.

Keep in mind that the Transparent Color interacts with the other colors in the material. If the Diffuse Color is white, then the Transparent Color takes precedence. If the Diffuse color is yellow, and the Transparent color is red, the object appears orange. However, when you’re using Refraction, the Transparent Color blends with the Diffuse Color.



Transparent Color applied to the object

The Transparent color tints everything you see through the surface of your object.

Transparent Color is linked to the Transparency channel. If the Transparency is set to zero, the Transparent Color is invisible.

SETTING TRANSPARENT COLOR USING A TEXTURE

When you assign a texture to the Transparent Color channel, the texture’s color channel is applied to the transparent areas of your object.

REFRACTION

The Refraction channel determines whether light bends when it passes through the surface of an object.

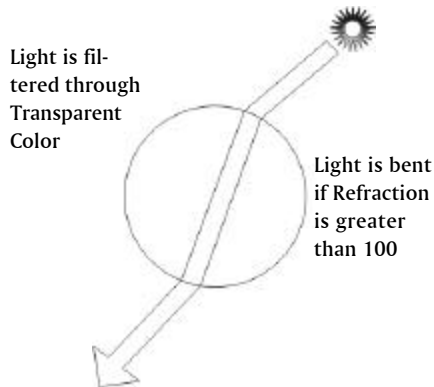

Light may bend as it passes through an object, depending on the Refraction value.

Higher Refraction settings produce slight reflections as some of the light is bent directly back at its source. Higher Refraction settings also change the color of the object's surface as the colors reflected from the environment affect the object's color.

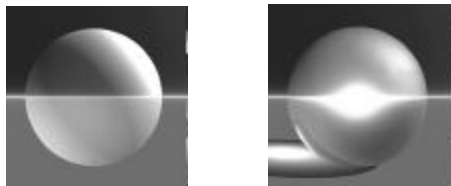

Refraction set to 0

Refraction set to 116

Refraction controls how much light bends as it passes through a transparent surface.

The Refraction value is what makes transparent surfaces look like glass.

As you increase the Refraction value, the edges of the object will become reflective. This simulates the effect of light being refracted so sharply that it does not penetrate the object's surface.

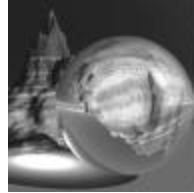

Refraction set to 140

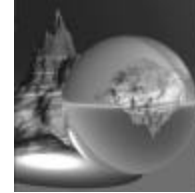

Refraction set to 300

In these examples you can see how the edges become more reflective as you increase the Refraction value.

The higher you increase the Refraction value, the more the Diffuse Color is blended with the Transparent Color. The higher the value, the more Diffuse Color is visible in the object's surface. Any light that's visible through the surface of the object is then tinted through both the Diffuse Color and the Transparent Color.

Refraction values are expressed as 100 x Refraction Index value. The Refraction Index contains refraction values for specific types of surfaces. For example, the Refraction Index of water is 1.3; this value is expressed as 130 in the Materials Lab.

Refraction is linked to Transparency. If Transparency is set to zero, this channel has no effect.

REFLECTION

The Reflection channel controls how much light, direct or indirect, is reflected off the object's surface. Unlike diffusion, which scatters light, reflection directs light back at its source, giving the object a mirrorlike appearance.

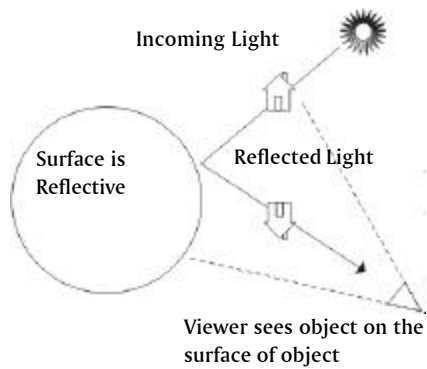

Reflection determines how much light is reflected off the surface of the object.

The higher the Reflection setting, the more reflective the surface. At 50%, half the light that hits the object's surface is reflected; at 100% all light is reflected.

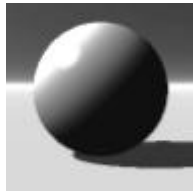

Reflection set to 50%



Reflection set to 100%

Reflection controls how much light is reflected off the surface of an object.

As you increase the Reflection value, the color of the object changes, since you can see more of the environment in the object's surface.

SETTING REFLECTION USING A TEXTURE

When you apply a texture to the Reflection channel, the texture's alpha channel is used to determine which areas of the object are reflective. Lighter areas of the alpha channel are reflective, while darker areas are not.

VOLUME MATERIAL CHANNELS

Volume materials use most of the same channels as surface materials. These channels all work the same as they do for surface materials. The only difference is that the channels control the properties of the object's volume, not its surface.

In addition to the channels already discussed, Volume materials have several specialized channels.

VOLUME COLOR

The Volume Color channel controls the color applied to the interior of an object. Everything inside the object will appear tinted with this color as all light is filtered through the Volume Color.

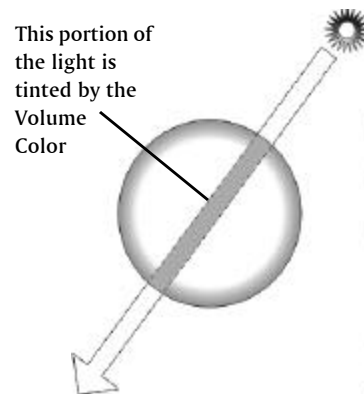

The interior of an object can have color, which you set with Volume Color.

The Volume Color interacts with the Transparent Color. If your surface is transparent, light is tinted by the Transparent Color and the Volume Color.

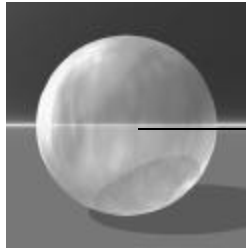

Volume Color applied to the interior of the object

The Volume color tints everything inside the object.

Volume color is an excellent way of creating underwater light effects.

BASE DENSITY

Base Density controls how dense the object is. In areas where the object is very dense, no light passes through the object. Where the object is less dense, more light passes through its volume. Base Density works like Transparency in 3D space. Areas that are less dense appear to be more transparent.

High values create very solid objects like rocks, while lower settings create less dense objects like clouds.

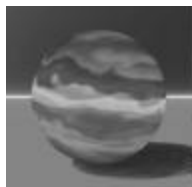

Base Density set to 100

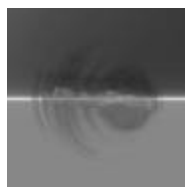

Base Density set to 0

Base Density controls the density of the area within an object. Objects with a low density will appear more transparent.

You should use this channel cautiously. The more transparent objects are, the more time they take to render.

SETTING BASE DENSITY USING A TEXTURE

When you use a texture to set this channel, the alpha channel is used to determine which areas of the object are solid and which are empty.

EDGE SOFTNESS

Edge Softness controls the softness of the edges of the silhouettes of objects with a volume material. For example, a sphere with a low Edge Softness value will have a “hard” silhouette, meaning that you’ll be able to clearly see the edges of the sphere. A high Edge Softness value will almost totally obscure the edges of the sphere.



Edge Softness set to 0

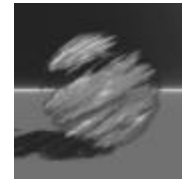

Edge Softness set to 100

Edge Softness controls the softness of an object’s silhouette.

This channel is useful for obscuring the general shape of an object.

FUZZY FACTOR

Fuzzy Factor controls the dullness or sharpness of a material. Values greater than 100 adjust the dullness of the material, and values less than 100 adjust the sharpness of a material. At 100 there is no dullness or sharpness applied.



Fuzzy Factor set to 0

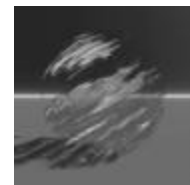

Fuzzy Factor set to 200

Fuzzy Factor controls dullness/sharpness of the texture within your object.

As you increase the dullness of your object, it becomes less dense, so you may have to increase the Base Density to compensate. Likewise, as you increase the sharpness of the object it becomes more dense.

You can use this channel to smooth sharp-looking clouds, or sharpen dull stone textures.

Quality/Speed

Quality/Speed controls the render quality of the texture. This channel represents the inverse relationship between render quality and rendering speed. As you increase the render quality of the material, you decrease the speed at which it's rendered. As you increase the speed at which a material is rendered, you decrease its quality.

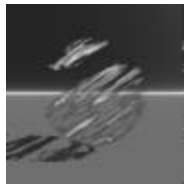

Quality/Speed set to 0

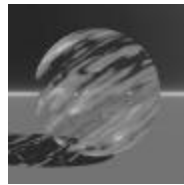

Quality/Speed set to 100

The Quality/Speed value controls the quality of the texture's render in relation to how fast it renders.

The material loses detail as the quality decreases. Detail is introduced as quality increases.

For still images you probably want to increase the quality of the material and sacrifice speed, since the scene only has to be rendered once. For animations, you probably want to sacrifice quality since the scene will have to be rendered once for each frame in the movie.

MATERIAL COMPONENTS

This section describes the various components you can use to set a material channel value. It also describes how to set the parameters for each component.

Color Components

A color component is an RGB color that is directly applied to a channel. Colors can only be used in the Color channels: Diffuse, Ambient, Specular, Specular Halo, and Volume.

When you're using a color in these channels you cannot combine it with a texture. If you choose a texture component for any of the Color channels, the color oval appears blank. The Volume channel can only be set with a color.

To use a color as a component:

- 1 In the Materials Lab, click the color oval in one of the channel rows on the Material Grid and choose a color from the palette.
 - To choose a color using the Color Picker, hold down Option/Alt when you click the color oval.

The selected color appears in the color oval. If you click on one of the columns, the color oval appears blank.

VALUE COMPONENTS

Value components are numerical values you use to set the intensity of a channel. Values can only be used in the Value, Optics or Volume channels.

A value is indicated by either the numerical field in the left side of the channel in the Material Grid, or the slider that extends out from the channel. The sliders let you quickly set the value of a channel, and the numeric field shows the current setting.



The value slider in a channel lets you set a numerical value for the intensity of the channel and displays the channel's current setting.

Values can be used with textures. In this case the value sets how much of the texture is applied to the channel. For example, if you use an orange-colored texture to set the Diffuse Color channel, the value would indicate how much of the texture color is used as the Diffuse Color.

A value of 100 means that all the texture information is used in the channel; a value of 0 means that none of the texture is used.

Not all channels use values. The Color channels only use colors or textures. The Refraction channel can only be set with a value.

To use a value as a component:

- In the Materials Lab, drag the slider next to the channel whose value you want to set. As you drag, the numerical value appears in the number field.
Some channels let you set negative values.

TEXTURE COMPONENTS

When you use a texture as a component, Bryce extracts values from the texture to use as a value for the material channel. There are two types of texture components you can use: pictures and 3D textures. Pictures are images you import from either the Picture Library or from another application. 3D textures are procedural textures generated by Bryce and stored in a texture library.

You can assign up to four textures as components for a material. These textures can be any combination of pictures and 3D textures.

Each texture component is assigned a letter: A, B, C, or D. The texture you assign to a component is used throughout the material, so the texture you assign as component A in the Diffusion channel is the same component A used in the Ambience channel and so on.

When you're setting channel values, you can mix and match components. For example, you can assign component A to Diffusion and component D to Ambience. You can also combine textures within the same channel using the blend modes AB and ABC. In this case the texture you assigned to A is blended with the textures assigned to B and C to set a material channel value. Refer to "Combining Components" on page 154 for more on blend modes.

THE TEXTURE COMPONENT WINDOW

The Texture Component window displays the attributes of a selected texture component. You can have up to four windows visible in the Materials Lab.

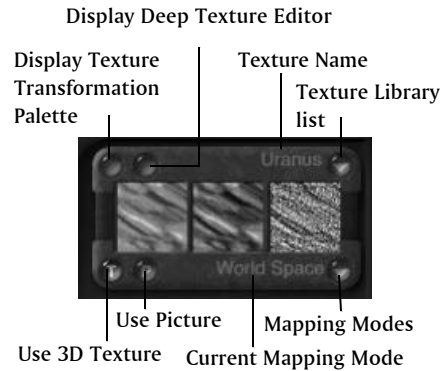

The Component window displays the selected component and its current attributes.

The six buttons on the Texture Component window let you set the type of component, the texture mapping mode, and access the texture transformation controls and the Deep Texture Editor.

To use a texture as a component:

- Click a column in the material grid. A Texture Component window appears.
The component window corresponds to the columns in the grid, so if you click column A in the grid, texture component A becomes active.

3D TEXTURES

3D textures have three different types of outputs: Color, Alpha channel, and Bump. These outputs are used differently by the material channels.

Color channels use the texture's color to set the value of the channel. For example, if you use a texture in the Diffuse channel, the colors in the texture appear wherever the object reflects light diffusely.



Diffuse color set using a color

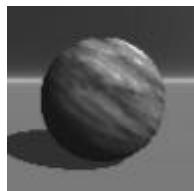

Diffuse color set using a texture

When you use a texture to set the value of a Color channel, the color information is used to set the material channel value. In this example, the Diffuse color was set using a texture.

Value, Optics, and Volume channels use the alpha channel information from a texture to set the value of the material channel. For example, when you use a texture to set Specularity, the texture's alpha channel information determines which areas of the object are shiny. As a result, you'll see the pattern of the texture on the object.

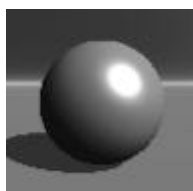

Specularity set using a value

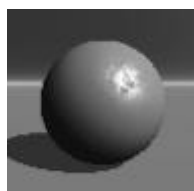

Specularity set using a texture

When you use a texture to set the value of an Intensity channel, the alpha channel information is used to set the material channel value. In this example, Specularity was set using a texture.

The Bump information in a 3D texture is used only by the Bump Height channel. The Bump channel in the texture determines the pattern of bumps or dents in the object. In fact, you won't be able to see the effects of the Bump Height value unless you assign a texture to the channel.

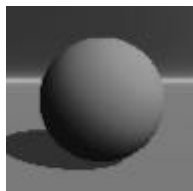

Bump Height set using a value

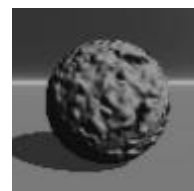

Bump Height set using a texture

Bump channel information from a texture is used to determine the pattern of bumps or dents in an object. You must assign a texture to the Bump Height channel to see the bumps or dents.

TO USE A 3D TEXTURE AS A COMPONENT:

- 1 In the Materials Lab, click a channel column. A randomly selected texture appears in the Component window.
- 2 If you want to change this texture, click the triangle button next to the texture name at the top of the window and choose a preset texture from the menu. The texture you selected appears in the Component window.

2D TEXTURES

2D textures are pictures you've created in another application or ones you select from the Pictures Library. The data in the channels of these pictures are used as values in the material channels.

TO USE A 2D TEXTURE AS A COMPONENT:

- 1 In the Materials Lab, click a channel column. A texture appears in the texture component window.
- 2 In the Component window, click the P button at the bottom of the Component window.



The P button changes the component to a 2D picture.

A default picture appears in the Component window.

- To change the picture, click the pink button at the top of the component window.



The pink button displays the Pictures Library.

The Pictures Library appears.

- Click an image square to load an image.
 - If the image you want is not in the library:
 - Click the Load text button. The Load Image dialog appears.
 - Use the dialog controls to locate the picture you want to use and click Open.
- or
- In another application, copy the picture you want to use to the Clipboard.
 - Access the Picture dialog and click the Paste text button.

The picture is loaded into the first image box and its alpha channels are loaded into the second box.

You can invert the alpha channel by clicking the invert button.



- Click the OK icon to exit the dialog.
The picture appears in the Component window.

Using the Pictures Editor

The Pictures Editor in Bryce, also known as the Picture Library, has three square previews at the top of the window. These three previews represent one image three different ways. The left image is the RGB information of the image, the middle one

is the alpha channel, the right one is the combined image. You can apply filters to each of the three parts independently.

How to select a plug-in folder:

- Click on the triangle to the right of the desired preview type.
If a plug-ins folder has been previously selected, a pull-down menu appears that displays the available Photoshop filters.
- If, for some reason, the Photoshop filters cannot be found, or you wish to select a new plug-ins folder, select Select Plug-ins Folder at the bottom of the menu.
Select a folder for the plug-in.

How to add blank images into the library:

- Load an image into the library and click on the New button at the upper right of the Pictures Editor.
The New Image dialog appears.
- Enter a name for the image as well as the image size and default color.
- Click the checkmark to return to the Pictures Editor.
The Pictures Editor will contain the new image in one of the tiles.

Once the picture is available in your library, you can load different alpha channels or different RGB information. You can also run any Photoshop filter on either of the two components of this image or on the entire image.

How to apply filters to pictures:

- Select a picture from the picture tiles.
The picture appears in the top preview frames of the picture editor.
- Select a plug-in from the currently selected plug-in folder.
- The filter is applied to your image.

TEXTURE MAPPING MODES

Once you've decided on a texture to use as a component, you need to decide how the texture is mapped onto your object. The appearance of the texture can change dramatically depending on how it's applied to the object.

Each texture you apply can have a different mapping mode. When you're mixing textures (Mode AB or Mode ABC), you can choose which portions of your textures you want to combine.

TO SELECT A MAPPING MODE FOR A TEXTURE:

- 1 In the Materials Composer, click a channel.
- 2 Select a mode for the channel.
- 3 Click the title of the Component window and choose either 2D Texture or 3DTexture.
- 4 Click the current Mapping Mode title and choose a mapping mode from the menu.

OBJECT SPACE

In this mapping mode, textures are scaled proportionally to the size of your object. If you change the size of your object, the texture scale changes with it. The texture also rotates along with the object. This means that the texture does not appear to move as you reposition or rotate the object.

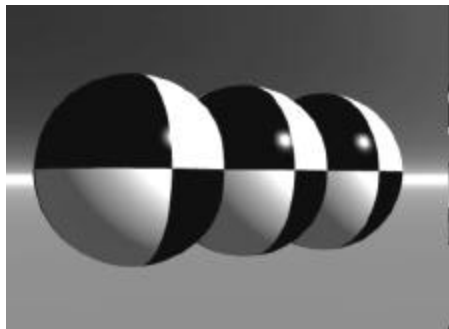

In Object Space mode, textures are applied to the object so the texture will not move as you move the object.

World Space

In this mode, the texture is applied throughout infinitely large 3D space, and only a small portion is applied to your object. This means that the texture appears to change as you move your object, since the object is moving through the texture in 3D space.

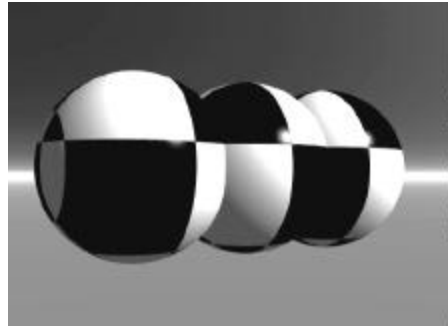

In World Space mode, the texture is applied to the entire world, so the texture appears to move as you move the object.

PARAMETRIC

In this mode, the texture is applied onto the object as if it were a decal. For example, if you use this mapping mode on a cube, one iteration of the texture is placed on each face.

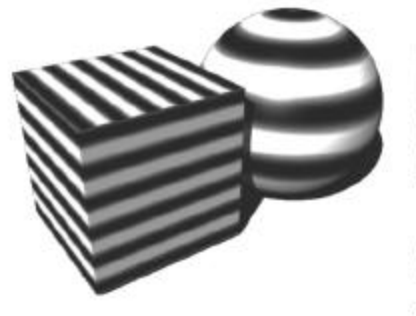

Parametric mode applies the texture as a 2D decal.

The texture is mapped onto the object so it rotates and scales as the object is scaled or rotated.

This mode works best with 2D Pict textures.

PARAMETRIC SCALED

This mode works like the World Space mode, only in 2D. Textures mapped using this mode are not scaled with the object.

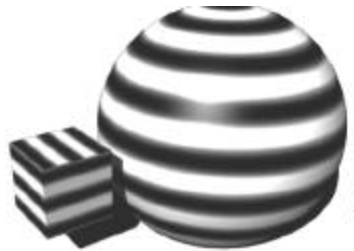

Parametric Scaled mode applies the texture as a decal, but does not scale the texture as you scale the object.

Use this mode when you want to map a 2D picture onto constructed objects like buildings.

World Top

In this mode a 2D projection of the texture is applied to the object from directly above it. If you move your object or rotate it, the texture does not move with the object; it remains constant while the object moves through it.

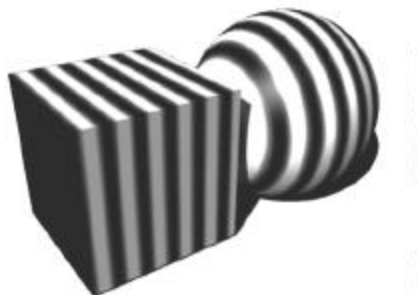

World Top mode applies the texture to the top of the world. The texture appears as a projection on top of the object and streaks down its sides.

SPHERICAL

In this mode, a 2D projection of your texture is mapped onto a virtual sphere that surrounds your object. It is then projected from the sphere onto your object.

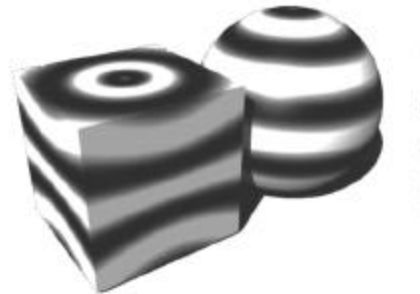

Spherical mode applies the texture to a virtual sphere and then projects it onto your object.

CYLINDRICAL

In this mode, your texture is mapped onto the front of your object, wrapping around the right and left sides all the way to the back. Edge pixels going to the center appear on the top and bottom of your object.

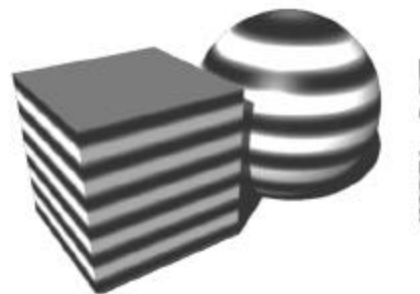

Cylindrical mode wraps a texture around the object starting from the front.

REFLECTION MAP

In this mode, a 2D projection of your texture is applied to a virtual sphere that surrounds your scene. The texture is then reflected off of the sphere and onto your object.

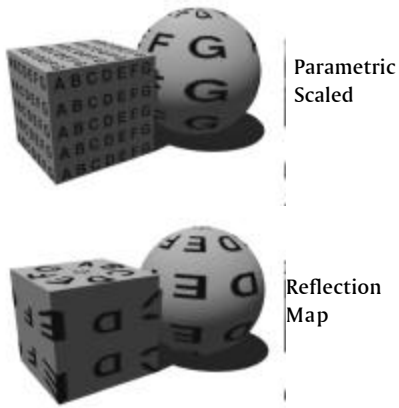

Reflection Map mode applies a reverse image of your texture to your object.

This mode works best on objects with irregular surfaces. It also works well with terrains.

RANDOM

This mode randomly applies a 2D projection of the texture all over the surface of your object.



Random mode applies the texture all over the object in a random pattern.

OBJECT TOP

This mode applies a 2D projection of the texture to the top of your object. The texture rotates and scales along with the object.

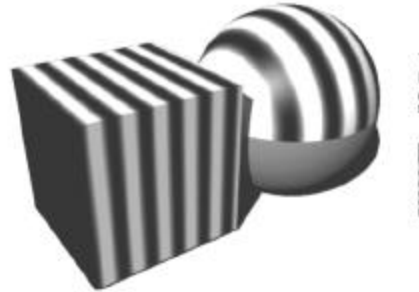

Object Top mode applies the texture to the top of the object.

OBJECT FRONT

This mode applies a 2D projection of the texture to the front of your object. The texture rotates and scales along with the object.

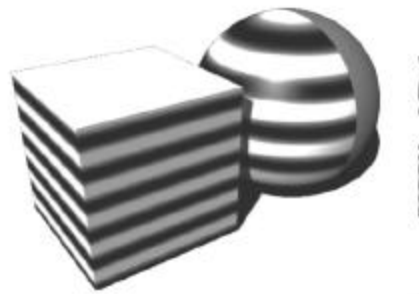

Object Front mode applies the texture to the front of the object.

MAPPING MODE MODIFIERS

You can modify the mapping modes in the following ways.

SYMMETRIC TILING

When you tile a texture onto an object in symmetrical tiling mode, each repeated instance of your texture is tiled horizontally and vertically, as needed to seamlessly produce a symmetrical pattern over the surface of the object.

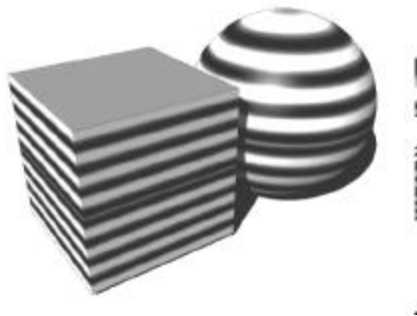

In Symmetrical Tiling mode, textures are seamlessly tiled across the object.

REPEAT TILING

Unlike symmetrical tiling, in which a seamless tiled pattern is achieved by flipping the texture horizontally and vertically, Repeat Tiling repeats your texture across the surface of your object without any alteration in orientation. The number of instances of the texture depends on the scale applied to the texture.

SCALE PICT SIZE

This mode modifier only affects picture textures. When selected, the image behaves like a sticker placed on the surface of the textured object. Unless Scale Pict Size is selected, the picture will repeat itself across the surface in a similar way to Repeat Tiling.

CENTERED TRANSFORMS

Centered transforms works with parametric mapping modes to force the transformation of the textures to be applied around the center of the object surface.

DECAL COLORS

Decal colors blends the color of a texture with the affected component's base color. It uses the texture's alpha channel to control the amount of blending. This can make decalomania effects easier to achieve.

ALPHA SCALING

Normally, if you drive a component's value with a texture, the texture's alpha channel will set the value without regard to the amount that was set using the component's slider. With alpha scaling turned on, the amount set with the slider will "scale" the amount provided by the texture's alpha channel. This gives you more subtle control over the influence of the texture on the material component's value.

PICT INTERPOLATION

This mode modifier is enabled by default. It interpolates the pict file you are using, allowing the pict file to be applied smoothly to an object. With Pict Interpolation disabled, the image may appear to be pixelated or jagged.

TRANSFORMING TEXTURES

Since a 3D texture exists in three-dimensional space, it can be transformed along the X, Y, or Z axis—just like a 3D object. Using the texture transformation tools, you can scale, position, or rotate your texture.

The final look of the transformation depends on the mapping mode you use to apply the texture to the object. In some modes, texture transformations

may not be very noticeable, while in others, like Parametric, transforms can have a large impact on the look of the material.

You may find it necessary to experiment with different settings to get the results you want. If you find that the texture isn't reacting the way you want it to, try changing the mapping mode. Refer to "Texture Mapping Modes" on page 148 for more on mapping modes.

The transformation tools give you very fine control over the final appearance of the texture.

SCALE

Using the Scale control, you can control the frequency of the texture. Increasing the scale of a texture decreases the frequency of the pattern, since it doesn't have to be repeated as many times to cover the surface of the object.

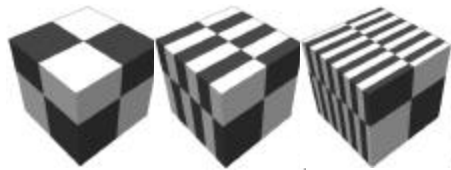

Scale X=0% Scale X= 50% Scale X=100%

Since a 3D texture exists in 3D space, you can change its size in all three axes. Adjusting the scale in X changes the size of the texture along the X axis.



Scale Y=0% Scale Y= 50% Scale Y=100%

Adjusting the scale in Y changes the size of the texture along the Y axis.



Scale Z=0% Scale Z= 50% Scale Z=100%

Adjusting the scale in Z changes the size of the texture along the Z axis.

ROTATION

Using the Rotation control, you can control the angle of the texture on the object's surface. You can create very different texture effects depending on the texture's orientation.



Rotation X=0° Rotation X=45° Rotation X=90°

Since a 3D texture exists in 3D space you can change its orientation in all three axes. Adjusting the rotation in X changes the angle of the texture along the X axis.



Rotation Y=0° Rotation Y=45° Rotation Y=90°

Adjusting the orientation in Y changes the angle of the texture along the Y axis.



Rotation Z=0° Rotation Z=45° Rotation Z=90°

Adjusting the orientation in Z changes the angle of the texture along the Z axis.

You can transform a texture numerically by adjusting the X, Y, and Z coordinates or interactively using the transformation tools.

Position

Using the Offset controls, you can control where the texture appears on the object's surface. When you're using a picture as a component, placement can be vital to the look of the material. For example, if you're placing a decal on an object, use the Position controls to precisely place the image in the center of the object or on the correct face.



Position X=0BU Position X=50BU Position X=100BU

Since a 3D texture exists in 3D space, you can change its position in all three axes. Adjusting the position in X changes the placement of the texture along the X axis.



Position Y=0BU Position Y=50BU Position Y=100BU

Adjusting the position in Y changes the placement of the texture along the Y axis.



Position Z=0BU Position Z=50BU Position Z=100BU

Adjusting the position in Z changes the placement of the texture along the Z axis.

To TRANSFORM A TEXTURE NUMERICALLY:

- 1 In the Texture Component window, click the first button on the left at the top of the window.

The Transformation palette appears.



Use the texture transformation palette to adjust the scale, position, and orientation of the texture component.

- 2 Move your cursor over the control for the transformation you want to apply.
- 3 Drag the cursor over the X, Y, or Z value you want to adjust.
Drag left to increase the value or right to decrease it.
As you adjust the value, the material preview updates to show the results of your changes.
- 4 Click the OK icon to apply your changes.

To TRANSFORM A TEXTURE INTERACTIVELY:

- 1 In the Texture Component window, click the first button on the left at the top of the window.
The Transformation tools appear.
- 2 Move the cursor over the tool you want to use until the mode you want is active.
- 3 As you pass the cursor over the tool, the tool changes to display the different modes available.

- 4 Drag the mouse in the direction you want to move, scale, or rotate the texture.
- 5 Click the OK icon to apply your changes.

EDITING TEXTURES

You can edit the makeup of an existing texture or create a completely new texture using the Deep Texture Editor. This editor uses some rather complex texture-generation concepts to create textures for Bryce. You can either choose to learn all these concepts to create your textures precisely, or use the editor as a type of lab where you combine random settings and see the results.

Refer to “Creating and Editing Textures” on page 169 for more information about learning texture-generation concepts.

COMBINING COMPONENTS

You can combine material components using one of three blending modes:

- Mode A
- Mode AB
- Mode ABC

MODE A

In Mode A, only one component is used to set the value of a channel. The component can be a value, a picture, or a 3D texture.

MODE AB

In Mode AB, two textures are blended together based on altitudes. At the lowest altitudes, the values from texture A are used; at higher altitudes, texture B is used to set the value of the channel.

Altitude is based on the distance between the ground level and the highest object in your scene.

When you use this mode, an object’s surface material is a blend between two texture components. Texture B appears at the bottom of the object and Texture A appears at the top. In

between is a blend between texture B and texture A. Bryce creates the blend by interpolating between the two textures.

For example, if you use ModeAB in the Diffuse Color channel, the color in texture A appears at the bottom of an object’s surface, and the color from texture B appears at the top. A color gradient between color A and color B appears in the middle of the object

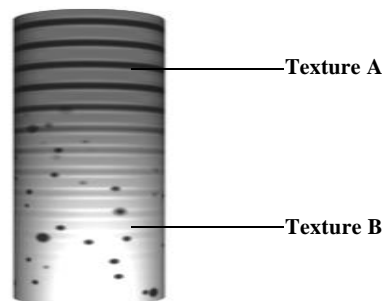

In this example, Mode AB was used to set the Diffuse Color channel. Values from texture A set the Diffuse Color channel at lower altitudes, while values from texture B set the channel at higher altitudes.



Mode AB can be used to create snow covered peaks on terrains or murky depths in infinite water slabs.

TO USE MODE AB TO BLEND TEXTURES:

- In the Materials Lab, Control/Ctrl+click the B column of a channel.
Component indicators appear in both the A and B columns of the channel.

MODE ABC

In Mode ABC, two textures, texture A and texture B, are blended based on the alpha channel of texture C. In this mode, the alpha channel from texture C acts like a map that tells Bryce where to apply the values from texture A and texture B. All the white areas of the alpha channel use values from texture A; black areas in the alpha channel use values from texture B. Gray areas in the alpha channel use a combination of both textures.

Alpha Channel	Texture Used
	Texture A
	Combination of A and B
	Texture B

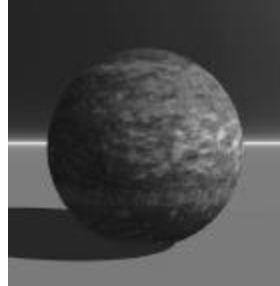

Using a material, you can define whether a surface is shiny, smooth, or opaque.

In the example that follows, three textures were combined using Mode ABC in the Diffuse Color channel.

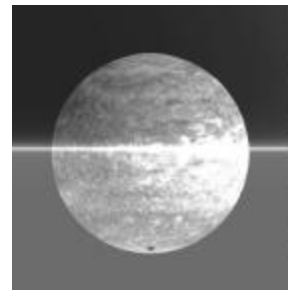
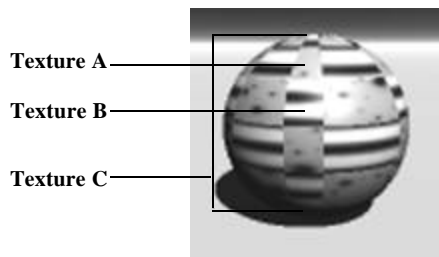

Using a shading mode, you determine how those properties are applied to the object.

When Mode ABC is used to combine the three textures, the spot texture (A) appears in the white areas of the checker texture's alpha channel (C) and the lines texture (B) appears in the black areas of the alpha channel.

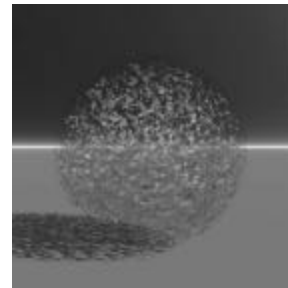

The shading mode can not only determine how the material is applied to the surface of the object, but how it's applied to the object's volume as well.

To use Mode ABC to blend textures:

- 1 In the Materials Lab, Control/Ctrl- click the C column of a channel.
Component indicators appear in the A, B and C columns of the channel.

SHADING MODES

Shading refers to the process of applying material channel values to an object. When an object is shaded, the different values in the material are applied to the object. The shading modes available in Bryce determine how material channels are applied to create different effects.

To choose a shading mode:

- Click the triangle icon next to the material type buttons at the top of the Materials Lab.

SURFACE MATERIAL SHADING MODES

This section explains the surface material shading modes.

NORMAL

Normal mode applies the values of the material without modifying them in any way. Objects are shaded according to the values you set in the material channels. This mode has no special effects; it simulates a real-world appearance using the material channel values.

This is the default mode and is appropriate for most objects.

BLEND TRANSPARENCY

In Blend Transparency mode, visibility is controlled by Transparency. When this mode is active, areas of the object that are 100% transparent are ignored. Transparent areas are not shaded and do not cast shadows. These areas appear as gaps or holes in the object's surface.

This mode lets you create punch-outs when using a texture.

Using Normal Shading

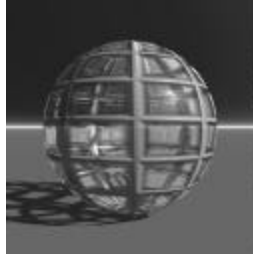

Using Blend Transparency Shading

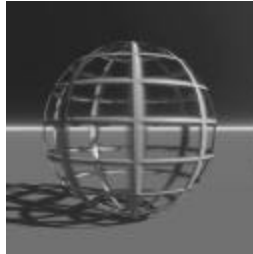

This cage was created by using blend transparency to "punch-out" areas of the object's surface.

Anything less than 100% Transparency results in normal transparent areas.

Fuzzy

Fuzzy mode changes the effective transparency based on the thickness of the object. As a result, objects appear fuzzy on the edges and solid at the center.

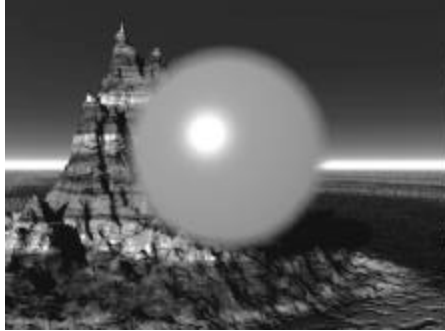

When you apply a material using Fuzzy shading mode, the edges of the object appear blurred, while the center remains solid.

Since Bryce uses depth information to synthesize this blurry effect, it is not available for 2D objects such as Squares or Disks.

Use the Transparency setting to adjust the degree of fuzziness.

LIGHT

Light is a very specialized shading mode best used to create visible lighting effects. Objects shaded with this mode appear transparent and self-illuminating.

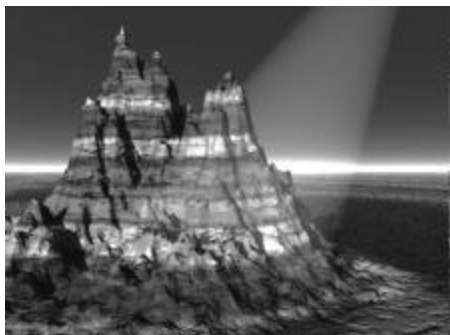

The Light shading mode is designed to create simple light effects. If you apply it to a cone object, it looks like a cone of light.

Only the Diffuse, Ambient, and Transparent Color channels are used to determine the color of the light. All other channels are ignored.

This mode is useful for creating point lights without the rendering overhead that comes with true volume light objects (that is, light-sensitive volume materials).

VOLUME MATERIAL SHADING MODES

This sections explains the volume material shading modes.

FLAT SHADING

Flat shading mode is designed for clouds, gases and other self-luminous gaseous materials. Flat shading mode does not shade an object, meaning that light sources have no effect on the color or brightness of the object.

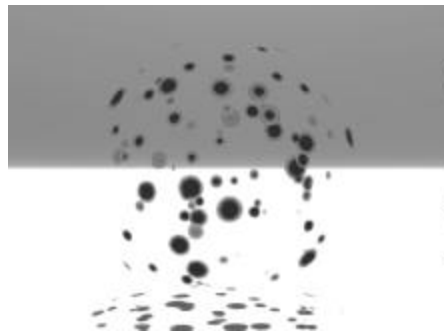

The Flat shading mode applies your material as a volume material, but does not apply any shading.

When this mode is active, Diffusion, Ambience, Specularity, Ambient Color, Specular Color and Transparency Color have no effect.

The color of the material is determined entirely by the Diffuse Color channel.

BASIC SHADING

Basic shading mode is designed to apply shading and light effects to the exterior surface of a volumetric object without affecting the interior. When this mode is active, volumetric objects are shaded as if they have a surface material applied to them rather than the actual volume material.

In this mode, light sources have a limited effect on the color and brightness of an object. Only the exterior surface of the object will be affected by light sources; light and shadows will not be generated within the object.

Full SHADING

Full shading mode is designed for hard edged, sharp objects like rocks. When Full shading mode is active, the visible portions of the material are shaded and can be affected by light sources.

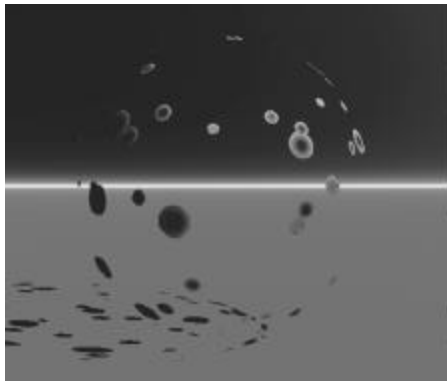

The Full shading mode applies your material as a volumetric material, and applies shading to the visible portions of the material.

Since light sources can affect portions of your material, shadows will appear within the object. This can greatly increase rendering time. If you don't need to see shadows in the object, make sure the Receive Shadows filter is disabled. Usually you should disable this filter unless you're creating very specialized effects.

Light SENSITIVE

Light Sensitive mode is designed for creating visible light effects such as light beams. Light Sensitive mode does not shade objects, but the particles in your material are sensitive to light.

In this mode, Density doesn't control density as much as it sets the light sensitivity of material particles. Higher values create brighter particles and lower values create darker particles.

To get the best results for light objects, use the Additive blend mode.

The color of the particles is determined entirely by the Diffuse Color channel.

The result is like shining a light through a volume. If you were shining a light through a cloud material, you would be able to see the clouds within the light cone.

When this mode is active, Diffusion, Ambience, Specularity, Ambient Color, Specular Color and Transparency Color have no effect.



The Light Sensitive mode was used to apply material inside the bottle on the left. When the bottle is lit by a light source, the particles of the material become visible creating the effect of a light beam passing through the bottle.

Uniform DENSITY

Objects can have varying densities. By default, objects have a density that varies from center to surface. The object is most dense at the center and becomes less dense as you approach the surface. You can control the starting point of this variation in density by using the Edge Softness control.

However, you may want to create objects that do not vary in density. Uniform Density mode sets the object to have a consistent density throughout the

object. The density at the starting point is used throughout the object. This results in harder-looking objects and faster rendering times.

SKY INTEGRATION

Sky Integration mode is designed to increase the realism of volume objects in scenes that have hazy or foggy atmospheres. When Sky Integration mode is active, the sky effects such as haze and fog are taken into account when the volume object is rendered. This helps blend objects realistically into the atmosphere.

This mode is very useful for creating realistic cloud objects or fog objects.

SHADING MODE MODIFIERS

Shading mode modifiers are not shading modes, but they modify an existing shading mode. When you select a modifier it remains enabled until you disable it. You can also apply more than one modifier at the same time.

ADDITIVE

When this modifier is active, material channels are applied to the environment behind the object instead of to the object's surface.

If you put an object on a bright background, it appears almost white. For best results, set your Ambient Color control to zero and render against a dark, plain background. Objects with this shading mode modifier selected will not cast shadows.

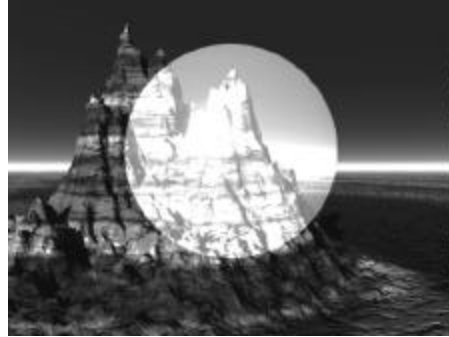

When you modify a shading mode using Additive, objects appear as ghost images.

This mode is very useful for creating planets and quarter moons, light beams, and ghost images.

DISTANCE BLUR

This modifier is designed to minimize the problem created by highly bumpy textures fading into infinity (i.e., the horizon). Often, moiré-like patterns appear in these cases as the pixels try to resolve the infinitely receding high frequencies of bumpy water or grooved sand, and so on. The Distance Blur modifier fades the bumpiness well before it hits the horizon.

RECEIVE SHADOWS

This modifier prevents an object's surface from accepting shadows cast by objects around it. The object itself will cast a shadow, but it won't accept shadows from other objects.

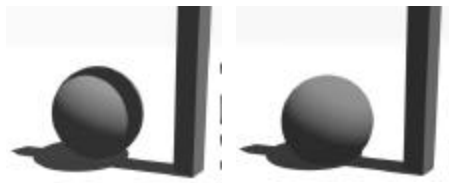

When the Receive Shadow filter is disabled, no shadows will appear on the object's surface.

CAST SHADOWS

This modifier prevents an object from casting shadows. The object's surface still reacts normally with light but it does not cast any shadows.

SELF SHADOWS

This modifier prevents an object from casting a shadow onto itself, yet still shadow all the other elements of the scene.

VOLUME BLEND-ALTITUDE

This modifier gradually blends in the Volume color based on altitude. Areas at lower altitudes are tinted with the 100% Volume Color; as you move higher up, less of the Volume Color is added.

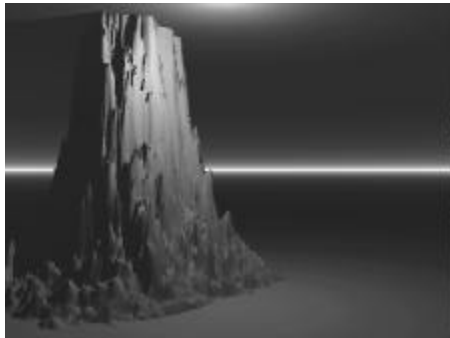

Using the Volume Blend-Altitude, you can simulate the effects of sinking deeper into a volume of water. The lower you sink, the darker it becomes.

This modifier can be used to create a sense of depth in an infinite water slab. If you blend between a light Diffuse Color and a darker Volume Color, you can create the illusion of depth as you sink deeper into the water.

VOLUME BLEND-DISTANCE

This modifier blends the Diffuse and Volume Colors of your material based on the distance from the camera. Areas that are closer to the camera will be tinted less with the Volume Color. As you move further away, more of the Volume Color is visible.

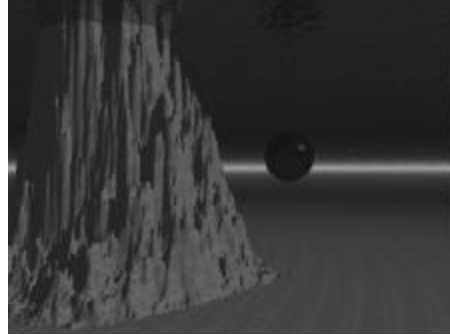

Using the Volume Blend-Distance, you can simulate the effects of looking through murky water. Distant objects appear darker than closer ones.

This modifier is excellent for creating underwater depth effects. If you blend a darker Diffuse Color with a lighter Volume Color in an infinite slab, you can simulate the effects of murky water on distant objects.

THE MATERIALS LAB

The Materials Lab is where you create and edit your materials in Bryce. This unique editor lets you combine a wide variety of components and channels to create an infinite number of different surfaces and volumes.

To display the MATERIALS LAB:

- 1 Create an object.
- 2 Select the object in the Working window. A number of object attribute icons appear to the right of the object.

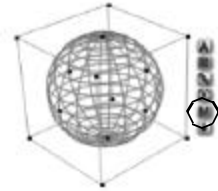

Use the quick access buttons next to a selected object to access editors and get information about the object.

- 3 Click the M icon. Alternatively, you can choose Objects menu > Edit Material or display the Edit palette and click the Edit Material tool.

The contents of the composer depend on the material currently applied to the object. If there is no material, the default material's settings appear.

A QUICK TOUR OF THE MATERIALS LAB

The Materials Lab is set up like a visual chart that lets you see all the different channels that make up your material. At a glance, you can see all the settings for each material channel and the texture components used to drive channel values.

In the top left corner is the mode toggle button. This button lets you switch between surface material and volume material. The buttons also indicate what type of material you're creating. Surface is enabled by default. When you toggle to Volume, the channels in the lab change to display the volume channels.

MATERIAL PREVIEW WINDOW

On the left side of the Materials Lab is the Material Preview. This little window shows you what your material will look like when it is applied to an object. The preview updates as you adjust the channels.

THE MATERIALS GRID

The center of the Materials Lab is called the Materials Grid. This is where you combine values, colors and textures to set channel values. The Materials Grid is divided into three sections each containing logical groups of channels.



The Material Grid gives you a one-glance view of all the channels that make up your material.

The Color channels group contains all the material channels that define the colors that appear on the object surface when it's struck by light.

Each channel in the Color group has a color oval next to its title. This oval lets you quickly set a color for the channel.

The Value group contains all the channels that define how the object's surface or volume reacts to light. In other words, they control whether the object is shiny, metallic, bright or dark.

The Optics group contains all the channels that define any optical effects associated with the object.

When you're creating volume materials, the Optics group is replaced by the Volume group. This group contains all the channels that define the appearance of an object's volume.

All of the channels in these three groups have sliders on the left side of each row. The sliders let you quickly set the value of each channel. Values

can be used in conjunction with textures or on their own. In the case of the Refraction channel, you must use a value.

Each channel is divided into four columns: A, B, C, and D. These columns represent texture components you can use to set the value of the channel. At the top of each column is a Frequency slider. This slider lets you quickly set the frequency of a texture component. Setting the frequency is the same as scaling the texture.

When a texture component indicator appears in a column, it means that a component is being used to drive the value of the channel. The column in which the indicator appears indicates which texture component is being used. For example, if a texture component indicator appears in column A of the Ambience channel, component A is being used to drive the Ambience value.

TEXTURE COMPONENT WINDOWS

Along the right side of the lab are the Texture Component windows. These four windows are labeled A, B, C, and D. When a texture component is active, these windows display a preview of the texture and provide access to texture editing tools.

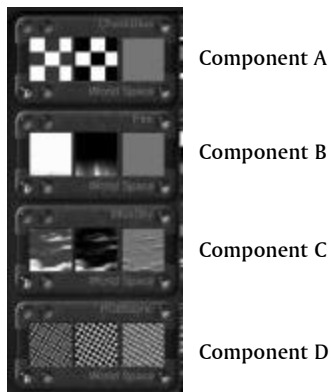

The four Texture Component windows correspond to the four columns in each channel in the Materials Grid

Along the bottom of the Materials Lab are the Animation controls. These controls let you animate between textures or animate the properties of a single texture over time.

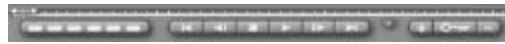

Use the Animation controls to animate a material over time.

WORKING IN THE MATERIALS LAB

This section describes how to use the Materials Lab to create and store materials.

Building MATERIALS

A material is a combination of values, colors and textures applied through fourteen different channels. You build materials by selecting components (colors, values, or textures) and combining them on the Materials Grid.

TO CREATE A NEW SURFACE MATERIAL:

- 1 Select an object.
- 2 Display the Materials Lab.
- 3 Set the material channels to define the properties of your material.

Remember, channels can be set using values, colors or texture components. You may want to experiment with different setting to see the results of your changes.

- 4 If you're using texture components, you can:
 - Edit the scale, position or rotation of the texture using the texture transformation controls.
 - Edit the makeup of the texture using the Deep Texture Editor.
 - Set a mapping mode for the texture.
- 5 Choose a shading mode for the material by clicking the triangle icon at the top of the Materials Lab and choosing a mode from the menu.

- 6 Click the OK icon. The new material is applied to the selected object.

To CREATE A NEW VOLUME MATERIAL:

- 1 Select an object.
- 2 Display the Materials Lab.
- 3 Click the toggle button to switch to Volume.
- 4 Set the material channels to define the properties of your material.

Remember, channel values are applied to the object's volume not its surface, so adjust the material's channels accordingly.

- 5 If you're using texture components, you can:
 - Edit the scale, position or rotation of the texture using the texture transformation controls.
 - Edit the makeup of the texture using the Deep Texture Editor.
 - Set a mapping mode for the texture.

You should always use a texture component in the Base Density channel.

- 6 Choose a shading mode for the material by clicking the triangle icon at the top of the Materials Lab and choosing a mode from the menu.

The shading modes for volume materials are different from those for surface materials.

- 7 Click the OK icon. The new material is applied to the selected object.

To ACTIVATE A COMPONENT IN THE MATERIALS Grid:

- Click an empty channel column. A component window appears.

To USE A COMPONENT IN A CHANNEL:

- In a material channel, click the column that corresponds to the component you want to use.

To SWITCH BETWEEN COMPONENTS:

- Click in a new column.

To COMBINE A COMPONENT WITH A VALUE:

- 1 In a material channel, click an empty column.
- 2 Drag over the value control for the channel.

COPYING AND PASTING MATERIALS

The Materials Lab has its own dedicated clipboard that lets you store materials. You can have an object in your clipboard, then enter the Materials Lab and copy a material without disturbing the contents of your clipboard.

To COPY A MATERIAL TO THE MATERIALS clipboard:

- Click the Copy button below the Material Preview window.

To PASTE A MATERIAL TO THE MATERIALS clipboard:

- Click the Paste button below the Material Preview window.

USING THE MATERIAL PREVIEW AREA

There are several different ways you can see the effects of your material on an object.

To SWITCH PREVIEW MODES:

- Click the triangle at the bottom of the material preview and choose an option from the menu:
 - Normal displays your object as it looks in your scene. This is the default view of your selected object.
 - Up Close displays a zoomed-in view of your object.

Render With Neutral Sky displays your object against a plain sky. When this option is disabled, your preview contains the current sky settings. This option makes it easier to see the material without being distracted by patterns in the sky.

Render With Neutral Ground displays your object with a plain ground. When disabled, the ground in your preview has the same texture as the object.

Current Selection displays the selected object exactly as it appears in the your scene.

Box displays the material applied to a cube.

Sphere displays the material applied to a sphere.

Cone displays the material applied to a cone.

Cylinder displays the material applied to a cylinder.

Terrain displays the material applied to a randomly generated terrain object.

Ground displays the material applied to an infinite plane.

Torus displays the material applied to a torus object. Torus objects are good for displaying material properties like altitude changes, slope and height changes, and metallicity.

To change the view angle of the preview area:

- Drag the Preview area in the direction you want to view it from.

The preview switches to wireframe as you move it. The angle of the preview does not affect the angle of the object in your scene.

MATERIAL PRESETS

Material presets are predefined materials. Presets contain channels values that simulate a wide variety of commonly used surfaces. Presets are stored in the Material Presets Library.

Presets are a great way of understanding how materials are made. You can open one of the presets and see what channel and components were used to create the final material.

The Material Presets Library can also be used as a cookbook. Some of the shaders are organized as lessons that can lead you through the process of creating interesting effects. For example, try opening the Specularity lessons in the Simple & Fast category.

Using the MATERIALS PRESETS LIBRARY

The Materials Presets Library contains all the material presets available in Bryce. You can place them on your objects directly and edit them just as you would any other material.

To add a material from the MATERIALS PRESETS LIBRARY to an object:

- 1 Select an object.
- 2 In the Working window, click the triangle icon next to the Edit text button at the top of the Bryce environment. The Materials Presets Library appears.
or
In the Materials Lab, click the triangle icon at the top-right of the Material Preview window.
- 3 Click one of the Category names along the left side of the dialog.
- 4 Click the thumbnail of the preset you want to add.
- 5 Click the OK icon to add the selected material to your object.

You can also select presets in one motion by clicking the Materials Presets icon then dragging directly to the desired material preset and releasing the mouse button. You can also drag over the category names to change categories into the category's presets, and then release mouse button.

Adding and Deleting Preset Materials

You can add the material from any object to the Preset Materials Library. This is a good way of saving your favorite materials.

To add a material to the library:

- 1 Select the object whose material you want to add to the library.
- 2 Click the triangle icon next to the Edit text button at the top of the Bryce environment. Your selected object will appear in the preview area of the Preset Material Library dialog.



The preview area displays the object you selected.

- 3 Click a category name. The library switches to the category you selected.

The new preset will be added to the category you select.

- 4 Click the triangle icon at the bottom right corner of the preview and choose a view option from the menu.

Normal is the default view of your selected object.

Up Close displays a close-up of your object.

Render With Neutral Sky displays your object with a flat sky instead of the sky applied to your scene.

Render With Neutral Ground displays your object on a flat ground plane instead of the ground used in your scene.

Current Selection displays your object exactly as it appears in your scene.

Box displays your material applied to a cube.

Sphere displays your material applied to a sphere.

Cone displays your material applied to a cone.

Cylinder displays your material applied to a cylinder.

Terrain displays your material applied to a terrain. You might want to disable Render With Neutral Ground as terrain materials look better when placed on a ground plane with the same material.

Ground displays your material applied to an infinite plane.

Torus displays your material applied to a torus object.

- 5 Drag the preview area to rotate the view of your object.
- 6 Hold down the Spacebar and drag up, down, right, or left to pan the object preview.
- 7 Hold down Command/Ctrl and drag in the preview area to zoom in and out of the preview.
- 8 Click the Add button at the bottom of the dialog. The Add Material dialog appears.
- 9 Enter a name for the new preset in the Preset Name field.
- 10 Enter a description of the preset in the Description field and click the OK icon.
The name and description will appear next to the material preview whenever the preset is accessed.
- 11 Click the OK icon. Your preset will be added to the first available space within the current category.

You can edit the name and description of any preset at any time by clicking the name or description.

To delete a material preset:

- 1 Click the triangle icon next to the Edit text button at the top of the Bryce environment. The Preset Materials Library appears.
- 2 Click the preset you want to delete.
or
Hold down Shift and select a continuous series of presets.
or
Hold down Command/Ctrl and select a discontinuous set of presets.
- 3 Click the Delete button at the bottom of the Preset Materials Library dialog.

IMPORTING AND EXPORTING PRESET MATERIALS

Importing and exporting presets is a handy way to exchange custom presets with other users.

To import a preset material file:

- 1 Click the triangle icon next to the Edit text button at the top of the Bryce environment. The Preset Materials Library appears.
or
In the Materials Lab, click the triangle icon next to the Material Preview window.
- 2 Click the Import button at the bottom of the Preset Materials Library dialog. The Open dialog appears.
- 3 Locate the file you want to import and click Import.
The contents of the file are placed into the first available space in the current category.

To export a preset material file:

- 1 Click the triangle icon next to the Edit text button at the top of the Bryce environment. The Preset Materials Library appears.

- 2 Select the preset or presets you want to export.
- 3 Click the Export button at the bottom of the Preset Materials Library dialog. The Save File dialog appears.
- 4 Enter a name and location for the file and click Save.

You can create your own folders for presets, letting you organize presets into your own categories. Refer to “Adding and Deleting Preset Folders and Categories” on page 76 for more information on creating your own preset folders and categories.

ANIMATING MATERIALS

Animating materials can add an exciting new dimension to your materials—time. Using the Animation controls, you can interpolate between textures over time or change the properties of a single texture over the course of an animation.

The animation tools are a great way of adding life to your scene. Instead of creating an animation with simple motion, you can create subtle effects like changing a cube from water to ice or changing the seasons on a mountain.

Refer to “Animating Materials” on page 350 for complete instructions on animating materials.

SPEEDING UP MATERIALS

While there is almost an infinite number of materials with the added complexity of creating materials using multiple components and adding volumes, you need not use all the features of the lab all at once.

The more complex your material, the longer it takes to render so you should use complexity only where it’s necessary.

Rendering Transparency, Reflection, and Refraction always requires longer rendering time, but when you add the complexity of creating transparent, reflective, or refractive volumes, your rendering time can increase exponentially. If you find that

your scene is taking too long to render, you may want to try setting the Transparency, Reflection and Refraction values to zero.

Additionally, use Full Shading Volume textures sparingly. This type of material creates specific types of effects, so you should limit these materials to specific areas of your scene. If you spread Full Shading Volume textures everywhere throughout your scene, be prepared for a long wait while the scene renders.



8

CREATING AND EDITING TEXTURES

One of the things that makes Bryce so unique is its materials. A material can bring any object to life, and textures are the power behind the material. A material can make your object shiny, dull, or transparent, but the textures within that material are what make it look like wood, rock, water, or clouds.

Textures define the color, pattern or bumps within a material. A material can contain up to four textures. By altering the make-up or pattern of a texture you can dramatically alter the appearance of a material.

TEXTURE STRUCTURE

A Bryce texture can be made up of three components. These components contribute the raw patterns or textures within a texture. Each component can then contribute one of three types of output to the final texture. These outputs are then combined to create the final texture.

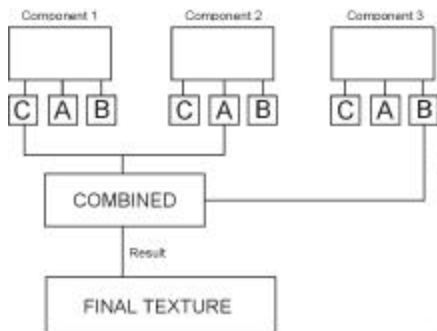

This diagram shows the structure of a texture.

Within each component is a combination of colors and noise that create a pattern. The shape of the noise inside a component is determined by the phase of the noise and the filter applied to it. The filter can create coherent patterns, random spots or anything in between. Refer to “Noise” on page 177, “Phase” on page 183 and “Filtering” on page 186 for more on noise, phase and filtering.

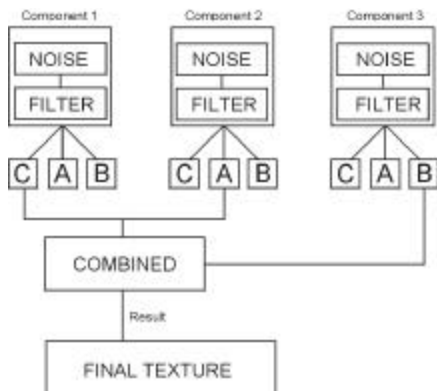

This diagram shows the structure of a texture including the structure of a component.

A component can contribute one of three types of output to the final texture: Color output, which determine the colors in a texture, Alpha output, which determines the bright and dark areas in a texture, and Bump output, which determines the size and pattern of bumps in the texture.

The component can contribute any combination of outputs. So you can have a final texture that contains Color output, Alpha output, and Bump output, or it can have all Color output or all Bump, or any combination of the three.

The outputs in a texture are used by the material, so the type of output you have in a texture depends entirely on how you want to use the texture in the material. For example, if you’re using the texture as a bump map for the Bump Height channel in a material, you’d probably want all the components to contribute only Bump output.

A texture can contain up to three components. It can be made up of all three components or just one, depending on the type of texture you want to create. The more components you use, the more complex your texture.

Components are combined using Blend Modes. These modes can create a wide range of effects.

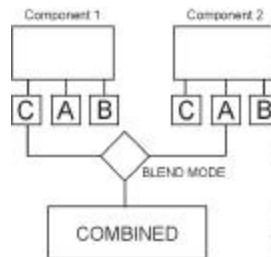

The way components are combined to create the final texture is determined by the Blend Mode you select.

Components are combined differently depending on how many you use. If you use one or two they are combined according to the blend method you select. If you use three, the first two components are combined, and the resulting texture is then combined with the third component to create the final texture.

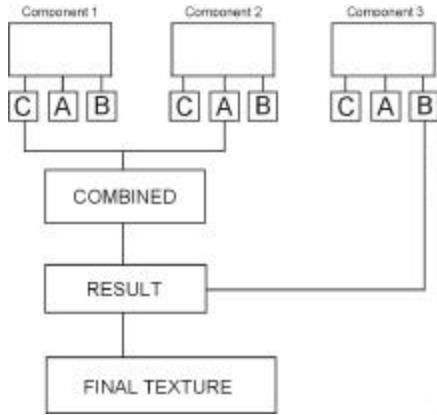

When you use three components, the first two components (C1 and C2) combine to create a hybrid texture which is then combined with the third component (C3) to create the final texture. So they're combined using the formula $(C1 + C2) + C3 = FINAL$.

The texture components are combined together to form the final Combination texture. The final texture can have its own color scheme, noise, phase or filter. Any changes you make to the combination texture changes the final texture. These types of operations are called Global changes. Refer to "Global Changes" on page 194 for more on global changes.

The end result of the Global changes is the final texture which can then be used in the Materials lab to create a material.

COMPONENTS VS. TEXTURE COMPONENTS

Before you get any deeper into the discussion of texture structure you should understand a little terminology.

A texture is a part of a material. It can be used to drive any of the material's channels. When you use a texture in a material, it's called a *material component*.

The texture itself also has components. It can be made up of up to three components that determine the look and color of the texture. The components that make up a texture are called *components*.

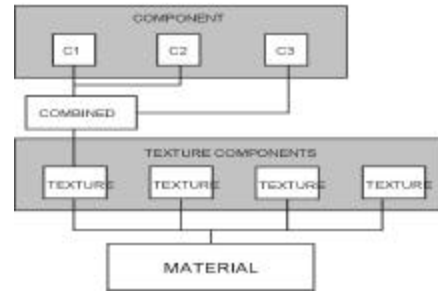

The difference between components and texture components may be a bit confusing. Just remember that when you're talking about a texture, you're dealing with components. When you're working with materials, you're using texture components.

UNDERSTANDING COMPONENT STRUCTURE

A texture can have up to three components. When combined, the components create the final texture. A component consists of noise and color.

A component can have up to three colors. The combined texture can also have a different set of three colors which is added to the colors from the components. In total your texture can contain up to twelve colors.

The noise in a component is made of base Noise which is modified by the Phase, which controls the complexity of the noise, and the Filter, which determines the shape or pattern of the noise.

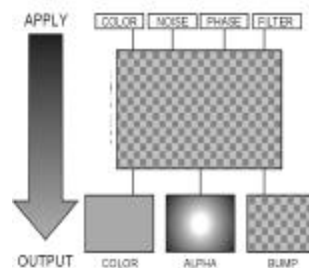

A component consists of noise and color. The Noise is modified by the Phase and the Filter. Each component can then produce Color, Alpha or Bump output.

COMPONENTS AND OUTPUT

A component's output type determines what type of information it's going to contribute to the final texture. The Output type also determines the component's structure. A component that does not have a Color output won't contain any color information. The same is true for the two other types of output. If there's no Alpha or Bump output there's no Alpha or Bump information in the component.

COMPONENT OUTPUT

The main purpose of creating a component is to use it as part of a material which will then be applied to an object. How and what a texture contributes to a material is determined by the type of output it produces.

A texture can produce three different types of output: Color, Alpha and Bump.

When you apply a texture to a material, you can see the output types in the Texture Component Window in the Materials Lab.

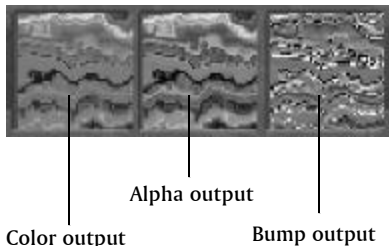

The three boxes in the Texture Component Window in the Materials Lab represent the three output types available for a texture.

If a texture does not produce a particular output the box appears gray.

Refer to "Texture Components" on page 145 for more on using textures in materials.

In the Deep Texture Editor, the output type for a component is indicated by the three output buttons along the right side of the Component Window.

ASSIGNING OUTPUT TYPES

A texture can produce all three output types or only one. The number of output types for the final texture depends on the output you assign to the components. A component can produce one or all three types of outputs.

You can assign more than one component to the same output type. If you do have more than one component with the same output type, the output information will be blended to produce a final output.

For example, if you have two components that produce Color output, when you combine them the colors from both components are blended together and the result is applied to the final texture.

In order to produce an output type, a final texture must contain at least one component that produces the type of output you want. For example, if you want your final texture to contain color output, at least one of its components must produce color output.

Each output type contributes something different to the final material.

COLOR OUTPUT

Color output is used by the color channels of a material. The color values you assign to a texture's components are combined to form a final texture. The combined values are then used to drive the Diffuse, Ambient, Specularity, Specular Halo, or Transparency color channels. Refer to "Understanding Surface Material Channels" on page 128 for more on these channels.

The colors in a texture usually appear in the form of a pattern or grain. When you assign the texture to a material, this pattern appears in the final material.

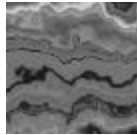

Original Texture



Material containing texture

The texture in this example was applied to the Diffuse color and Ambient Color channels of the object's material. You can see how the color pattern in the texture appears in the material.

To assign Color output to a texture:

- 1 Display the Deep Texture Editor.
- 2 In the desired component window, click the C button on the right side of the component window.

Alpha Output

Alpha output is used by the various Intensity and Optic channels of the material. When a texture's Alpha output is assigned to a material, it's used either to determine an effect's intensity or as a guide map for combining multiple textures.

When there is only one texture component in a material channel, the texture's Alpha output is usually used to determine the intensity of a channel effect. For example, if you assign a texture to the Diffuse channel, the texture's Alpha output is used to determine which areas are the most diffuse and which are the least diffuse.

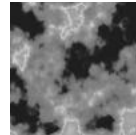

Original Texture



Material containing texture

The texture in this example was applied to the Diffuse channel of the object's material. You can see how the alpha pattern in the texture controls the diffuse intensity on the object's surface.

To assign Alpha output to a texture:

- 1 Display the Deep Texture Editor.
- 2 In the desired component window, click the A button on the right side of the component window.

Bump Output

The Bump output is used only by the Bump Height material channel to determine the pattern and height of the bumps in a material.

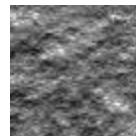

Original Texture



Material containing texture

The texture in this example was applied to the Bump Height channel of the object's material. You can see how the bump output in the texture controls the pattern of bumps on the object's surface.

To assign Bump output to a texture:

- 1 Display the Deep Texture Editor.
- 2 In the desired component window, click the B button on the right side of the component window.

COMPONENT ELEMENTS

A texture is made up of components. Each of those components can contain several elements that determine the color, pattern, grain or bumps in the component.

THE COMPONENT WINDOW

You can have up to three components in your texture. As you activate components, a component window becomes active. Each window displays a preview of the component elements.

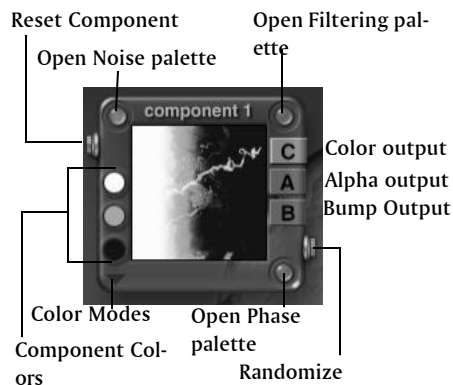

The Component window displays the selected component and its current attributes.

The three buttons on the Component window let you access the Noise palette, the Filtering palette and the Phase palette. The buttons along the right side of the window indicate the type of output produced by the component.

TO ACTIVATE A COMPONENT:

- 1 Display the Deep Texture Editor.
- 2 Click the component selector in the top-left corner of the editor.

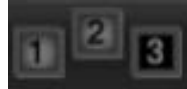

The component selector lets you pick how many components you want to use to build your texture.

The selector lets you choose from 1, 2, or 3 components.

Color

The colors in a component determine its color scheme. Each component can have up to three colors. Colors can be chosen using the color picker or the Color dialog.

The color in a component is affected by the noise, filter and phase. You can create some very interesting patterns of color by modifying the noise. The color pattern created by the changes in the noise is applied directly to the final texture. So even if Color is the only output type for the component you'll still see a pattern in your final texture.

When the Color Output is selected for a component, only the color information is combined with the other components. Also, when you apply the texture to a material, the colors in the component contribute to the colors used in the Color channels of the material.

There are two color models you can use to create colors in the components: RGB and HLS. RGB combines red, green and blue to create color. HLS combines Hue, Lightness and Saturation values to create color. The method you choose depends on the final output of your Bryce scene. RGB works best for most types of output.

If the Color output is not active for a component, changing the colors or Color Blending Modes has no effect.

TO ACTIVATE COLOR OUTPUT FOR A COMPONENT:

- 1 Display the Deep Texture Editor.

- 2 In the desired component window, click the C button.

An output type is active when the button appears light gray.

To choose colors for a component:

- 1 Display the Deep Texture Editor.
- 2 In the desired component window, make sure the C button is active.
- 3 Click one of the color indicators along the left side of the component window and choose a color from the palette.



The three color indicators along the left side of the window display the colors used in the component.

To mix colors for a component:

- 1 Display the Deep Texture Editor.
- 2 In the desired component window, make sure the C button is selected.
- 3 Option/Alt-click the one of the color indicators along the left side of the component window. The Color dialog appears.
- 4 Choose a color model by clicking one of the buttons along the bottom of the dialog.
- 5 Enter color values or adjust the sliders to mix a new color.
- 6 Click the OK icon.

Color Blending Modes

There are several blending modes you can use to create a color scheme.

To choose a Color Blending mode:

- 1 Display the Deep Texture Editor.
- 2 In the desired component window, make sure the C button is active.
- 3 Click the triangle icon in the lower left corner of the window and choose a mode from the menu.

NONE

No blending is applied.

RED OR HUE

When the RGB model is used, this mode outputs only red color values. When the HLS model is used, only Hue values are output.

This mode and the Green or Light, and Blue or Saturation mode are available so that you can separate color values among the components. For example, you could set each component to output one of the different color values.

GREEN OR LIGHT

When the RGB model is used, this mode outputs only green color values. When the HLS model is used, only Lightness values are output.

BLUE OR SATURATION

When the RGB model is used, this mode outputs only blue color values. When the HLS model is used, only Saturation values are output.

Spline Interpol

This mode creates a blend between all the colors in the component.



This is what a color blend looks like using Spline Interpol.

LINEAR INTERPOL 2

This mode creates a linear blend between the first two colors selected for the component.



This is what a color blend looks like using Linear Interpol 2.

LINEAR INTERPOL 3

This mode creates a linear blend between all the colors in the component.



This is what a color blend looks like using Linear Interpol 3.

RANDOMIZED

In this mode the three colors are blended and then applied randomly throughout the component.



This is what a color blend looks like using Randomized.

EARTH MAP

In this mode extra colors are generated according to the contours of the component's bump map. The three colors you selected for the component are applied to the middle range of the bump map. Blue

is applied to the lowest bump values and white is applied to the highest values to simulate polar caps. Earth Map is excellent for creating planets.

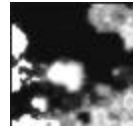

This is what a color blend looks like using Earth Map.

BANDED

In this mode colors are applied in bands. The bands are determined by color values. Colors with the lowest value (i.e. dark colors) are applied to the bands furthest from the center, colors with middle range values are applied next and colors with the highest values (i.e. bright colors) are applied closest to the center.



This is what a color blend looks like using Banded.

PERTURBED

In this mode colors are applied in irregular patterns.

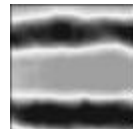

This is what a color blend looks like using Perturbed.

INTERFERENCES

In this mode the red, green and blue values of the first color in the component are used to create a repeating pattern around the contours of the component's noise.



This is what a color blend looks like using Interferences.

INTERPOL + INTERFERENCES

This mode is a combination of Linear Interpolation and Interferences.



This is what a color blend looks like using Interpol + Interferences.

ALTITUDE

In this mode a white layer is added above the colors at high altitudes. Any portion of the object below ground is automatically colored blue. Altitudes are based on the object's height.



This is what a color blend looks like using Altitude.

SPLINE WITH SNOW

This mode performs a spline interpolation of the colors in the component, but adds a white layer above the colors at high altitudes. Altitudes are based on the object's height.



This is what a color blend looks like using Spline with Snow.

SLOPE

In this mode the three colors are applied to the object depending on its slope.

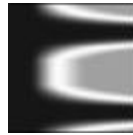

This is what a color blend looks like using Slope.

ORIENT

In this mode the three colors are applied to the object according to its east-west orientation.

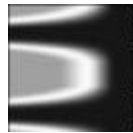

This is what a color blend looks like using Orient.

NOISE

Noise is the background turbulence that creates the basis for texture patterns.

In audio terms you can think of noise as the background static that you hear on old recordings. Sound is layered on top of this noise to create music. Like in audio, you layer other functions on top of the noise in your texture to create the final pattern or look of your texture.

There are two ways of creating noise: the Noise palette or the Noise Editor.

The Noise palette can increase or decrease the amount of noise in any of the texture components. However, using the palette, you can only edit the existing noise.

To display the Noise palette:

- 1 Display the Deep Texture Editor.
- 2 Click the Noise button at the bottom of the editor. The Noise palette appears.

or

Click the Noise button in the top-left corner of any of the component windows.

The Noise Editor is much more powerful than the Noise palette. It contains controls for creating noise from scratch.

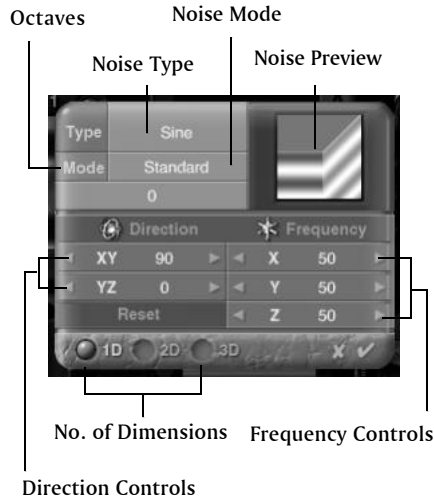

The Noise Editor lets you create noise and adjust its properties.

To display the Noise Editor:

- 1 Display the Deep Texture Editor.
- 2 Click the Noise button at the bottom of the editor. The Noise palette appears.
- 3 Click the top-left corner of the palette. The corner turns green as you pass your cursor over it.

CREATING NOISE

The Noise Editor is the tool you'll use to create noise with a component or combined texture. The noise creation process involves several steps:

- Choose the number of dimensions in the noise.
- Choose a Noise Type. This will give the basis for creating a noise pattern or grain.
- Adjust the frequency of the noise.

- Adjust the direction of the noise.
- Apply a modifier to your noise, by choosing a Noise Mode.

The following sections describe the various parts of the editor and how to use them in the noise creation process.

NOISE DIMENSIONS

Texture in Bryce can exist in 3D so your noise can have up to three dimensions. Noise dimensions determine which axes you can use to adjust the orientation and frequency of the noise.

It's easier to see the number of dimensions for your noise if you use a cube in the Noise Preview.

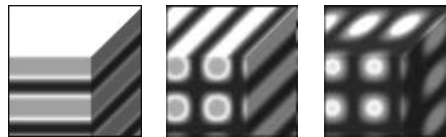

1D Noise 2D Noise 3D Noise

These three examples show the difference between 1D, 2D and 3D noise.

To choose the number of dimensions for your noise:

- 1 Display the Deep Texture Editor.
- 2 Display the Noise Editor.
- 3 Click one of the dimension buttons at the bottom of the editor.

Noise Type

There are 27 different types of noise available in the Noise Editor. Random noise is the default (RND).

Each noise type provides you with a different basic pattern to start your texture. Some are more linear or geometric while others are more random.

More complex noise types require more rendering time. The time it takes to render the preview is a good indication of how long the final texture will take to render.

You should use the more complex noise types cautiously.

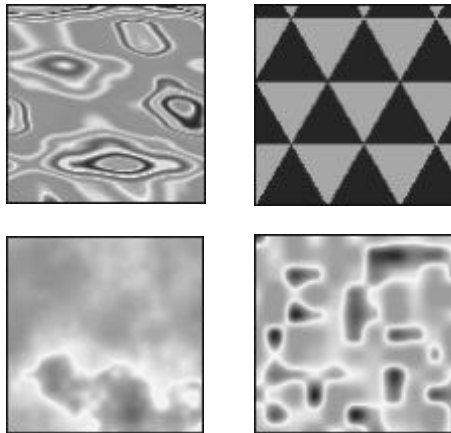

These are examples of the some of the types of noise available.

The best way of choosing a noise type is to apply a few to your component and see how they look. Remember that this noise is only the basis of the texture. You can still edit this noise using the other controls in the editor, so don't discard a noise type because it's not perfect. The other controls can help you fine-tune the noise.

To choose a noise type:

- 1 Display the Deep Texture Editor.
- 2 Display the Noise Editor.
- 3 Click the Type field at the top of the editor and choose a noise type from the menu.

Noise Frequency

Noise Frequency determines how often the pattern within a texture repeats. Frequency is like scaling the noise. Higher frequencies decrease the scale of the noise so you can see the pattern more often. Lower frequencies increase the scale of the noise so the pattern repeats less often.

You can change noise frequency using the Frequency fields. The fields let you enter numerical values to adjust the noise frequency along the X, Y or Z axis. You can also adjust the values using the scroll arrows.

The number of dimensions in the noise determines how many axes you can use to adjust the frequency. For 1D noise you can only use the X axis. With 2D noise you can use both the X and Y axes. For 3D noise you can use all the axes.

If you try to adjust the Z axis frequency for a 2D noise, your changes will have no effect.

Adjusting the frequency can radically change the look of your noise. If you adjust the frequency in separate axes, you can achieve even more interesting effects.

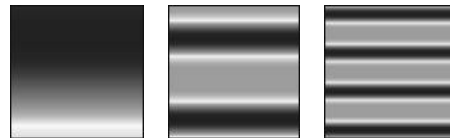

Frequency = 10 Frequency = 50 Frequency = 100

Noise frequency settings control the repetition of patterns in a component.



Frequency X=10 Y=80 Z= 10

In this example, the noise frequency was changed in only the Y axis.

To change the frequency of noise:

- 1 Display the Deep Texture Editor.

- 2 Display the Noise Editor.
- 3 Drag over the X field in the Frequency area to set the noise frequency in the X axis.
Drag left to decrease the value or right to increase it.
- 4 Drag over the Y field in the Frequency area to set the noise frequency in the Y axis.
- 5 Drag over the Z field in the Frequency area to set the noise frequency in the Z axis.

You can also drag over the scroll arrows to speed up the increments.

NOISE ORIENTATION

Noise Orientation controls the direction of the noise. When you adjust the noise orientation, you change how the noise is laid out within the texture.

When you apply a texture, the direction of the noise within the texture remains constant regardless of the orientation of the object.

Since noise can exist in three dimensions, you adjust the direction of the noise in the X, Y, or Z axis.

The number of dimensions in the noise determines how many axes you can use to adjust the orientation. For 1D noise you can only use the X axis. With 2D noise you can use both the X and Y axes. For 3D noise you can use all the axes.

You can edit the noise orientation using the Direction numerical fields. The fields let you enter precise angles for noise orientation. You can also use the scroll arrows to set the angle in increments.

Changing noise orientation can dramatically change the look of your noise. You'll see just how different your noise can look when you rotate it along a single axis.

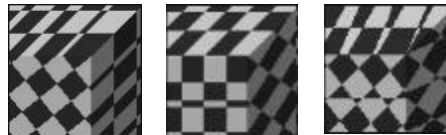

Rotation in X Rotation in XY Rotation in XYZ

Noise orientation controls the direction of the noise.

TO CHANGE THE ORIENTATION OF NOISE:

- 1 Display the Deep Texture Editor.
- 2 Display the Noise Editor.
- 3 Drag over the XY field in the Direction area to set the noise angle in the X and Y axes.
Drag left to decrease the value or right to increase it.
- 4 Drag over the YZ field in the Direction area to set the noise angle in the Y and Z axes.

You can also drag over the scroll arrows to speed up the increments.

NOISE OCTAVES

Noise octaves are like musical octaves. In a musical scale, if you play F and then F an octave down, you're playing the same note, only it sounds lower. If you play both notes at the same time, the sound is more complex than if you played only one note. The same is true of noise. When you add an octave to noise it becomes more complex but the type of noise remains the same.

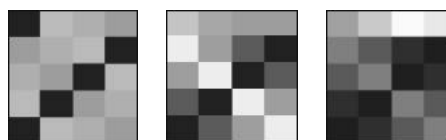

1 Octave 2 Octaves 3 Octaves

These examples use RND Continuous noise and RND Linear noise to show the effects of increasing octaves.

Increasing the octaves adds processing time to the component.

To change the number of octaves:

- 1 Display the Deep Texture Editor.
- 2 Display the Noise Editor.
- 3 Drag over the octaves field at the top of the editor.

Noise Modes

Noise modes modify the octaves of a noise. As you add complexity by increasing the octaves, the Noise Modes let you modify the additional noise so that it produces different effects.

Many of the Noise modes use dark and light values to modify the existing noise. Also, you may not see the effects of the modes if the Octave is set to 0.

To choose a Noise Mode:

- 1 Display the Deep Texture Editor.
- 2 Display the Noise Editor.
- 3 Click the Mode field at the top of the editor and choose a mode from the menu.

There are thirteen noise modes available:

STANDARD

This mode adds a new octave to the noise at half the frequency and twice the amplitude. This is the default mode.

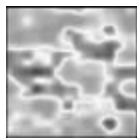

In this example, Standard mode was applied to RND Continuous noise.

IRREGULAR

This mode adds a new octave to the noise at half the frequency and twice the amplitude. However, in this mode higher frequency noise is modified more than the rest. The end result is that more detail is added to the noise.

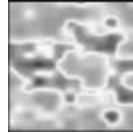

In this example, Irregular mode was applied to RND Continuous noise.

MORE IRREGULAR

This mode works exactly like Irregular except that this mode is more intense.

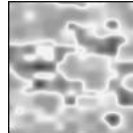

In this example, More Irregular mode was applied to RND Continuous noise.

MAXIMUM

This mode uses the only the highest values, or lightest areas, to produce the modified noise.

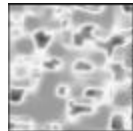

In this example, Maximum mode was applied to RND Continuous noise.

MULTIFRACTAL

In this mode lighter areas create higher contrast noise.

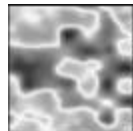

In this example, Multifractal mode was applied to RND Continuous noise.

With ROTATION

In this mode each additional octave is rotated. With Rotation mode it's easier to see linear noise types.

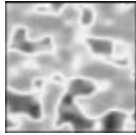

In this example, With Rotation mode was applied to RND Linear noise.

MINIMUM

This mode uses only the lowest values, or darkest areas, to produce the modified noise.

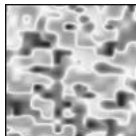

In this example, Minimum mode was applied to RND Continuous noise.

Multiply

In this mode all the values in the noise are multiplied together. The results is a darker noise.

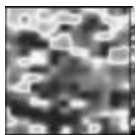

In this example, Multiply mode was applied to RND Continuous noise.

DIFFERENCE

In this mode all the values in the noise are evaluated. All the values that are equal create black areas. When the values are different, the lower value becomes darker. The more octaves you have in the noise, the darker the modified noise. Difference works even at 0 octaves.

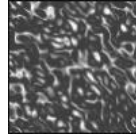

In this example, Difference mode was applied to RND Continuous noise.

MAXIMUM 90

This mode repeats the noise at a 90° angle from its original orientation and combines the original and copy using only the highest values. This mode is good for creating woven patterns.

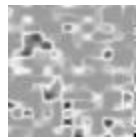

In this example, Minimum 90 mode was applied to RND Continuous noise.

MINIMUM 90

This mode repeats the noise at a 90° angle from its original orientation and combines the original and copy using only the lowest values.

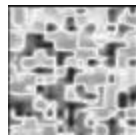

In this example, Maximum mode was applied to RND Continuous noise.

AUTO-PHASED

This mode automatically introduces phase shifts into the noise.

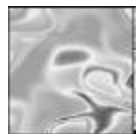

In this example, Auto-phased mode was applied to RND Continuous noise.

Displaced Max

This mode creates a copy of the noise, displaces noise by a small amount, and then lightens any areas where the two overlap. This mode is good for creating stone textures.

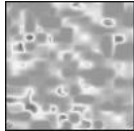

In this example, Displaced Max mode was applied to RND Continuous noise.

PHASE

Phase introduces turbulence into your noise. The phase displaces the grain or patterns within the noise. When you design the phase, you're creating a displacement map along which the noise will be modified.

You can control how the phase interacts with your noise using the Phase palette. You can design your phase using the Phase Editor.

The Phase palette controls the amplitude. The phase amplitude controls the intensity of the displacement. As the amplitude is increased, there is more interference with the original noise.

You won't have to increase the amplitude very much before you start seeing the phase pattern you designed interfere with the existing noise. In fact, it's probably a good idea to keep the phase amplitude low so that the phase pattern doesn't overwhelm the noise.



Original Noise

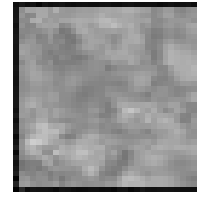

Phase Noise

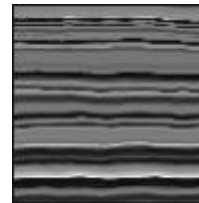

Phase = 10

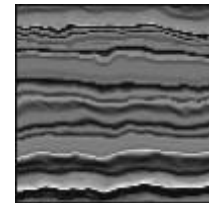

Phase = 30

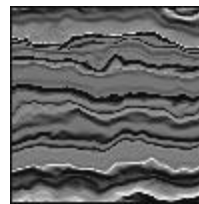

Phase = 50

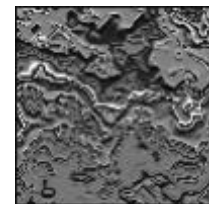

Phase = 250

This graph shows how the phase interacts with the noise at different amplitude settings.

To display the PHASE palette:

- 1 Display the Deep Texture Editor.
- 2 Click the Phase button at the bottom of the editor. The Phase palette appears.
 - Click the Phase button in the bottom-right corner of any of the component windows.

The Phase Editor looks a lot like the Noise Editor. It has the same type of tools and they work exactly like they do in the Noise Editor. The difference is that you're using noise patterns, orientations, frequencies and modes to design how the basic Noise will be displaced.

Using the Phase Editor you can perform several functions:

- Create 1D, 2D, or 3D phase.

- Change the type of noise.
- Change the frequency of the phase.
- Change the orientation of the phase.
- Change the noise octaves.
- Change the noise modulations.

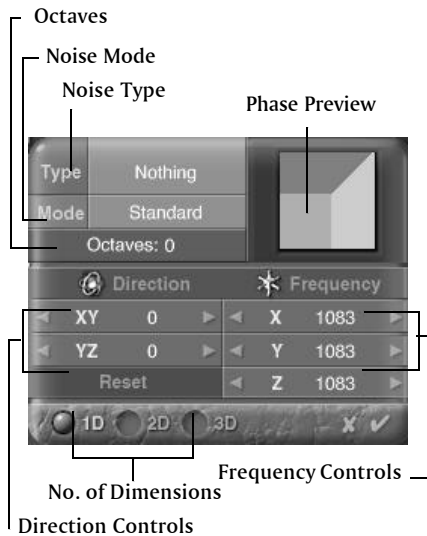

The Phase Editor lets you create noise to use as phase.

While the Phase Editor lets you create the noise pattern or grain within the phase, the Phase palette controls how that phase is applied to the component or the combined texture.

To display the PHASE EDITOR:

- 1 Display the Deep Texture Editor.
- 2 Click the Phase button at the bottom of the editor. The Phase palette appears.
- 3 Click the top left corner of the palette. The corner turns green as you pass your cursor over it.

CREATING PHASE

Phase is designed using the Phase Editor. The phase creation process involves several steps:

- Choose the number of dimensions in the phase.
- Choose a noise type. This gives the basis for creating a phase pattern or grain.
- Adjust the frequency of the noise.
- Adjust the orientation of the noise.
- Apply a modifier to the noise by choosing a Noise Mode.

You'll notice that many of the steps for creating the phase are the same as those for creating noise. That's because you *are* creating noise. The difference is that instead of applying the noise to the texture, the noise you create for the phase is used to displace the existing noise.

The following sections describe the various parts of the editor and how to use them in the noise creation process.

PHASE DIMENSIONS

Just like noise, you can set the dimensions of the phase. The number of dimensions determines which noise axes will be displaced when you apply the phase. For example, if you apply a one-dimensional phase to a three-dimensional noise, only the X axis of the noise will be displaced.

Its easier to see the number of dimensions for your phase if you use a cube in the Phase Preview.



Combined Texture

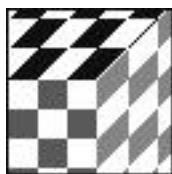

3D Noise

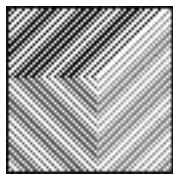

1D Phase

In this example, a 1D phase was applied to a 3D noise.

To choose the number of dimensions for your phase:

- 1 Display the Deep Texture Editor.
- 2 Display the Phase Editor.
- 3 Click one of the dimension buttons at the bottom of the editor.

PHASE NOISE TYPE

There are 27 types of noise available in the Phase Editor. Random Noise is the default (RND).

Each noise type provides you with a different basic pattern for the phase. The noise types available in the Phase Editor are the same as those in the Noise Editor, so you can refer to "Noise Type" on page 178 for more on noise types.

PHASE FREQUENCY

Phase frequency determines how often the pattern within the noise repeats. Frequency is like scaling the noise. Higher frequencies decrease the scale of the noise so you can see the pattern more often. Lower frequencies increase the scale of the noise so the pattern repeats less often.

You can change phase noise frequency using the Frequency numerical fields. The fields let you enter numerical values to adjust the noise frequency along the X, Y or Z axis. You can also adjust the values using the scroll arrows.

The number of dimensions in the phase determines how many axes you can use to adjust the noise frequency. For 1D phase you can only use the X axis. With 2D phase you can use both the X and Y axes. For 3D phase you can use all the axes.

Adjusting the frequency of the Phase noise disproportionately can have some very interesting effects on your noise.



Frequency X=10 Y=80 Z= 10

In this example, the phase noise frequency was changed in only the Y axis and then applied to 3D noise.

To change the frequency of phase noise:

- 1 Display the Deep Texture Editor.
- 2 Display the Phase Editor.
- 3 Drag over the X field in the Frequency area to set the phase noise frequency in the X axis.
Drag left to decrease the value or right to increase it.
- 4 Drag over the Y field in the Frequency area to set the Phase noise frequency in the Y axis.
- 5 Drag over the Z field in the Frequency area to set the Phase noise frequency in the Z axis.

You can also drag over the scroll arrows to speed up the increments.

PHASE NOISE ORIENTATION

Phase noise orientation controls the direction of the noise within the phase.

The number of dimensions in the phase determines how many axes you can use to adjust the orientation.

You can edit the noise orientation using the Direction numerical fields. The fields let you enter precise angles for noise orientation. You can also use the scroll arrows to set the angle in increments.

Like frequency, changing the orientation of the phase noise in only one or two axes can create some very interesting results.



In this example, the phase noise orientation was changed in only the Y axis and then applied to 3D noise.

To change the orientation of phase noise:

- 1 Display the Deep Texture Editor.
- 2 Display the Phase Editor.
- 3 Drag over the XY field in the Direction area to set the noise angle in the X and Y axes.
Drag left to decrease the value or right to increase it.
- 4 Drag over the YZ field in the Direction area to set the noise angle in the Y and Z axes.

You can also drag over the scroll arrows to speed up the increments.

PHASE NOISE OCTAVES

Phase noise octaves work exactly like the noise octaves. They introduce an extra level of complexity to the noise. Refer to “Noise Octaves” on page 180 for more on octaves.

PHASE NOISE MODES

Phase noise modes work exactly like the noise modes. They modify the octaves of a noise. Refer to “Noise Modes” on page 181 for more on octaves.

FILTERING

The filter you apply to the noise in a component can change the entire look of the noise. The filter refines the noise so that it has more or less detail, increases its contrast, applies it only at high altitude or changes its spatial orientation. Whatever the change, the filter has a profound effect on the final look of your texture.

Filters are expressed as equations with variables. When the equation is applied to the noise, it changes some aspect of the noise. You can control how the equation affects the noise by changing the values of the variables.

The filter only affects the noise. The phase cannot be altered using a filter. The phase is blended with the noise.

Filters are edited using the Filtering palette. The palette displays the current filter and provides tools for editing the filter graph.

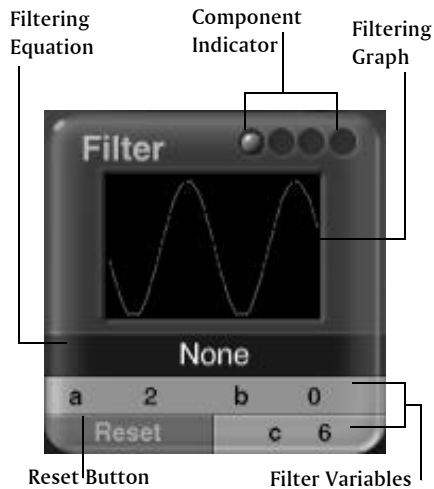

The Filtering palette displays the current filter and provides tools for editing it.

To display the Filtering palette:

- 1 Display the Deep Texture Editor.
 - 2 Click the Filtering button at the bottom of the editor.
- or
- Click the Filtering button in the top-right corner of any of the component windows.

Editing the Filter

Filters are equations which have variables. Each equation can have up to three variables labeled a , b and c . The values for each variable are displayed at the bottom of the palette. Generally, a controls the intensity of the filter effect while b controls the overall height. In some filters a and b may stand for other things.

There are two ways you can adjust a filter: by changing the variable values or by changing the shape of the graph (which automatically changes the variable values). The method you use depends

on how much you know about a particular filter. If you're not sure what the filter does, change the graph—it's a much more intuitive way of working.

To edit the Filtering graph:

- 1 Display the Filtering palette.
- 2 Drag over the Filtering graph area. The shape of the graph changes as you drag.



The graph area of the Filtering palette lets you interactively adjust the filtering effect.

Notice that the variables also changes as you move the graph.

- Dragging horizontally changes the value of a .
- Dragging vertically changes the value of b .

To change variable values:

- 1 Display the Filtering palette.
- 2 Drag over the variable field you want to change. Drag left to reduce the value or right to increase it.

The shape of the graph changes as you adjust the values.

Choosing a Filter

Each filter available in the Filtering palette offers something unique. The best way of choosing which filter you want to use is to apply it to a component and see what happens.

To choose a filter:

- 1 Display the Deep Texture Editor.
- 2 Display the Filtering palette.

- Click the Filtering Equation area and choose a filter from the menu.

There are fourteen filters available. The following sections describe the filters and gives you some idea of how to edit them.

NONE

This option deactivates the filter. No filtering is applied to the component.

QUANTIZE

This filter works like a Posterize effect. When it's applied, gray values jump from one value to the next, creating a blocky stair-step type of effect.

In this filter *a* and *b* control the contrast and height, while *c* controls the number of levels between white and black.



RND Continuous Noise

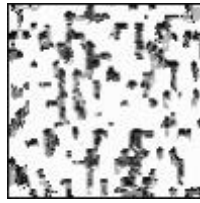

RND Continuous Noise + Quantize

In this example, Quantize was applied to RND Continuous noise.

SAW WAVE

When the graph for this filter has only a small curve, it acts like a contrast filter. As it approaches the height limits (set by *b*), it bounces back on itself. This creates high-contrast breaks in the noise.

For color output use this filter to get areas of high-contrast alternating color.

When you set the value of *a* to a high number you'll get areas with a larger amount of noise.

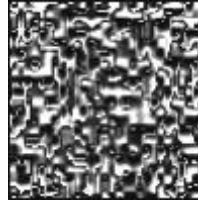

In this example, Saw Wave was applied to RND Continuous noise.

SINE WAVE— $\sin (AX) + b$

This filter creates noise that appears as large number of lines that are oriented in the same direction. Use this filter to generate wood grains.

The *a* variable controls the number of lines. Higher values create a better effect.

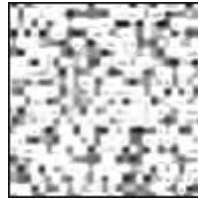

In this example, Sine Wave was applied to RND Continuous noise.

ABSOLUTE— $\text{Abs}(AX + b)$

This filter works like a Difference effect. When it's applied, you'll get more light areas in your noise and a higher level of detail in a bump map.

To get additional bump information using this filter, set *a* to 2 and *b* to -1.

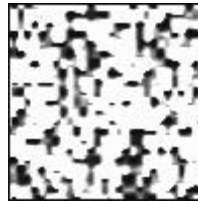

In this example, Absolute was applied to RND Continuous noise.

$$X^{POWER} = (X^{PWR} \cdot a) + b$$

This filter smooths out the darkest areas of your noise. However it has less effect on lighter areas and no effect on white.



In this example, XPower was applied to RND Continuous noise.

$$GAUSSIAN = (a(X + b))$$

This filter smooths out darker areas of your noise and makes lighter areas noisier. White areas become the noisiest.

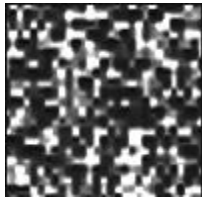

In this example, Gaussian was applied to RND Continuous noise.

$$Clip \ aX + b$$

Clip is probably the filter you'll use most. It's a contrast filter.

The a variable controls the contrast and b controls the overall brightness.

For a low contrast effect make the wave in the graph smaller. Decrease the value of a to reduce the size of the wave and increase b to move the wave up. Using this wave, all the values will be expressed as mid-gray.

For a high contrast effect, adjust the wave so that it hits both the top and bottom edges of the preview. Increase the value of a and make b negative to move the curve down.

To invert the colors in your noise, make a negative and increase b .



In this example, different levels of Clip were applied to RND Continuous noise.

$$Altitude \ Minus \ Slope = Xb + a (Altitude - Slope)$$

This filter applies noise only at certain combinations of slope and altitude. When a is positive and b is negative, noise is applied at high altitudes and on flat surfaces.

When a is negative and b is positive, noise is applied at low altitudes and on steep slopes.

The Altitude Minus Slope filter works on the slope and altitude of an object in World Space.

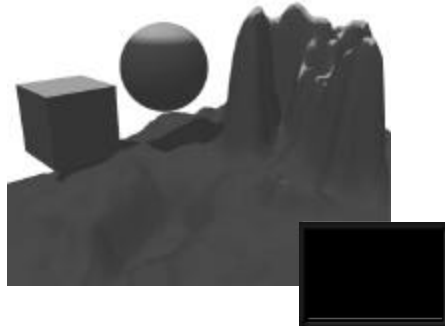

In this example, Altitude Minus Slope was applied to RND Continuous noise and then to objects in a scene.

$$\text{Slope} = X(a * \text{Slope} + b)$$

This filter applies noise based on an object's slope. Slope can range anywhere from flat and horizontal to steep and vertical. This is an excellent filter to use if you want to isolate a texture to vertical cliffs or flat surfaces.

In this filter a determines the steepness of the noise (-4 is flat, 4 is vertical). The b variable controls the starting point of the transition.

- To place noise on vertical surfaces make $a=4$ and $b=2$.
- To place noise on flat surfaces make $a=-4$ and $b=1.5$.

The Slope filter works on the slope of an object in World Space.

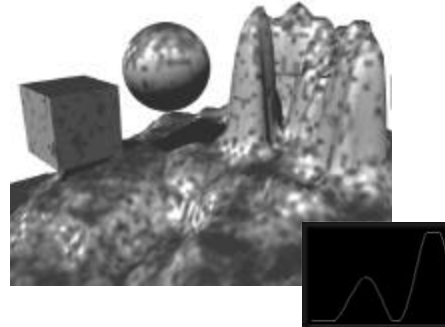

In this example, Slope was applied to RND Continuous noise and then to objects in a scene.

$$\text{Altitude} = X(a * \text{Altitude} + b)$$

This filter modulates the scale of the noise according to an object's altitude.

In this filter a determines how fast the noise is scaled by altitude. A lower value creates a gradual transition, while higher values create sharper transitions.

To apply noise at higher altitudes make sure a is positive. At high altitudes b controls the transition. The higher the transition, the lower the number. So, at high altitudes b should be a negative number.

To apply noise at lower altitude, reverse the variables so that a is negative and b is positive.

The Altitude filter works on the altitude of an object in World Space.

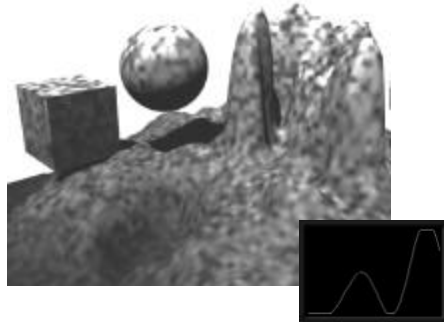

In this example, Altitude was applied to RND Continuous noise and then to objects in a scene.

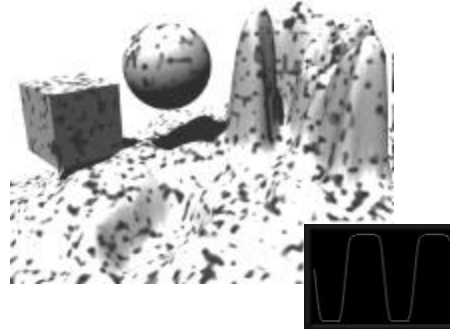

In this example, Smooth Clip was applied to RND Continuous noise.

ORIENTATION— $X(A * \text{ORIENTATION} + b)$

This filter applies noise based on an object's east-west orientation.

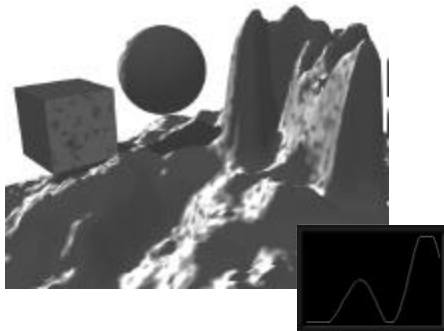

In this example, Orientation was applied to RND Continuous noise and then to objects in a scene.

Snow Puddles

This filter turns noise into snow patches. Snow is applied according to an object's slope and altitude.

The *a* variable controls how much the noise interferes with the smoothness of the snow. When $a=0$ the noise doesn't interfere at all so the snow is perfectly smooth. When the *a* value is higher, the snow starts looking like the noise.

The *b* variable shifts the altitude or snow level. It sets where the snow begins.

The *c* variable controls how steep an object has to be before the snow appears on its surface. The higher the number, the flatter an object has to be before snow appears on its surface.

Smooth Clip

This filter works exactly like the Clip filter. It's also a contrast filter, except that this filter smooths out the transitions between darks and grays.

The *a* variable controls the contrast and *b* controls the overall brightness.

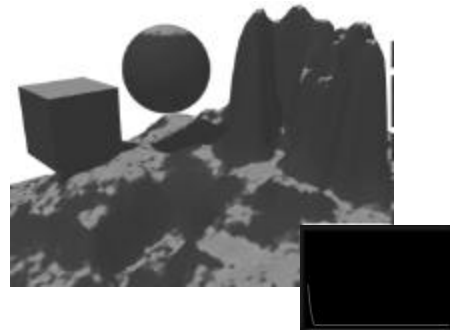

In this example, Snow Puddles was applied to RND Continuous noise and then to objects in a scene.

Combining Components

The Deep Texture Editor gives you unparalleled control over the look and feel of each one of the components that make up a texture, but the control doesn't stop there. The Deep Texture Editor also lets you control how those components are combined to create the final texture.

Blend Modes

Components are combined using Blend modes. These modes are filters applied to the components to determine how the properties in each component are combined with the other components' properties to form the final texture.

The number of blend modes you can use varies depending on how many components you're using to build the texture.

If you're using only one component, the properties in the component are applied directly to the final texture. When you're using two components, they're blended using a single blend mode, and the result is then applied as the final texture.

When you're using three components, the first two components are blended together using a blend mode, then the result of that blend is combined with the third component using a second blend mode. The result of all the blending is then applied as the final texture.

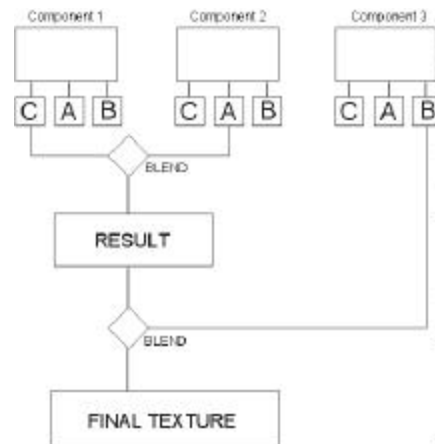

This diagram explains when the blend modes are applied as you combine components to form a texture.

Depending on the Blend mode, the different types of output can affect each other during the combination process. So it's possible that the Bump output of one component may affect the Color output of another.

To apply a blend mode:

- 1 Display the Deep Texture Editor.
- 2 Click the text above a component and choose a mode from the menu.
 - Click the text above Component 1 to choose a Blend Mode to combine components 1 and 2.
 - Click the text above Component 3 to choose a Blend Mode to combine the results of Component 1 and 2 with 3.

There are nineteen blend modes you can use to combine your components:

PARALLEL

This mode does not blend components. Use it when each component has a different output type. If two components share an output type, only the first output will be applied to the final texture.

For example, if Component 1 has output= Color and Bump, and component 2 has output=Color and Alpha, only the color from Component 1 will be applied to the texture.

COMBINE

Combine is a blend mode for colors only. When you use this blend mode, the first color in Component 2 is used as an alpha channel. Wherever that color appears in Component 2, it is replaced with the colors from Component 1.

For example, lets say Component 2 has Yellow, Green and Blue and Component 1 has Orange, Purple and Black as its color scheme.

When you combine them using the Combine blend mode, Yellow disappears from Component 2. Everywhere that Yellow appeared, you'll see Orange, Purple and Black.

AVERAGE

Average is normal blend mode where all the component values are mixed with equal weight. So if one component is white and the other is black, the result is gray.

This is a good all-purpose blend mode to use for creating textures.

Multiply

When you use this blend mode to combine components, you'll get a darker result. In this mode, when a black component is combined with a gray component, the result is black. When a gray component is combined with a white component, the result is gray. When two shades of gray are combined, the result is proportionally darker.

In the case of Bump output, this mode will flatten most areas since black is flat and darker values create flatter bumps.

MAXIMUM

When two components are combined using Maximum, the two components are compared and the one that's lighter becomes the result.

BLEND MAXIMUM

Blend Maximum works the same as Maximum, except that it creates blurring at points of sharp transition.

When Blend Maximum is applied to Bump output, the resulting bump map will have many high points and few deep pits.

This mode works best on Bump output.

MINIMUM

This mode is the opposite of Maximum. When two components are combined, they're evaluated and the darker areas of both are combined to produce the result.

BLEND MINIMUM

Blend Minimum works the same as Minimum except that it creates blurring at points of sharp transition.

When Blend Maximum is applied to Bump output, the resulting bump map will have mostly low areas with very few high points.

Add

Add combines colors so that they appear dramatically lighter. However, it doesn't have the same effect on Bump output.

SUBTRACT

When you combine grayscale components using Subtract, they tend to turn out black or very dark. When you use it with colored components, the result is brilliant colors that tend to compliment the original colors.

BLEND V1 AND V2

These two blend modes let you use one of the components as an alpha channel for blending.

When you choose Blend v1, the noise in the first component is used as an alpha channel to blend the two components.

When you choose Blend v2, the noise in the second component is used as an alpha channel to blend the components.

BLEND SLOPE

Using Blend Slope, components are combined according to an object's slope. The first component is applied to areas that are flat and the other is applied to areas that are steep.

FAST SLOPE

Fast Slope works exactly like Blend Slope except that the transition from one component to the other is more abrupt.

BLEND ALTITUDE

This mode blends components according to an object's altitude. The first component appears at low altitudes and the second appears at high altitudes.

BLEND ORIENTATION

In this mode, one component is applied in all directions, while the other is applied in only one direction. You can use this mode to simulate things like moss that only grow on one side of a tree.

BLEND RANDOM

This mode introduces an extra layer of noise and uses it as an alpha channel for combining the two components. Component 1 appears in some areas of the new noise, and Component 2 appears in other areas.

Since this mode adds another layer of noise, you're also adding more processing time.

PROCEDURAL BLEND

Procedural Blend combines two components so that the color and values of Component 1 are applied to Component 2 based on the gray values in Component 2. In essence, the Alpha output from Component 2 is used as a guide for blending.

Where Component 2 is light, Component 1 is not applied. Where Component 2 is dark, Component 1 is made darker. Where Component 2 is gray, Component 1 is applied without change.

This mode usually results in more saturated colors.

DIFFERENCE

Difference finds the difference between the noise in the two components and displays the result.

This mode only works on output of like types. So if Component 1 has Alpha and Color output while Component 2 has only Alpha, the two Alpha outputs are combined and the Color output is left unchanged.

GLOBAL CHANGES

The component window in the center of the editor, called the Combination component, represents the final combined texture. Any changes you make to this final component are considered global changes since they affect the entire texture.

The Combination component can have its own color scheme, filter, noise pattern or phase. These attributes are applied to all the component elements. For example, the Combination noise values affect the noise within each component.

Global changes give you a way of applying a last layer of complexity to your texture.

Global Colors

The colors in the Combination component interact with the combined colors in the three components. They act as a final color filter for the texture. After the colors in each component are combined, they are blended with the combination component colors to produce the colors in the final texture.

You can also apply a final Color Blending method to the combination component. The Blending method you apply to the combination component is applied on top of the other modes used in the components.

For example, if you choose Altitude in the Combination color is applied using the blend modes in the components and then also applied by altitude.

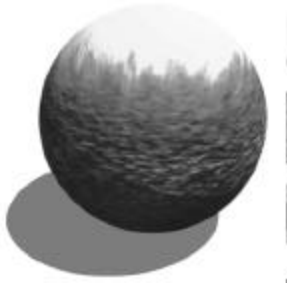

This example shows a texture containing a texture with different Color Blending modes in it.

To add colors directly to a texture:

- 1 Click the top color circle in the Combination component window and choose a color from the palette.



The color circles in the Combination component window let you apply colors directly to the final texture.

- 2 Repeat for each of the other two color circles.

Global Noise

When you change the noise in the Combination component, (i.e., globally) it applies to all the components equally. So if you increase the noise in the final component, the noise in each of the components increases. Likewise, when you decrease the noise globally, the noise in each individual component decreases.

Global noise can be different than component phase, so you can introduce a completely different type of noise into the texture.

Use this option cautiously. The more noise you introduce into your texture, the longer it takes to render and draw. If you introduce too much complex noise patterns into a texture, you may find your render time increased significantly.

You can adjust global noise in the same way you would for a single component, using the Noise palette or the Noise editor.

To adjust noise globally:

- 1 Click the top left button in the combination component window.
The Noise palette appears.
- 2 Drag the slider to adjust the noise value.
or
Click the top left corner of the Noise palette to display the Noise Editor.
Use the editor's controls to design the global noise pattern or grain.

Global Phase

As you adjust the Global Phase value, new phase is introduced into each of the components.

Global phase can be different than component phase, so you can introduce a completely different type of phase into the texture.

You can adjust global phase in the same way you would for a single component using the Phase palette or the Phase Editor.

To adjust phase globally:

- 1 Click the bottom-right button in the combination component window.
The Phase palette appears.
- 2 Drag the slider to adjust the phase amplitude.
or
Click the top left corner of the Phase palette to display the Phase Editor.
Use the editor's controls to design the global phase.

Global Filtering

The Filter affects the final look of the noise within a component. The Global Filter affects the look of the combined noise. The Global Filter is applied to the noise in the Combination component.

The global filter only affects the noise, not the phase in the component. Any of the filters you used in the components can be used as the global filter.

Use this option cautiously. The more complex the noise in your texture, the longer it takes to render and produce. If you introduce too much complexity, you may find your render time increased significantly.

To filter noise globally:

- 1 Click the top-right button in the combination component window.
The Filtering palette appears.
- 2 Choose a filter and adjust its variables to create the desired effect.

THE DEEP TEXTURE EDITOR

The Deep Texture Editor can be used in two ways: by working with equations and algorithms or by exploring and experimenting.

If you're comfortable with equations and algorithms, the Deep Texture Editor gives you the freedom to create any textural pattern or surface you can imagine.

For those who don't want to calculate, the Deep Texture Editor can be used as a large palette. Take a little of this and little of that, blend them all together and see if you like the result. You will find that experimenting with these deep functions can produce unexpected results.

When experimenting with the Deep Texture Editor, you may inadvertently create a very complex texture that could add considerably to your rendering time. However, this is an easy pitfall to avoid. The last section of this chapter gives you some tips on reducing the complexity of your textures. Refer to "Tips for Speeding Up Textures" on page 199 for more.

Tip: When you're just exploring the editor, set all the component outputs to Alpha. This lets you see the effects of your changes more clearly.

To display the Deep Texture Editor:

- 1 Display the Materials Lab.
- 2 Click the A, B or C column of the material channel to which you want to assign a texture.
A component window becomes active.
- 3 Click the pink button at the top of the Component window.
The Deep Texture Editor appears.

A QUICK TOUR: THE DEEP TEXTURE EDITOR

The layout of the Deep Texture Editor is a visual representation of the texture creation process. The three components along the top combine to form the final texture, shown in the middle. The layout makes the editor very easy to use.

Along the top of the editor you'll see the preview options. These three icons let you choose how you want to display the component.

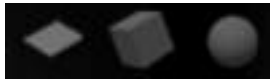

The three icons at the top of the editor let you choose a preview mode.

Below the preview control on the left, you'll see the component selector. This tool lets you choose the number of components you want to use to build your texture.



The component selector lets you choose how many components you want to use to build a texture.

The rest of the editor displays the component window. The three windows along the top represent the three components you can use in a texture and the center window represents the combined texture.

The three buttons along the bottom of the editor let you display the three editing palettes. The palettes let you control the noise, phase and filtering applied to the texture.

You can access the Noise and Phase Editors from within the Noise and Phase palettes.

WORKING IN THE DEEP TEXTURE EDITOR

This section describes how to use the Deep Texture Editor to create and store textures.

BUILDING TEXTURES

A texture is a combination of components. You build textures by designing or editing components (i.e., colors, noise, phase or filters) and combining them using Blend modes.

TO BUILD A TEXTURE:

- 1 Display the Deep Texture Editor.
- 2 Click the Component Selector to choose the number of components you want to use to build the texture.

The component windows become active.
- 3 In the first component window, click one of the Output buttons to choose an output type.
- 4 If your component contains color, click one of the color circles and choose a color to apply to the texture.

You can choose up to three colors for each component.
- 5 Click the triangle icon below the color circles and choose a Color Blending mode for your colors.
- 6 Click the Noise button at the bottom of the editor. The Noise palette appears.
- 7 Adjust the noise in the component by:
 - Dragging the Noise slider on the Noise palette to increase or decrease the amount of noise in the component.
 - Click the top left corner of the palette to display the Noise editor, then use the editor controls to design or edit the noise in the component.
- 8 Click the bottom-right button on the Component window. The Phase palette appears.
- 9 Adjust the phase in the component by:
 - Dragging the Phase slider on the Phase palette to increase or decrease the amplitude of the phase in the component.

- Click the top left corner of the palette to display the Phase editor, then use the editor controls to design or edit the phase in the component.
- 10 Click the Filtering button at the bottom of the editor. The Filtering palette appears.
 - 11 Choose a filter to apply the component noise and adjust that filter's variables.
 - 12 Repeat steps 3–11 for each component in the texture.

As you edit the noise, phase, or filter of the remaining components, make sure you move the component indicator at the top of each palette to be sure you're editing the right component's attributes.
 - 13 Click the text above Component 1 and choose a Blend mode from the menu.
 - 14 If you have more than two components, click the text above Component 3 and choose a second blend mode.

The result of blending all the components appears in the Combination window.
 - 15 Click the color circles in the Combination component window, and choose colors for the final texture.

You can also choose a Blending mode.
 - 16 If you want to change the noise of combined component, display the Noise palette.

If it's already displayed, make sure the component indicator is on the fourth component.
 - 17 If you want to change the phase of combined component, display the Phase palette.

If it's already displayed, make sure the component indicator is on the fourth component.
 - 18 If you want to change the filter of combined component, display the Filtering palette.

If it's already displayed, make sure the component indicator is on the fourth component.

- 19 Click the OK icon at the bottom of the editor. The texture appears in one of the component windows in the Materials Lab.

USING DRAG AND DROP IN THE EDITOR

The Deep Texture Editor lets you drag and drop component elements between component windows. This a quick way of copying elements between components.

For example, if you were setting up a red, green and blue separation of the colors in your texture, you could drag the same elements to all three component windows and change the Color Blending mode.

To drag and drop between windows:

- Drag from the window you want to copy to the window where you want the elements to appear. Release the mouse button to drop the component elements.

The elements you drop into a window replace the existing elements.

CHANGING COMPONENT PREVIEW

Each component window has a preview of the component's elements. You can choose to display the elements mapped onto a flat surface, a cube or a sphere.

Displaying the component on a cube makes it easier to see 3D noise and phase changes.

To choose a preview mode:

- Click the flat surface, cube or sphere in the top-right corner of the editor.

RANDOMIZING TEXTURES

A quick way of designing a texture without going into designing noise or filters is to create random components.

The randomize buttons in the component windows let you randomize the elements in the component window. The type of output you choose for the component determines what part of the component is randomized.

This is an excellent way of exploring the editor. Just randomize the components elements and combine them to see what happens.

TO RANDOMIZE COMPONENT ELEMENTS:

- Click the knob in the bottom-right corner of the component window.

UNDOING CHANGES

The Reset control lets you undo all the changes you've applied to a component and returns to the component displayed when you first entered the editor.

TO RESET A COMPONENT:

- Click the knob in the top-left corner of the component window.

SAVING TEXTURES

You can save your texture as part of texture list so you can access it quickly from the Materials Lab.

TO SAVE A TEXTURE:

- 1 In the Combination component window, click the knob in the top-right corner of the component window.
The Save Texture dialog appears.
- 2 Enter a name for the new texture and click the OK icon.

The new texture appears at the bottom of the texture list. The list can be accessed from the Materials Lab.

TIPS FOR SPEEDING UP TEXTURES

Textures can be the most powerful effects you create in Bryce. They can also be the most costly. The more complex the texture, the longer it takes to calculate and the longer it takes to apply to an object, which finally increases the rendering time.

When you're creating the texture, you always have to keep in mind that it's part of a material, which is part of an object. All these parts can contribute to the rendering time:

- The material that contains the texture may have several complex attributes of its own, like Transparency and Reflection.
- The size of the object may also contribute to the rendering time.

Consider the effect of applying a complex texture to a complex material onto an infinite plane. The time to calculate this object would be staggering.

A good rule of thumb when working with complex objects and textures is to make the texture element as simple as possible.

These tips are meant only as a precaution to prevent you from inadvertently creating a huge texture. That doesn't mean that you shouldn't use the more complex features as well, after all they were created for a reason. You should just use them cautiously.

Noise

- Use a simpler noise type. Some noise types (like Vortex) require more time to process than others.
- Restrict the amount of noise you add to each component. In fact, not all the components need to have noise.

- Watch the frequency of the noise. Higher frequency noise requires more time to calculate than lower frequency noise.
- Watch the number of octaves in the noise. Each octave adds another level of complexity.

PHASE

- When you're designing the phase, you may want to use simpler noise.
- Cut down on the number of phase types you combine. If each component has a different type of phase, combining them can increase calculation times.
- Watch the amplitude of the noise. Higher amplitude phase takes much longer to calculate.
- Apply Global Phase cautiously. This is the quickest way of increasing the complexity of your texture because global phase introduces more complexity into each component simultaneously.

FILTERING

- Filtering introduces complexity or detail into the noise of a component. Make sure that you aren't using a filter unnecessarily. Not all noise needs filters.

Be careful when you apply a Global Filter as this adds even more complexity to the noise.



9

ARRANGING OBJECTS

In a scene, the arrangement of objects is as important as their form. You can design beautiful landscapes, or build complex models, but if they're the wrong size or in the wrong position, they won't look right in the scene. To get the right look, you'll need to position or rotate the objects to make sure they are in the right places within the scene, or you may need to resize an object so that it is in proportion to the rest of the objects. These kinds of operations are called *transformations*.

Bryce supports three basic types of transformations: size, position, and rotation. The tools in the Edit palette let you interactively perform these operations on any object in your scene. As well, the Object Attributes dialog lets you transform objects numerically for greater precision.

As you arrange objects, you'll probably need to create some kind of object hierarchy. An object hierarchy lets you create a structure in your scene that organizes objects according to their spatial or logical relationships. The structure can make arranging objects much easier and faster.

You can create an object hierarchy by grouping and linking objects.

This chapter describes how to use the transformation tools and the Object Attributes dialog to resize, reposition, rotate, align and randomize objects. It also describes how to create object hierarchies.

BRYCE AND 3D SPACE

Since all the objects in your scene exist in 3D space (defined by XYZ), any transformation you perform is a 3D transformation. This means that you're changing the attributes of the object in each axis.

Bryce has three ways of defining 3D space: World Space, which is constant, Object Space, which changes as the object changes and Camera Space, which changes as the camera changes.

When you're using the interactive transform tools on the Edit palette you can use any one of the 3D space definitions. Refer to "Transformation Tools" on page 206 for more on using these tools.

World Space

World Space is the coordinate system that defines all the space in the Bryce universe. It is constant and cannot be modified. It is also the default space used for transformations.

World Space is defined by three axes, X, Y and Z, that all meet at world center. This center is defined numerically as 0, 0, and 0 for the X, Y and Z axes. By default, all new objects appear at world center.

The Y axis that extends from world center defines all vertical space. Positive values represent distances above ground level and negative values represent distances below ground. The X axis represents distances left and right and the Z axis represents distances backward and forward.

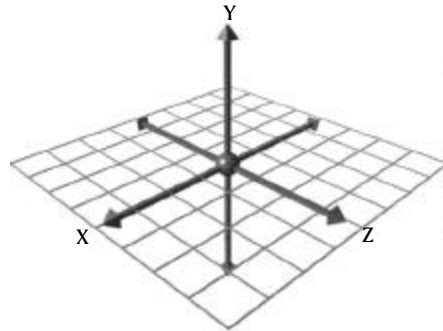

World Space is defined by three axes that extend infinitely from a center point called world center.

When you use World Space for transformations, objects move in relation to this absolute coordinate system.

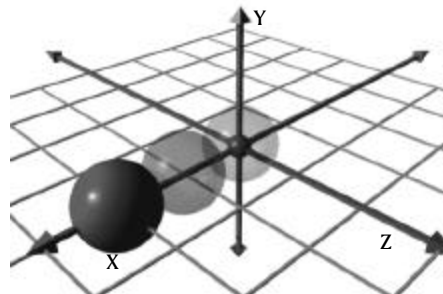

When you transform objects in relation to World Space, they move along the three absolute axes.

Object Space

When Bryce creates an object, it defines the up, down, right, left, back and front of the object. These definitions remain with the object no matter what transformations you apply to it. So in a sense, each object carries with it its own coordinate system.

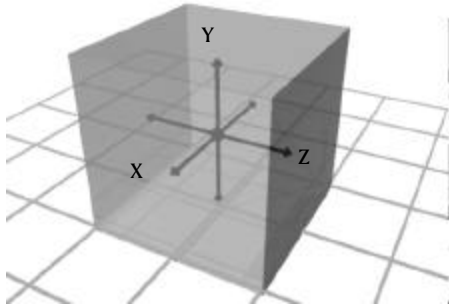

Object space is defined by three axes that extend from the center of the object.

When you transform an object using Object Space, the object moves in relation to its internal coordinate system. For example, you can increase the height of an object based on its own Y axis.

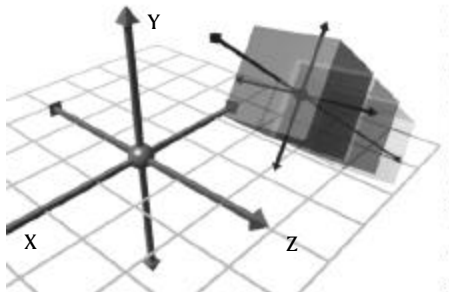

When you transform an object using Object Space, it moves along an axis that extends from its center, not an absolute axis.

Because Object Space ignores the absolute coordinates, the object becomes taller without being skewed. If you used World Space, the object would become deformed since it increases along the absolute Y axis.

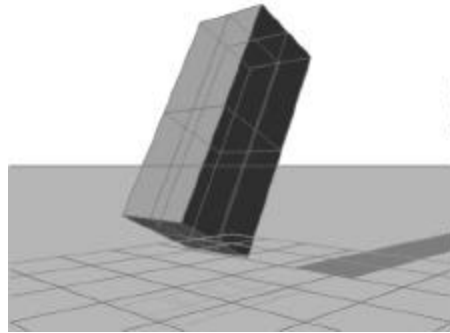
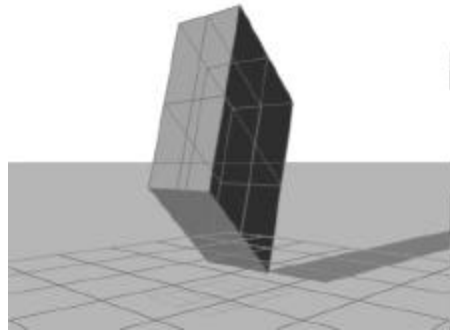

This is an example of an object transformed using World Space and then using Object Space.

CAMERA SPACE

Camera Space is defined by three axes, X, Y and Z, that extend from the camera center. Wherever you move the camera, these axes move along with it.

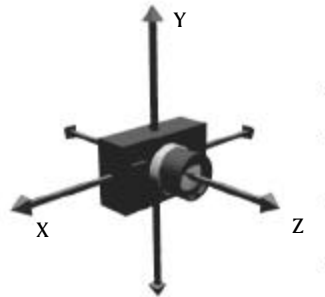

Camera Space is defined by three axes that extend from the center of the camera.

When you use Camera Space for transformations, you're moving objects in relation to the camera. When you drag along the X axis in Camera Space, you're moving left or right from the camera. When you move along the Y axis in camera space, you're moving up or down from the camera. When you move along the Z axis, you're moving away or towards the camera.

Since the camera can be rotated and repositioned, it can sometimes be hard to tell which way is up, left or right, because your view from the camera is no longer aligned to the absolute XYZ axes.

Suppose you've rotated the camera and then you move an object along the Y axis in World Space. Instead of moving up, it may appear to move off to the left, since your view of the scene is not aligned to the World Space Y axis. However, in Camera Space, the object will move up, because the object moves along the camera's Y axis.

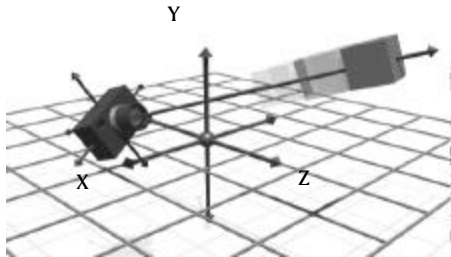

When you transform objects using Camera Space, they move along an axis that extends from the center of the camera.

To choose a 3D spatial option for transformations:

- 1 Click the Edit button at the top of the Bryce window to display the Edit palette.
- 2 Click the triangle icon below one of the transformation tools and choose a 3D spatial option from the menu.



Each of the transformation tools has a triangle icon below it, which lets you access additional tool options.

BRYCE UNITS

Bryce maintains an invisible, absolute, infinite 3D grid internally. This grid is comprised of 3D cube increments, each of which is 20.48 x 20.48 x 20.48 "Bryce units" in size. All primitive objects (spheres, cubes, etc.) are created at the same size as a 3D cube increment (20.48 x 20.48 x 20.48) called *unity*.

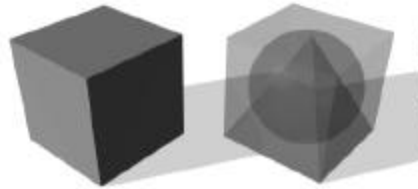

Unity is the base size of all primitive objects created in Bryce. Unity is always 20.48 x 20.48 x 20.48.

All interactive 3D transformations are relative to an absolute (unity) size, position, and orientation for all objects.

To RESET PRIMITIVE OBJECTS TO UNITY:

- Hold down Control/Ctrl+Option/Alt and click one of the object's control points. The object is reset to 20.48 x 20.48 x 20.48.

COORDINATE SYSTEMS

When you're transforming objects numerically in the Object Attributes dialog, you can use one of two coordinate systems: Absolute Coordinates or Definition Coordinates.

ABSOLUTE COORDINATES

Absolute Coordinates use the World Space axes as the reference for object transformations. When you enter transformation values using Absolute

Coordinates, you're defining how the object is transformed along the World Space, or absolute, X, Y, and Z axes.

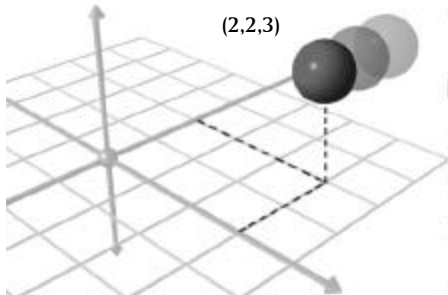

Absolute Coordinates use the World Space axes as reference, so you're repositioning the object along the absolute X, Y, and Z axes.

DEFINITION COORDINATES

Definition (Object Space) Coordinates define how an object is actually created. In object space, the origin of the object is located at $X=0, Y=0, Z=0$. All the other points in the object are defined by coordinates along the object's internal X, Y and Z axes.

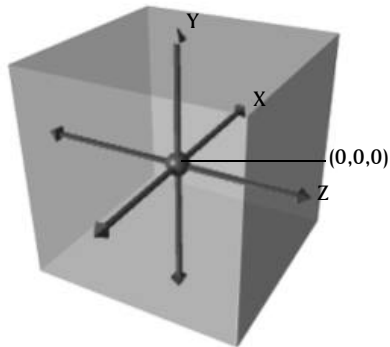

Definition Coordinates define how an object is created. The origin is at $0, 0, 0$, while all the other points that define the object's shape and size are coordinates along the X, Y and Z-axes within the object.

This coordinate system uses the object's internal axes as a reference for transformations. When you enter transformation values using this system, you change how the object is defined to include the position of its origin, its size, and orientation.

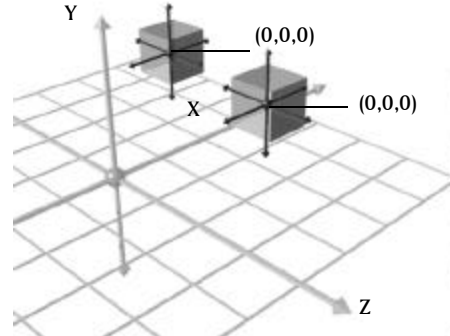

Definition Coordinates use the object's internal axes as reference, so you're redefining the object's position along its internal X, Y, and Z axes.

In Definition transformations, the origin point of the object always remains at Object Space $0, 0, 0$. As you move or scale the object, it changes, moves or grows along its internal axes, but the origin remains at $0, 0, 0$. This can cause some unpredictable results. For example, if you scale an object using Definition Coordinates, the origin point will no longer be in the exact center of the object. When you rotate the object, it won't rotate around its center.

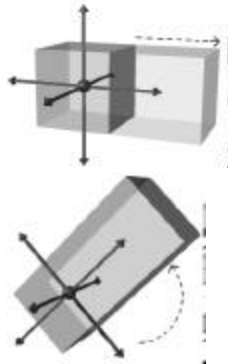

In this example, an object was scaled using Definition Coordinates and then rotated. You can see that it no longer rotates around its center.

Transforming using Definition Coordinates is not the same as using Object Space with one of the Transformation tools. When you choose Object Space for one of the transformation tools, transformations are performed using Object Space axes as a reference, but the final position, or size, is calculated using Absolute Coordinates. So in this case the object origin and all its points move along with the object.

When you use Definition Coordinates to transform an object, you're redefining how the object is created, so its origin does not change as the size and position change.

RELATIVE COORDINATES

Relative Coordinates use the World Space axes as reference for object transformations, but the values represent changes relative to the object's current position, or size. For example, if you enter a position change of 2 units, the object moves two units from its current position along one of the World Space axes

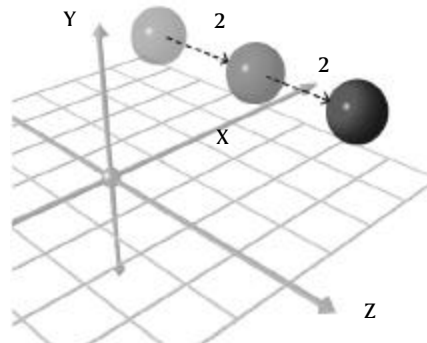

Relative Coordinates use the World Space axes as reference, but transformations are relative to the current position or size of the selected object.

Relative Coordinates is the only coordinate system available in the 3D Transformation dialog.

TRANSFORMING OBJECTS

TRANSFORMATION TOOLS

The transformation tools let you perform all the object transformation operations available in Bryce. The tools act as interactive controls. As you drag over the tool, the operation is performed on the selected object.

The transformation tools are located on the Edit Palette.

TO SELECT A TOOL:

- 1 Click the Edit button at the top of the Bryce window to display the Edit palette.
- 2 Select an object.
- 3 Drag over the tool to perform a transformation operation.

RESIZE TOOL



Use the Resize tool to resize objects along one or all of the three axes.

ROTATE TOOL



Use the Rotate tool to rotate objects in 3D space.

REPOSITION TOOL



Use the Reposition tool to reposition objects along any of three axes.

ALIGN TOOL



Use the Align tool to align objects along their tops, bottoms, left sides, right sides, fronts, backs or centers.

RANDOMIZE TOOL



Use the Randomize tool to scatter or disperse objects in 2D or 3D space.

OBJECT ORIGIN POINTS

Every object in Bryce has an origin point. This point defines the object's center of rotation.

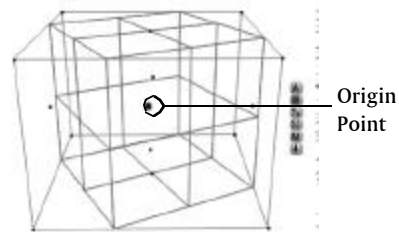

The object's origin point defines the object's center of rotation.

In the Working window, the origin point appears as a small green dot. By default the origin point appears at the center of the object's bounding box. You can adjust the position of the origin point to any point along the object's surface or outside of the object.

Where you place the origin point depends on the effect you want to create. For example, if you rotate an object when its origin point is at its center, it spins in place. When the point is placed outside the object, it rotates around the origin point like a planet around the sun.

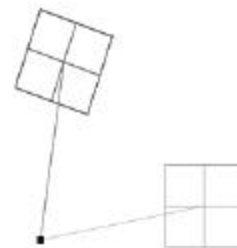
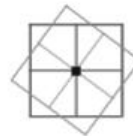

When the origin point is at the center of the object it rotates in place. When you move the origin point outside the object, it orbits around its point.

To display the origin point:

- Enable Show Origin Handle in the General tab of the Object Attributes dialog box.

To reset the origin point to the default position:

- Hold down Shift while clicking on the origin point of an object.

To set the origin point to the averaged center of objects in the scene

- 1 Select the objects for which the averaged center is to be determined.
- 2 Hold down Command/Ctrl+Shift while clicking on the origin point of a selected object.

To cause the origin point to stay in position while the object moves

- Drag the object, and then hold down the spacebar as you continue to drag the object to a new position.

NANO-Edit Mode

Nano-Edit Mode activates the Nano-Editor which lets you perform camera transformations on a small preview of your scene, instead of the full scene.

When this mode is active, the Nano-Editor appears any time you perform a camera transformation. The Nano-Editor window displays a small preview of your scene. The transformation is applied to the preview. When you close the editor, the transformation is applied to the full scene.



Use the Nano-Edit mode to quickly see the effects of transformation on a preview of your image.

This mode is useful when you're working on a large scene, as it saves on redraw time.

To activate NANO-Edit Mode:

- 1 Click the Nano-Edit button on the Display palette.



When the smaller square inside the icon (which represents an active Nano-Editor) is red, the Nano-Edit Mode is on; when it is white, it is off.

- 2 Reposition the camera using the Camera controls.

To temporarily activate NANO-Edit Mode:

- Hold down Option/Alt+Spacebar before you perform transformations. The Nano-Editor appears only during the operation.

RESIZING OBJECTS

When you create an object, it appears at a default size. Once you place it in your scene, you may need to resize it to make it proportional to the other objects in your scene.

There are three ways of resizing objects in Bryce:

- using the Resize tool, in the Edit palette, to resize an object along different axes
- using the 3D Transformation dialog which lets you enter precise values to resize objects
- using the control points on the object's bounding box to interactively resize the object

Objects are measured in Bryce units. When you resize an object, you're increasing or decreasing its size based on unity size. When you resize an object to 150%, you're sizing it to 150% of unity. Refer to "Bryce Units" on page 204 for more.

Using the RESIZE TOOL

The Resize tool lets you resize a selected object along any axis. Objects are resized from their origin point.

The Resize tool has seven different states. As you move the pointer over the tool each state becomes active.

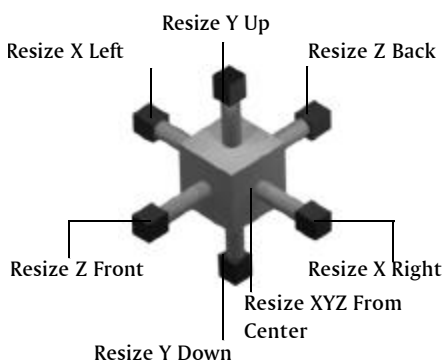

The Resize tool has seven states. As you move your cursor over the tool each state becomes active.

The different states let you resize the object along different axes. Resizing along the Y axis increases/decreases the object's height. Resizing along the X axis increases/decreases the object's width. Using the Z axis for resizing increases/decreases the object's depth.

To RESIZE AN OBJECT ALONG A SPECIFIC AXIS:

- 1 Make sure the Edit palette is visible. If it's not, click the Edit text button at the top of the Working window.
- 2 Move the cursor over the Resize tool.
- 3 When the state you want to use becomes active, drag to resize the object.

For example, if you're using Resize Y Up, drag to the right to increase the object's height in the Y axis. The more you drag, the taller the object becomes.

Hold down Shift to constrain the resize increments to 50% intervals when increasing the size of the object.

To RESIZE AN OBJECT IN ALL DIRECTIONS:

- 1 Make sure the Edit palette is visible. If it's not, click the Edit text button at the top of the Working window.
- 2 Click the center of the Resize tool and drag right to increase the size of the object, or left to decrease it.

To RESIZE AN OBJECT FROM TWO DIRECTIONS ALONG A SINGLE AXIS:

- 1 Make sure the Edit palette is visible. If it's not, click the Edit text button at the top of the Working window.
- 2 Move the cursor over the Resize tool.
- 3 When the state you want to use becomes active, hold down Option/Alt and drag in the direction you want to resize the object.

For example, if you're using Resize Y Up, when you hold down Option/Alt as you drag, the object becomes longer both up and down along the Y axis.

Objects can be resized using any of the three spatial definitions (World, Object or Camera). The definition you choose depends on the effect you wish to create.

To choose a spatial option for resizing:

- 1 Make sure the Edit palette is visible. If it's not, click the Edit button at the top of the Bryce window.
- 2 Click the triangle icon next to the Resize tool and choose an option from the menu.
- 3 Object Space resizes your selection relative to itself (see "Object Space" on page202).
World Space resizes your selection in absolute world coordinates (see "World Space" on page202).
Camera Space resizes your selection relative to the camera (see "Camera Space" on page203).

When you set Object, World, or Camera Space for the Resize tool, it is also the option set for the other two transformation tools. However, spatial options are global for the transformation tools only. The option you select in the Edit palette does not affect the 3D Transformations dialog.

Flipping Objects

Flipping is not the same as rotating an object 180°. Flipping mirrors an object along an axis instead of rotating it.

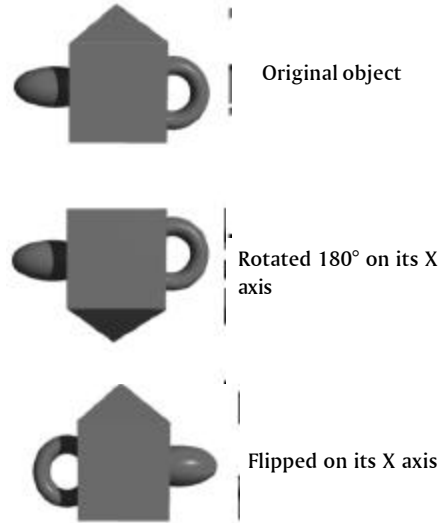

This example shows an object that has been rotated 180° and the same object flipped on its X axis.

To flip an object:

- 1 Make sure the Edit palette is visible. If it's not, click the Edit button at the top of the Bryce window.
- 2 Click the triangle icon next to the Resize tool and choose a flip option from the menu:
Flip X inverts your object's dimensions along the X axis.
Flip Y inverts your object's dimensions along the Y axis.
Flip Z inverts your object's dimensions along the Z axis.

To undo resize operations:

- 1 Make sure the Edit palette is visible. If it's not, click the Edit button at the top of the Bryce window.
- 2 Select an object.
- 3 Click the triangle icon next to the Resize tool and choose Unscale from the menu.

NUMERICAL RESIZING

Sometimes you will need more precise control over the size of your object. The 3D Transformations dialog lets you enter specific resize values for a selected object.

All transformations you enter in this dialog are performed in World Space regardless of the spatial option you chose for the Resize tool.

Resize values are expressed as a percentage of the current size of the selected object. You cannot enter negative numbers in this dialog.

TO RESIZE AN OBJECT NUMERICALLY:

- 1 Make sure the Edit palette is visible. If it's not, click the Edit button at the top of the Bryce window.
- 2 Select an object.
- 3 Click the triangle icon below the Resize tool and choose 3D Transformations from the menu. The 3D Transformations dialog appears.
- 4 Enter a percentage in one or all of the axis fields.

The percentage determines the new size of the object based on its original size. For example, to double the object's size in all directions, enter 200 in the X, Y, and Z fields. To resize along a single axis, enter values in only one axis field.

Since you are dealing with World Space transformations in this dialog, if you resize an object along only one or two axes you may unintentionally skew the object's shape.

To resize the object without skewing it, use the numeric entry fields in the Object Attributes dialog. Using this dialog can resize the object based on its original position, with no unintentional skewing. Refer to "Definition Coordinates" on page 205 for more.

INTERACTIVE RESIZING

While you can resize objects using the Resize tool or the 3D Transformation dialog, there are resize controls on the object's bounding box that let you resize objects directly in the Working window. You may find this a much more intuitive way of transforming your objects.

When you select an object, a bounding box appears surrounding your selection. At each corner of the box, and at the center of each face, is a control point.

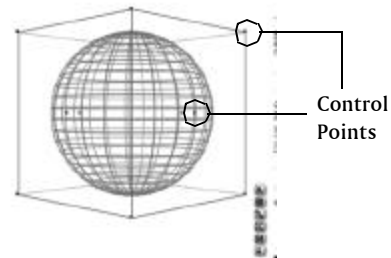

An object's bounding box has control points at the corners and at the center of each face that can be used to resize the object.

As your cursor passes over the corner control points, it changes to a generic Resize cursor. As it passes over the control points on the faces, it changes to an X, Y or Z. This indicates the axis along which you can resize the object by clicking and dragging at that point.



The corner control points resize the object along all three axes. The control points on the faces of the bounding box resize the object along a single axis.

TO RESIZE AN OBJECT ALONG A SINGLE AXIS INTERACTIVELY:

- 1 Select an object.

- 2 Drag one of the control points at the center of a bounding box face.

As you pass your cursor over the face, the cursor changes to an X, Y or Z to indicate the axis you're resizing along.

To ENLARGE OR SHRINK AN OBJECT INTERACTIVELY:

- 1 Select an object.
- 2 Drag one of the control points on the corners of the bounding box.

Drag right to enlarge it, or left to shrink the object.

- Hold down Command/Ctrl while dragging to resize in the opposite direction from the selected corner point.
- Hold down Option/Alt while dragging to resize from the center of the object.
- Hold down Shift to constrain resizing to 50% increments.

To RESIZE AN OBJECT FROM THE BOTTOM CENTER:

- 1 Select an object.
- 2 Click the Y face control point and hold down the mouse button, then press Command/Ctrl+Option/Alt and drag the point.

The object resizes in all directions from the bottom center of the object. This transformation may be useful if the object is on the ground and you want it to remain there.

Using THE KEYBOARD

You can also use the keyboard keys to resize objects:

Press * to double a selected object's size.

Press / to halve a selected object's size.

Press = to return the object to unity size and snap it to the Grid.

ROTATING OBJECTS

Most objects have a specific up, down, left, right, back and front associated with them when you create them. When you place the object in a scene, its orientation may need to be altered to achieve a desired effect. For example, an airplane that's taking off should be tilted upwards, or tilted downward when it's descending.

There are three ways of rotating objects in Bryce:

- using the Rotate tool to rotate an object along different axes
- using the 3D Transformation dialog, which lets you enter precise rotation angles
- using the object's control points to interactively rotate the object

Using THE ROTATE TOOL

The Rotate tool lets you rotate a selected object along any axis. Objects can be rotated in World Space, Object Space or Camera Space.

The Rotate tool has three states. As you move the cursor over the tool, one of the states becomes active.

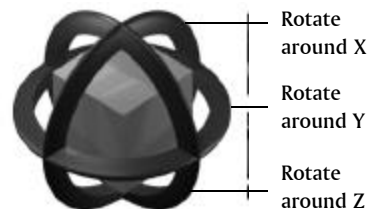

As you move your cursor over the tool a rotation state becomes active.

To ROTATE AN OBJECT AROUND AN AXIS:

- 1 Make sure the Edit palette is visible. If it's not, click the Edit button at the top of the Bryce window.
- 2 Move the cursor over the Rotate tool.

- 3 When the state you want to use becomes active, drag in the direction you want to rotate the object.
Hold down Shift while dragging to constrain rotation operations to 45 degree increments.

To choose a spatial option for rotation

- 1 Make sure the Edit palette is visible. If it's not, click the Edit button at the top of the Bryce window.
- 2 Click the triangle icon next to the Rotate tool and choose an option from the menu:

Object Space rotates your selection relative to itself (see "Object Space" on page202).

World Space rotates your selection in absolute world coordinates (see "World Space" on page202).

Camera Space rotates your selection relative to the camera (see "Camera Space" on page203).

The three spatial options are also available for the Resize and Reposition tools. When you select Object, World, or Camera space for the Rotation tool, it is also set for the other two tools. The option you choose in the Edit palette does not affect the 3D Transformations dialog.

To undo rotation operations:

- 1 Make sure the Edit palette is visible. If it's not, click the Edit button at the top of the Bryce window.
- 2 Click the triangle icon next to the Rotate tool and choose Unrotate from the menu.

NUMERICAL ROTATION

In a complex scene, orienting objects may require more precision than the Rotation tool offers. The 3D Transformations dialog lets you enter specific rotation angles for a selected object.

All transformations performed using this dialog use World Space coordinates regardless of the spatial option you chose for the Rotate tool.

Rotation values are expressed as degrees, with 360° being a single full rotation. Since rotations are relative, you may enter negative values and cumulative values (greater than 360° or less than -360°).

To rotate an object numerically:

- 1 Make sure the Edit palette is visible. If it's not, click the Edit button at the top of the Bryce window.
- 2 Select an object.
- 3 Click the triangle icon next to the Rotate tool and choose 3D Transformations from the menu. The 3D Transformations dialog appears.
- 4 Enter a degree value in one or more of the Rotate fields.

The degrees determine the angle of rotation. For example, to rotate an object 45° around Y, enter 45 in the Rotate Y field. To rotate around other axes, just enter values in the appropriate fields.

Since you're dealing with World Space transformations, objects are rotated with respect to the World Space X, Y, and Z axes.

You can also rotate an object numerically using the Object Attributes dialog. The values in the Attributes dialog rotate the object using either Absolute coordinates or Object Space coordinates. Refer to "Absolute Coordinates" on page204 and "Definition Coordinates" on page205 for more on these coordinate systems.

INTERACTIVE ROTATION

Using the control points on an object's bounding box, you can freely rotate an object directly in the Working window.

Rotation control points appear when you hold down Command /Ctrl and pass your cursor over the object's bounding box. The corner control points let you free-rotate your object. The control points at the center of each face rotate the object along a single axis.

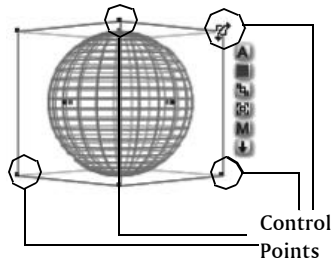

An object's bounding box has control points at the corners and at the center of each face that can be used to rotate the object.

To ROTATE AROUND A SINGLE AXIS:

- 1 Select an object.
- 2 Hold down Command /Ctrl and drag on any face control point.

You can tell which axis you're rotating around by releasing the Command /Ctrl key for a moment. The cursor changes to an X, Y or Z.

To FREE ROTATE AN OBJECT:

- 1 Select an object.
- 2 Hold down Command /Ctrl and drag on any corner control point.

Holding down Option/Alt while dragging on a corner control point lets you rotate the object in very fine increments.

POSITIONING OBJECTS

The composition of your scene depends on the position of the objects relative to other objects. In most cases, you'll need to use the Reposition tool in conjunction with the Resize and Rotation tools to create the desired relationships.

Positioning applies to objects, groups and families as well as lights and the camera. In this section the term "object" also refers to the camera and lights.

Bryce lets you position objects in four ways: using the Position tool to move objects along a specific axis; using the 3D Transformation dialog to enter specific offset positions, by dragging the object to a different location; or by using the arrow keys to nudge objects.

Using THE REPOSITION TOOL

The Reposition tool has three different states: Reposition X, Reposition Y, and Reposition Z. As you move the pointer over the tool, one of its states becomes active.

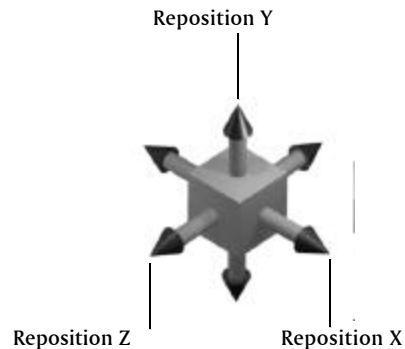

The Reposition tool has three states. As you move your cursor over the tool, a state becomes active.

To position AN OBJECT ALONG A SPECIFIC AXIS:

- 1 Make sure the Edit palette is visible. If it's not, click the Edit button at the top of the Bryce window.
- 2 Move the cursor over the Reposition tool.
- 3 When the state you want to use becomes active, drag in the direction you want to move the object.

To choose a spatial option for repositioning:

- 1 Make sure the Edit palette is visible. If it's not, click the Edit button at the top of the Bryce window.
- 2 Click the triangle icon next to the Reposition tool and choose an option from the menu:

Object Space moves your selection relative to itself (see "Object Space" on page202).

World Space moves your selection in absolute world coordinates (see "World Space" on page202).

Camera Space moves your selection relative to the camera (see "Camera Space" on page203).

The three spatial options are also available for the Resize, and Rotate tools. When you select Object, World, or Camera Space for the Rotation tool, it is also set for the other two tools. The option you choose in the Edit palette does not affect the 3D Transformations dialog.

To undo position operations:

- 1 Make sure the Edit palette is visible. If it's not, click the Edit button at the top of the Bryce window.
- 2 Click the triangle icon next to the Reposition tool and choose Unreposition from the menu.

NUMERICAL REPOSITIONING

The most precise method of positioning objects is by using the 3D Transformations dialog. This dialog lets you enter specific offset values for a selected object.

All transformations performed using this dialog use World Space coordinates regardless of the spatial option you chose for the Reposition tool.

Offset values are expressed in Bryce units of measure (refer to "Bryce Units" on page204). You may enter negative numbers in the Reposition fields.

To reposition an object numerically:

- 1 Make sure the Edit palette is visible. If it's not, click the Edit button at the top of the Bryce window.
- 2 Select an object.
- 3 Click the triangle icon next to the Reposition tool and choose 3D Transformations from the menu. The 3D Transformations dialog appears.
- 4 Enter a value in one or all of the Offset fields.

The value determines the number of Bryce units the object is offset from its current position.

Remember that since this dialog only performs transformations in world space, you are moving the object relative to world X, Y, and Z coordinates.

You can also position an object numerically using the Object Attributes dialog. The values in the Attributes dialog position the object using either Absolute coordinates or Object space coordinates. Refer to "Absolute Coordinates" on page204 and "Definition Coordinates" on page205 for more on these coordinate systems.

INTERACTIVE REPOSITIONING

The simplest way of positioning objects is by dragging them to different locations in your scene.

When you drag an object, you're repositioning it with respect to the camera.

To reposition an object interactively:

- Drag the object to a new location.
 - Hold down X while dragging to constrain movement to the X axis.
 - Hold down Y while dragging to constrain movement to the Y axis.
 - Hold down Z while dragging to constrain movement to the Z axis.

Nudging Objects

Nudging lets you move objects by pressing the arrow keys and the PageUp and PageDown keys.

Nudging uses World Space coordinates to reposition objects. Each time you press a key, the object is moved in 1/4 unity size increments (5.12 Bryce units). Refer to “Bryce Units” on page 204 for more on Unity.

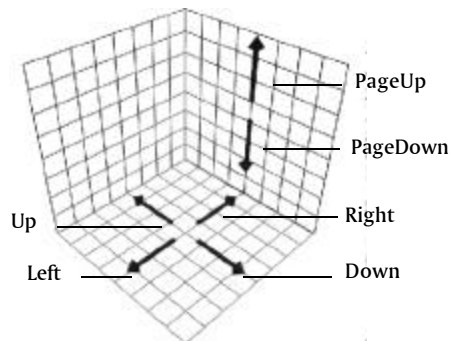

Use the Arrow, PageUp and PageDown keys to nudge objects in World Space.

To nudge an object along the X axis:

- 1 Select one or more objects.
- 2 Press either the Right or Left arrow keys.
 - Hold down Shift to nudge objects in 1/2 unity size increments (10.24 Bryce units)
 - Hold down Option/Alt to nudge objects in 1/256 unity size increments (0.08 Bryce units).

To nudge an object along the Y axis:

- 1 Select one or more objects.
- 2 Press either the PageUp or PageDown keys.
 - Hold down Shift to nudge objects in 1/2 unity size increments (10.24 Bryce units)
 - Hold down Option/Alt to nudge objects in 1/256 unity size increments (0.08 Bryce units).

To nudge an object along the Z axis:

- 1 Select one or more objects.
- 2 Press either the Up or Down keys.
 - Hold down Shift to nudge objects in 1/2 unity size increments (10.24 Bryce units)
 - Hold down Option/Alt to nudge objects in 1/256 unity size increments (0.08 Bryce units).

Aligning Objects

Bryce’s alignment features let you position several object with respect to each other.

Alignment transformations are performed with respect to the Grid. Bryce maintains an internal grid that is comprised of 3D cube increments, 20.48 x 20.48 x 20.48 Bryce units in size.

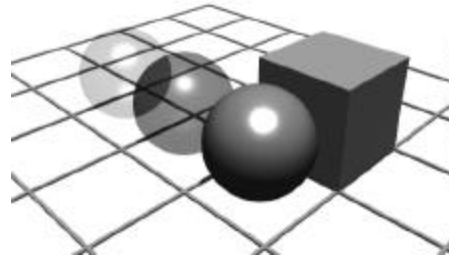

The Grid gives you a common reference for all alignment operations. If all your objects are at unity size you can use grid units to precisely align objects.

The Grid is used for Snap To operations and acts as common reference for alignment operations. One grid unit is equal to unity size, and unity position is always snapped to a position on the grid.

Using the Grid

The Grid can be used as a guide to help you precisely position objects in your scene.

The example provided in the following procedure illustrates how the grid can be used to position a pyramid beside a cube.

To precisely position objects using the grid:

- 1 Make sure all the objects are unity size.
 - When you create primitives like cubes or spheres, they are unity size (20.48 x 20.48 x 20.48 Bryce units).
 - You can return existing objects to unity by holding down Command/Ctrl + Option/Alt and clicking one of its control points.

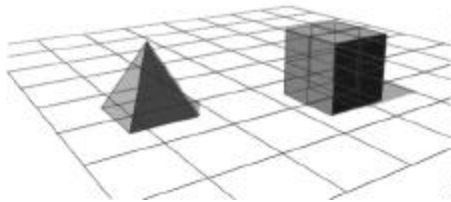

First, return all the objects you're aligning to unity, they fill exactly one grid unit...

This returns the objects to a perfect multiple of Bryce's grid units.

- 2 Determine the objects' positions relative to the grid.
 - When you create an object, it usually appears at World Center or 0, 0, 0.
 - For existing objects, use the Snap to Grid Align option in the Edit palette to move the object to a point on the grid.

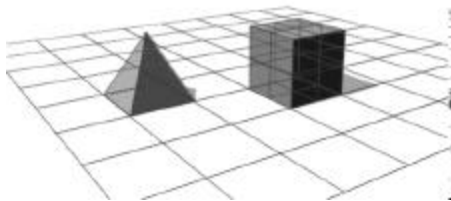

...then align the objects to the grid using the Snap To Grid option...

- 3 Use the nudge controls to move the object. Nudging moves objects in grid increments.

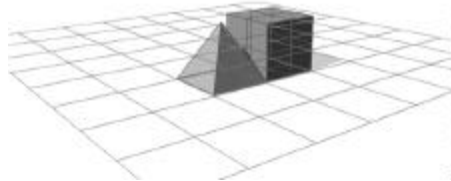

Finally, use the Nudge controls to move in precise increments along the grid.

Using the Align Tool

The Align tool has ten states. As you move the pointer over the tool, the states become active.

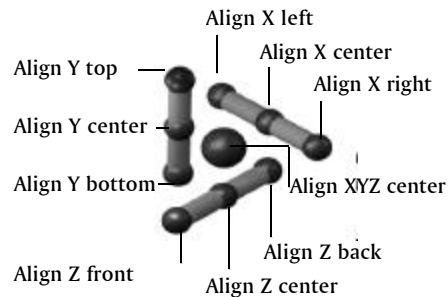

As you move your cursor over the Align tool, a state becomes active.

To align objects along an axis:

- 1 Make sure the Edit palette is visible. If it's not, click the Edit button at the top of the Bryce window.
- 2 Select two or more objects.
- 3 Move the cursor over the Align tool.
- 4 When the state you want to use is active, click the mouse button.

ANCHOR AND NON-ANCHOR BASED ALIGNING

Bryce provides two options for aligning multiple objects: anchor-based aligning and non-anchor-based aligning.

Anchor-based aligning considers the first selected object to be the anchor of the aligning operation. All other objects are aligned to this object.

With non-anchor-based aligning, objects are aligned to the bounding box of all the selected objects.

To choose an aligning option:

- 1 Make sure the Edit palette is visible. If it's not, click the Edit button at the top of the Bryce window.
- 2 Click the triangle icon next to the Align tool, and enable/disable Anchor-Based Aligning.

SNAP TO OPTIONS

The Snap To Options let you automatically align objects to the grid, an anchor object, World Center, or ground level.

To snap objects to the Grid:

- 1 Make sure the Edit palette is visible. If it's not, click the Edit button at the top of the Bryce window.
- 2 Select an object.
- 3 Click the triangle icon next to the Align tool and choose Snap to Grid.

Refer to "Using the Grid" on page 216 for more on the grid.

An anchor object is the object in an alignment operation that does not move.

To snap objects to the center of the anchor object:

- 1 Make sure the Edit palette is visible. If it's not, click the Edit button at the top of the Bryce window.
- 2 Click the triangle icon next to the Align tool, and choose Anchor-Based Aligning.
- 3 Select the objects you want to align.

The first object you select is the anchor object.

- 4 Click the triangle icon next to the Align tool and choose Snap Together.

The X, Y, and Z centers of all selected objects are aligned the X, Y, and Z center of the anchor object.

To snap an object to World Center:

- 1 Make sure the Edit palette is visible. If it's not, click the Edit text button at the top of the Working window.
- 2 Select an object.
- 3 Click the triangle icon next to the Align tool and choose Snap to World Center.

The selected object moves to coordinates X=0, Y=0, Z=0, or World Center.

To drop or lift objects to ground level:

- 1 Make sure the Edit palette is visible. If it's not, click the Edit button at the top of the Bryce window.
- 2 Select an object.
- 3 Click the triangle icon next to the Align tool and choose Snap to Ground.

LANDING OBJECTS

The Snap to Land option lets you snap an object to any object directly below it, much like creating a gravity effect.

When you activate the Snap to Land option, Bryce snaps the selected object to the top of any object directly below its center "Y" control handle.



Using *Snap to Land*, a selected object snaps to the top of any object that's directly below its Y control handle.

The second object must be directly below the Y control handle, otherwise the object lands on the ground plane.

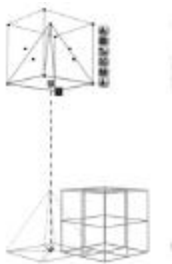

In this example, a corner of the selected object is over the "land" object, but since there are no objects directly under its Y control handle, the selected object lands on the ground.

Landing operations work best with objects that have not been rotated, and that have no sloped characteristics.

This option can create many interesting effects. For example, you can quickly create falling rock animations by placing rock objects throughout your scene with a terrain below them in one frame. Then, in a different frame, select all the rocks and choose the Snap to Land option. When you run the animation, all the rocks will appear to fall onto the terrain. Refer to "Animating" on page 319 for more on animation.

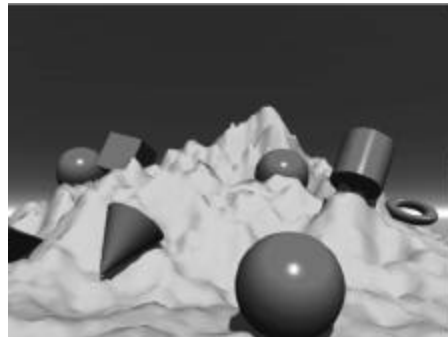
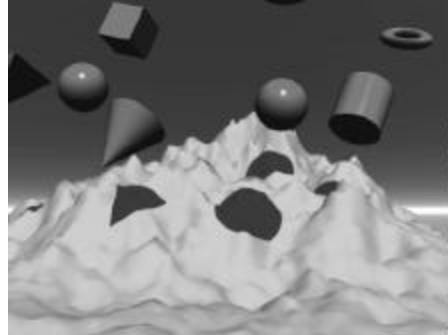

These objects were aligned using the *Land Selection* option.

To SNAP AN OBJECT TO THE TOP SURFACE OF AN OBJECT BELOW IT:

- 1 Make sure the Edit palette is visible. If it's not, click the Edit text button at the top of the Working window.
- 2 Select an object.
- 3 Click the triangle icon next to the Align tool and choose Snap to Land from the menu.
or
Click the Down arrow icon that appears next to the object's bounding box.

ALIGNING NUMERICALLY

The most precise method of aligning objects is by using the 3D Transformations dialog. The dialog uses Bryce units for positioning, so you can use these increments to align objects based on grid increments (20.48=one grid unit).

RANDOMIZING OBJECTS

The Randomize tool is a great way of randomly dispersing objects throughout your scene without having to manually position each object.

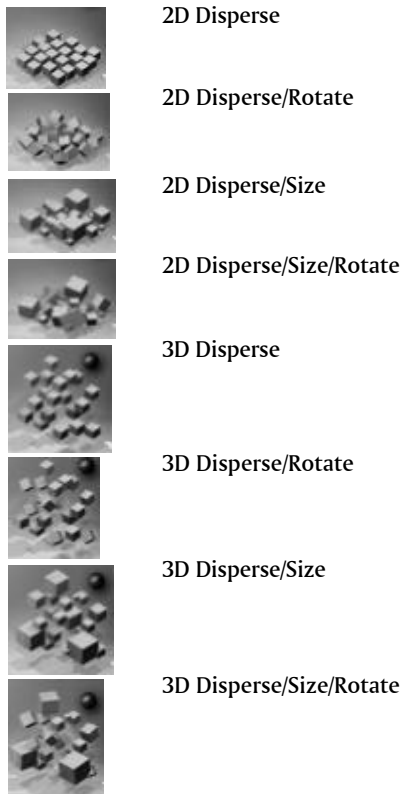

As you click the Randomize tool each of its states becomes active.

USING THE RANDOMIZE TOOL

The Randomize tool has eight states. When you click on the tool, it cycles through its different modes.

TO RANDOMIZE OBJECTS:

- 1 Make sure the Edit palette is visible. If it's not, click the Edit button at the top of the Bryce window.
- 2 Select a number of objects.
- 3 Click the Randomize tool repeatedly until the mode you want to use is active.

or

Click the triangle icon next to the Randomize tool, and choose a mode from the menu.

There are eight modes available:

2D Disperse scatters your selection randomly along the horizontal (X and Z) plane.

2D Disperse/Rotate scatters and rotates your selection randomly along the horizontal (X and Z) plane.

2D Disperse/Size scatters and resizes your selection randomly along the horizontal (X and Z) plane.

2D Disperse/Size/Rotate scatters, resizes and rotates your selection randomly along the horizontal (X and Z) plane.

3D Disperse scatters your selection randomly in 3D space.

3D Disperse/Rotate scatters and rotates your selection randomly in 3D space.

3D Disperse/Size scatters and resizes your selection randomly in 3D space.

3D Disperse/Size/Rotate scatters, resizes and rotates your selection randomly in 3D space.

- 4 Click and drag over the Randomize Amount sphere.

The Randomize Amount sphere is the blue sphere to the top-right of the Randomize tool.

OBJECT HIERARCHIES

An object hierarchy lets you create relationships between objects.

A hierarchy adds structure to the objects in your scene. This can make arranging and animating objects much easier. When you're arranging objects, a hierarchy can make positioning and rotating easier since you can transform an entire hierarchy all at once instead of separately. The same is true for animating. You can quickly create motion animations by changing the position of a parent object, since all its children will move with it.

Hierarchies can be created by either grouping or linking objects.

GROUPING VS. LINKING

Both grouping and linking let you create functional or spatial relationships between objects. The difference is how the objects within each hierarchy work.

Within a group all the objects act as one. When you resize a group of objects, you are resizing all objects in the group simultaneously. This type of hierarchy is good for creating complex objects with static parts, like a tree or a large terrain.

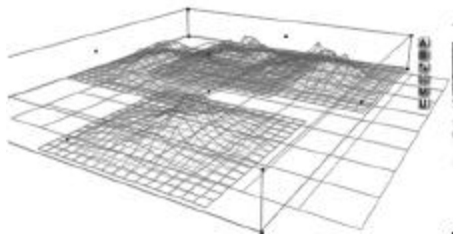

Group hierarchies are good for creating complex objects that have no moving parts like this terrain group. As you move the group all the objects in the group move.

Within a linked hierarchy objects behave differently depending on which object within the hierarchy is being transformed. Any transformation you apply to the parent object is applied to all its children.

However, transformations applied to a child object do not affect the parent. This type of hierarchy is good for creating objects that have moving parts or animating two objects simultaneously.

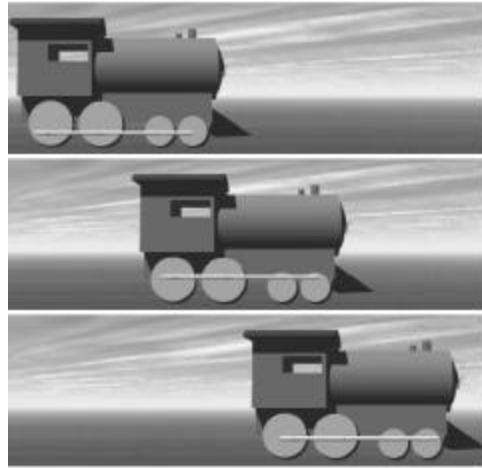

Linked hierarchies are good for creating objects that have moving parts like this train engine. As you move the parent all the objects in the hierarchy move, as the child moves the parent remains unchanged.

You can control exactly which transformations are applied to a child object using the options on the Linking tab in the Object Attributes dialog.

HIERARCHICAL STRUCTURE

A hierarchical structure consists of a parent object or objects and its descendants. In the case of linking, the parent object is at the top of the hierarchy and its children are below it. Children in the hierarchy can also have children creating a branched hierarchy.

In a hierarchy created using links, the parent object is the primary object in the link. The children are any objects linked to the parent. If you have multiple linked objects in a hierarchy, the parent object at the top of the hierarchy is the parent object in the first link you created.

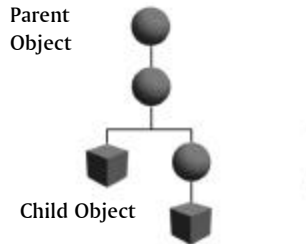

In this link hierarchy, the parent object has one child and that child has two children one of which also has a child. So if you were to transform this hierarchy, any operation you perform on the Parent at the top of the hierarchy is applied to all its children.

In a hierarchy created using groups, the parent object is the group. All the objects within the group are the children. If you have multiple groups within a group, the parent object is the final group you create.

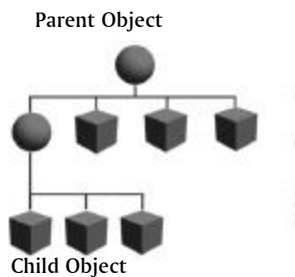

In this group hierarchy the parent group has four children one of which is a group that contains three children. If you were to transform this hierarchy, any operation you perform on the parent group would be applied to all the children.

A hierarchy can be made up of both linked and grouped objects. One way of creating this type of hierarchy is by grouping the parent objects from different link hierarchies together. In this case, the final group you create would become the parent object of the hierarchy.

You cannot create a group using a child object. Only parent objects can be part of a group. When the parent is in a group all its children are also part of the group since they must follow the parent.

You could also create a hierarchy where a group is linked to a parent object. In this case, the parent object of the hierarchy would be the parent from the first link you created.

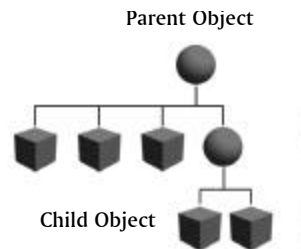

In this hierarchy the parent object is a group that has four children one of which is the parent object of a link hierarchy that has two children.

VIEWING OBJECT HIERARCHIES

The Hierarchy List area of the Advanced Motion Lab lets you see a list of all the objects in your scene. Object hierarchies are indicated by indents. A parent object is listed at the far left of the area; its children appear indented beneath it.

The name of an object that appears in the Hierarchy List can be set using the Object Attributes dialog. If no name is set, a default name is used (for example Sphere 1).

These names are unique for each item in the scene, and are not reused regardless of the number of objects you create or whether the object has been deleted.

TO VIEW A LISTING OF THE HIERARCHY:

- 1 In the Working window, make sure there are no objects selected. This will let you see all the hierarchies in your scene.
- 2 Click the Advanced Motion Lab button at the bottom of the window. The Advanced Motion Lab appears.



The Advanced motion Lab buttons displays the Advanced Motion Lab where you can see the hierarchy listing for your scene.

The Hierarchy List area, located along the bottom-left side of the lab, displays all the hierarchies in your scene.

EXPANDING AND COLLAPSING A HIERARCHY

The arrow buttons next to an object's listing indicate whether the hierarchy is expanded or collapsed. A collapsed hierarchy shows only the parent objects in the hierarchy. An expanded hierarchy shows a listing for all the children.

To expand/collapse a hierarchy listing:

- Click the arrow icon that appears next to a listing's name to expand it.
Click the arrow again to collapse the listing.

LINKING OBJECTS

When you link two objects, you connect them in a *Parent-Child link*.

In a parent-child link, the parent controls the actions of the child. This means that when the parent object moves, so does the child object. However, when the child object moves, the parent object does not.

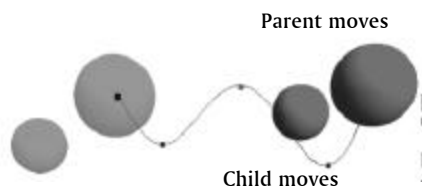

In a parent-child link, the movement of the parent object dictates the movement of the child.

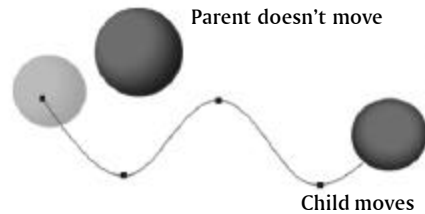

However, the parent object is unaffected by the child object.

A child object will start its movement from its original position and always maintain a constant distance from the parent. The distance is determined by the original positions of the objects before they were linked.

The movement of the child object depends entirely on the type of transformations you apply to the parent object.

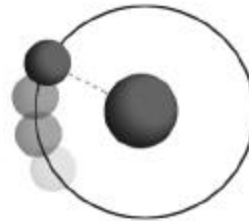

If you rotate the parent, the child will orbit around it like a moon around a planet.

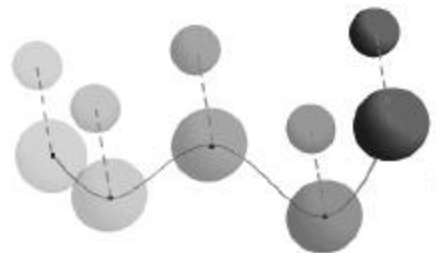

If the parent is moving along a path, the child will match the trajectory of the parent's path, but maintain a constant distance from the parent object.

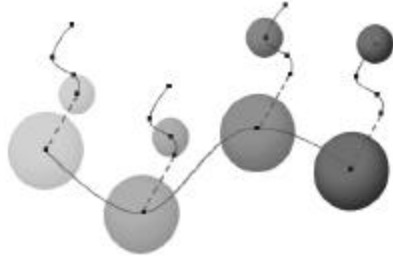

If both the parent and the child are moving along a path, the child object moves along its path while matching the trajectory of the parent object's path.

To link objects in the Working window:

- 1 Select the object you want to set as the child object. A series of icons appear next to the object's bounding box.



The icons along the right side of the object's bounding box let you interactively link objects.

- 2 Click the Link icon and drag the linking line to the object you want to use as the parent object.

You cannot create a link where the parent object is the child of its own child object (i.e. a loop).

The parent object turns blue.

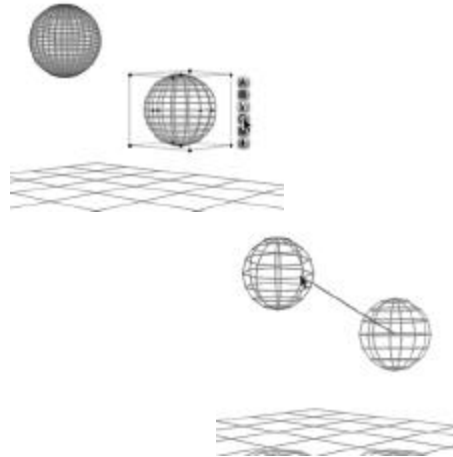

The first object you select becomes the child object. The object you drag the link line to becomes the parent object.

To link objects using the Object Attributes dialog:

- 1 Select the object you want to use as the child object.
- 2 Click the A icon that appears next to the object's bounding box. The Object Attributes dialog appears.
- 3 Click the Linking tab.
- 4 Click the Object Parent Name menu and choose the name of the object you want to use as the parent object.
- 5 Click the OK icon to link the two objects.

To break a link:

- 1 Select a child object.
- 2 Click the A icon that appears next to the object's bounding box. The Object Attributes dialog appears.
- 3 Click the Linking tab.
- 4 Click the Object Parent Name menu and choose None.
- 5 Click the OK icon to unlink the two objects.

Linking Options

Using the options available in the Linking tab on the Object Attributes dialog, you can control which parent object transformations are applied to child objects and how objects are constrained when they're linked to a path.

PARENT TO Child TRANSFORMATIONS Options

Once you've created a link, you can determine exactly which transformations applied to the parent will affect the child.

To set which parent object transformations are applied to a child:

- 1 Display the Object Attributes dialog.
- 2 Click the Linking tab.
- 3 Disable the buttons for the transformation you don't want applied to the child.

GEOMETRIC PATH Linking Options

A Geometric path is an object that acts like a track for controlling the motion of objects. Normally, when you link an object to a Geometric Path, it is constrained to the path. However, using the linking options in the dialog you can disable or enable constraining.

When an object is constrained to the path, it can only move along the path. When it's not constrained it acts like a regular child of the path. Its movement is not constrained to the path.

The options in this dialog also let you set where on the path an object begins its motion.

For more information about geometric paths, refer to "Creating Geometric Paths" on page 88.

To constrain/unconstrain an object to a geometric path:

- 1 Select an object linked to a geometric path.
- 2 Display the Object Attributes dialog.

- 3 Click the Linking tab.
- 4 Enable the Constrain to path button to constrain the object to the path.
 - Disable the button to unconstrain it.

To set where the object sits on the path:

- 1 Select an object linked to a geometric path.
- 2 Display the Object Attributes dialog.
- 3 Click the Linking tab.
- 4 Enter a percentage in the Position field.
 - 100% places the object at the end of the path, and 0% places it at the beginning.

GROUPING Objects

As your scene becomes more complex, you'll need to group objects. Grouping lets you control a set of objects as a single unit. When you perform a transformation on a group, all the objects are equally affected. If you scale a group, all the objects change size, or if you rotate a group, all the objects rotate around a single axis.

Your choice of objects to place in a group depends on how you want to organize your scene. You may want to group the objects that comprise more complex objects, like the walls and turrets of a castle.

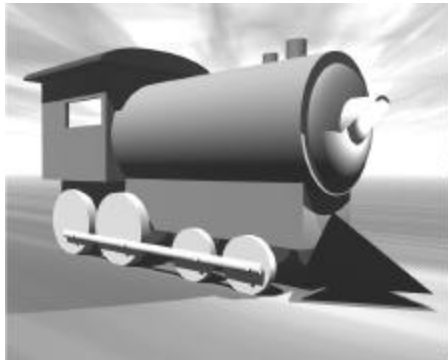
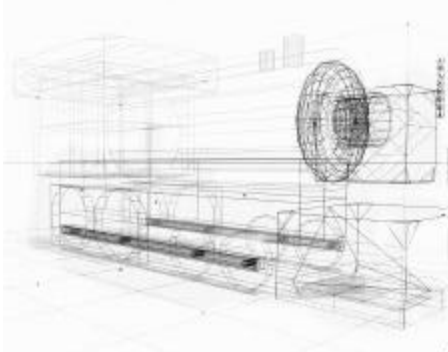

You can group objects to keep all the components of a complex object like this train engine together.

You can also create groups to maintain the spatial relationships between objects as you transform them.

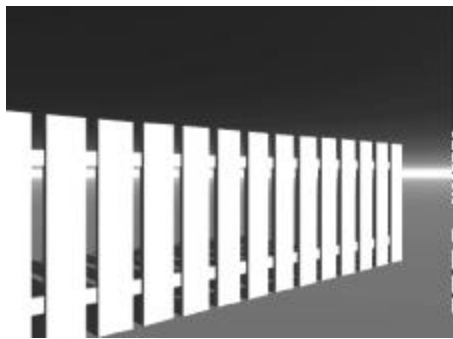

You can also create a group to maintain the spatial relationships between objects as you transform them, like the boards in this fence.

You can place as many objects as you like in your group. You can even nest groups within groups. Nesting can be an easy way of managing more complex scenes.

Groups are essential to creating Boolean objects. Boolean operations will not work unless the objects are part of a group. Refer to “Boolean Operations” on page 73 for more on Boolean objects.

You cannot create a group using a child object. If a child object is part of your selection the “G” icon will not appear.

To CREATE A NEW GROUP:

- 1 Select all the objects you want to group.
- 2 Choose Objects menu > Group Objects, or press Command/Ctrl+G.

You can also click the G button next to the selected objects' bounding box.



Click the G button next to a selection's bounding box to create a group.

To SELECT OBJECTS WITHIN A GROUP:

- 1 Hold down Control/Ctrl and click on an object inside the group bounding box.
- 2 Select the object you want from the menu.

FAMILIES

Families are a way of creating “logical groups.” Unlike regular groups, families are not treated as a single unit with regards to transformations. Families help you keep track of elements in your scene, and can be used for selection purposes. For example, you can put all the elements that make up the background of your scene in to one family, all the items with a particular material in another, all the trees in another and so on.

Each family has a different object color. The color appears only when the object is not selected, since a selected object's bounding box appears red.

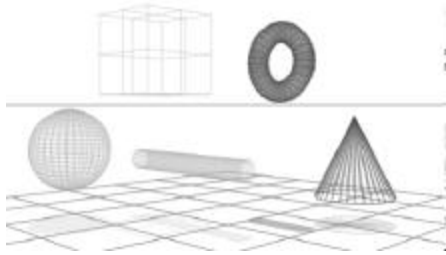

You can easily see which objects belong to the same family when there no objects selected in the Working window.



The Families button in the selection palette displays a list of all the families in your scene.

To CREATE A NEW family:

- 1 Select all the objects you want in the family.
- 2 Click the dark gray box next to the selection's bounding box. The Family dialog appears.



Click the dark gray box next to a selection's bounding box to create a family.

- 3 Click on a color. The color is applied to the wireframes of all the objects in the family.
- 4 You adjust these colors by dragging the rectangular color swatch at the bottom of the dialog. Avoid using black or white since they are difficult to see, or red since it's the color of a selected object.
- 5 Enter a name for the family in the text field.

To SELECT A family:

- 1 If the Animation controls are visible at the bottom of the Bryce window, click the Time/Selection Palette toggle to display the Selection palette.
- 2 Click the Family button and choose the name of the family you want to select from the menu.



10

EDITING OBJECTS

Every object in Bryce has attributes that allow you to control everything from its position in the scene to how it animates along a path. Some objects have special editors specifically designed to adjust the attributes that are unique to the object type.

This chapter describes how to edit object properties and also covers how to use the Torus and Mesh editors.

RESTORING OBJECTS

Every object in Bryce has a default size and shape. When you create an object, the default size is used to define its size and placement.

As you transform and edit objects, these default properties are discarded and replaced. However, you can return an object to its original state at any time.

The Restore control returns the object to its default size and orientation, regardless of the number of transformations you've applied to it.



When you use the Restore control, the cursor changes to a 1 when passed over the object's bounding box.

TO RESTORE AN OBJECT:

- Hold down Control/Ctrl+Alt and click one of the bounding box handles.

EDITING OBJECT ATTRIBUTES

Every object in Bryce has several attributes that let you control the object's size, position, rotation, Boolean state, preview, and whether or not it's locked.

There are two ways of editing an object's attributes: the Object Attributes dialog and the Object Controls that appear next to the object's bounding box.

OBJECT ATTRIBUTES Dialog

The Object Attributes dialog contains three tabs which let you set various object properties:

- General contains options that let you set the object name, position, size, rotation, and display quality.

- Linking contains options that let you set up a link between two objects. You can also use this tab to set up a tracking link.
- Animation contains options for controlling the display of motion paths and setting the motion path type.

TO display THE OBJECT ATTRIBUTES dialog:

- 1 Select an object.
- 2 Choose Objects menu> Edit Attributes, or press Command-Option-E/Ctrl+Alt+E, or click the A button next to the object's bounding box.

OBJECT ATTRIBUTE ICONS

The Object Attribute icons appear as a list of buttons along the right side of an object's bounding box. The icons that appear in this list vary depending on the type and number of objects selected.

These icons let you:

- access the Object Attributes dialog, the Material Composer and any editors associated with the object
- group objects in a selection
- add objects to families
- link objects
- set up object tracking



The Object Attribute icons that appear next to an object's bounding box let you access different editors and set object attributes.

If your selection falls outside of your Working window, the icons appear in the rightmost area available on the screen.

To display Object Attribute icons:

- Select an object or group of objects.

OBJECT ATTRIBUTES ICON



This control displays the Object Attributes dialog. When the dialog opens, it shows the current name, position, orientation, and scale of the object.

To display the Object Attribute dialog:

- 1 Select an object or group of objects.
- 2 Click the A icon that appears next to the object's bounding box.

FAMILIES ICON



This control indicates the family to which the object belongs. It also displays the Family dialog. Refer to "Families" on page226 for more information.

To add selected objects to a family:

- 1 Select all the objects you want to add to the family.
- 2 Click the Family icon that appears next to the object's bounding box. The Family dialog appears.
- 3 Choose a color that represents an existing family, or enter a name to create a new family.
- 4 Click the OK icon. The color you select becomes the object's wireframe color.

Linking Icon



This control lets you set up a parent-child link between two objects. When the objects are linked, the transformations you apply to the parent object affect the child. Refer to "Linking Objects" on page223 for more information.

To link one selected object to another:

- 1 Select the object you want to be the child object within the link.
- 2 Click the Link icon and drag it to the object you want to be the parent object. Release the mouse button when the parent object turns blue.

A link line extending from the child object to the parent appears as you drag.

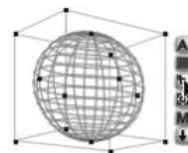

As you drag the Link icon, a link line extends from the child object.

TRACKING ICON



This control lets you set up a Tracking link between two objects. When an object tracks another, the selected object pivots as the target object changes position. As a result, the object always faces its target. Refer to "Tracking Objects" on page344 for more on tracking.

To SET A SELECTED OBJECT TO TRACK ANOTHER:

- 1 Select the object you want to be the stationary object.
- 2 Click the Tracking icon and drag it to the object you want to be the target object. Release the mouse button when the target object turns blue.

A tracking line extending from the stationary object to the target appears as you drag.

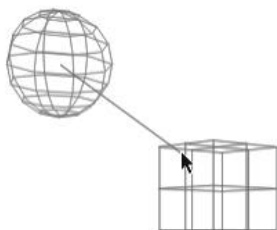
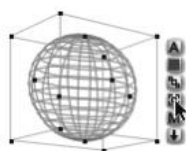

As you drag the Tracking icon, a tracking line extends from the stationary object.

Group Icon



This control appears only if your selection contains multiple objects. When you click this control all the objects in the selection are grouped. Refer to “Grouping Objects” on page225 for more on grouping.

If this icon does not appear when you have a multiple selection, it means that you can’t group the selected objects because of an object hierarchy conflict. Refer to “Object Hierarchies” on page221 for more information.

To GROUP SELECTED OBJECTS:

- 1 Select all the objects you want grouped.

- 2 Click the G icon that appears next to the object’s bounding box. A group bounding box appears around all the objects.

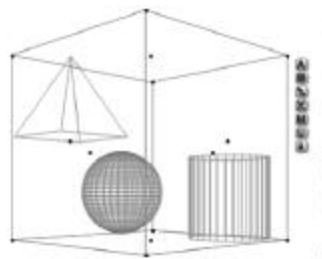

A large bounding box around a number of objects indicates a group.

UNGROUP ICON



This control only appears if you’ve selected a group or a number of objects contained in a group. When you click this control, any group in the selection is ungrouped. If the selection contains nested groups, you can continue clicking this control until all the groups are ungrouped, or until the control disappears.

To UNGROUP A SELECTED GROUP OF OBJECTS:

- 1 Select all the objects you want ungrouped.
- 2 Click the U icon that appears next to the object’s bounding box.

MATERIAL ICON



This control displays the Materials Lab. Refer to “Applying Materials” on page127 for more on Materials. When you use this control, the Materials Lab displays the material currently applied to the selected object, and the object appears in the Material Preview area of the lab.

To display THE MATERIALS LAB:

- 1 Select an object or group of objects.

- 2 Click the M icon that appears next the bounding box.

EDIT OBJECT ICON



This control only appears if the object you selected is a terrain, a symmetrical lattice, a torus, a stone, an imported polyhedron object or a light. When you click this control, the editor for the object type you have selected opens.

TO DISPLAY AN OBJECT'S EDITOR:

- 1 Select an object or group of objects.
- 2 Click the E icon that appears next to the bounding box.

LAND OBJECT ICON



This control appears as either an arrow pointing up or down, depending on the position of the object selected.

When you click this control, the object snaps to the top of the object below it. This control works like the Land Selection option available in the Edit palette. Refer to "Landing Objects" on page 218 for more information.

TO LAND A SELECTED OBJECT:

- 1 Select the object you want to land.
- 2 Click the Arrow icon that appears next to the object's bounding box. The object snaps to the top of the object directly below it.

If the selected object is below ground, it snaps to the bottom of the object directly above it.

EDITING OBJECT NAMES

The Object Name field in the General tab of the Object Attributes dialog lets you name a selected object. An object's name identifies it within the scene.

When you have many objects of the same type, object names are used to select a specific object. The name is also used to identify an object in a hierarchy. Object hierarchies appear in the Hierarchy List area of the Advanced Motion Lab. Refer to "Object Hierarchies" on page 221 for more on hierarchies.

EDITING BOOLEAN ATTRIBUTES

Boolean attributes, listed in the General tab of the Object Attributes dialog, control how an object acts in a Boolean operation. For example, if a boolean attribute is set to Negative, the object subtracts an area from a positive object.



These are examples of some of the objects you can create using Boolean operations.

Refer to "Boolean Operations" on page 73 for a complete discussion of Boolean operations.

TO SET AN OBJECT'S BOOLEAN ATTRIBUTES:

- 1 Display the Object Attributes dialog.
- 2 Make sure the General tab is displayed.
- 3 Enable one of the check boxes at the top of the dialog:

Neutral defines any selected object, objects, or group as non-Boolean. No Boolean operation can be performed on a neutral object. This is the default setting for all objects.

Positive defines any selected object, objects, or group as solid when grouped.

Negative defines any selected object, objects, or group as negative when grouped. Think of a negative object as a “cutting object.”

Intersect defines any selected object, objects, or group as an intersecting object when grouped.

Editing Display Quality Attributes

The display options available in the General tab of the Object Attributes dialog let you control how the object appears in the Working window. Some of these options can speed up the redraw of your scene.

Hidden

When you apply this option to an object, it is not rendered when you render your scene. The object remains visible in the Working window, where you can still select and edit it, but it will not display in the final render.

To hide an object:

- 1 Display the Object Attributes dialog.
- 2 Make sure the General tab is displayed.
- 3 Enable the Hidden button.

Locked

This option locks any selected object, objects, or group, preventing unintentional changes to size, position, rotation, or material assignment. Locked objects appear grayed out in your wireframe view.

To lock an object:

- 1 Display the Object Attributes dialog.
- 2 Make sure the General tab is displayed.
- 3 Enable the Locked button.

To select a locked object:

- 1 Click the Time Selection Palette toggle at the bottom of the Working window to display the Selection palette.



Use the Time Selection Palette toggle to switch between the Animation controls and the Selection palette.

- 2 Click an object type button, and choose the desired object from the menu that appears.

If you want to unlock the object, disable the Locked button in the Object Attributes dialog.

Show as Box

This option displays any selected object, objects, or group as a box. This is useful when you just want to work with the object's position. It can speed up work in a complex scene because it displays simpler objects. You can still manipulate your object using the bounding box control points.

To display an object as a box:

- 1 Display the Object Attributes dialog.
- 2 Make sure the General tab is displayed.
- 3 Enable the Show as Box button.

Show Origin Point

This option displays the selected object's origin point. You can then edit the position of the point to change the object's center of rotation. Refer to “Object Origin Points” on page 207 for more on origin points.

To display an object's origin point:

- 1 Display the Object Attributes dialog.
- 2 Make sure the General tab is displayed.
- 3 Enable the Show Origin Point button.

Editing Transformation Attributes

The numeric entry fields on the General tab of the Object Attributes dialog describe an object's position, orientation, and size in 3D space. You can adjust these attributes by entering values in one or all of the numeric fields.

The values in this dialog use either Absolute or Definition coordinates for transformations. Absolute coordinates use the World Space X, Y, and Z axes as a reference for transformations. Definition coordinates redefine how the object is created in Object Space. Refer to "Coordinate Systems" on page 204 for more on these coordinate systems.

Using Definition coordinates can create some unpredictable results because you're redefining the entire object when you change the Offset, Rotate and Size values.

To set an object's origin point:

- 1 Display the Object Attributes dialog.
- 2 Make sure the General tab is displayed.
- 3 Enter values in the Origin X, Y and Z fields.

To set an object's position:

- 1 Display the Object Attributes dialog.
- 2 Make sure the General tab is displayed.
- 3 Enter a value in the Position X field to set the object's position on the X axis. This axis moves the object left or right.
- 4 Enter a value in the Position Y field to set the object's position on the Y axis. This axis moves the object up or down.
- 5 Enter a value in the Position Z field to set the object's position on the Z axis. This axis moves the object backward or forward.

When you select multiple objects and access this dialog, there are no values displayed in the Position fields. If you then enter a value in any

field, the selected objects are moved to the new coordinate.

To rotate an object:

- 1 Display the Object Attributes dialog.
- 2 Make sure the General tab is displayed.
- 3 Enter a value in the Rotate X field to set the object's rotation around the X axis.

You can enter negative values, values greater than 360 or values less than -360. Bryce reduces the value to an absolute value within a range of 0 - 360.

- 4 Enter a value in the Rotate Y field to set the object's position on the Y axis.
- 5 Enter a value in the Rotate Z field to set the object's position on the Z axis.

To set an object's size:

- 1 Display the Object Attributes dialog.
- 2 Make sure the General tab is displayed.
- 3 Enter a value in the Size X field to set the object's size in the X axis.

You can enter negative values here if you need to.

- 4 Enter a value in the Size Y field to set the object's size in the Y axis.
- 5 Enter a value in the Size Z field to set the object's size in the Z axis.

When you select multiple objects and access this dialog, there are no values displayed in the Size fields. If you then enter a value in any Size field, the selected objects are scaled to the new coordinate.

Editing Link Attributes

Link attributes control how an object is linked to another. The controls on the Linking tab of the Object Attributes dialog let you set parent-child link attributes and tracking attributes.

Linking

When you link an object to another, you create a parent-child relationship. Transformations applied to the parent object affect the child, but transformations applied to the child object do not affect the parent. Refer to “Linking Objects” on page223 for more on linking.

The Link options let you set the parent object for the selected object and choose which parent object transformations will affect the child.

To link objects:

- 1 Display the Object Attributes dialog.
- 2 Click the Linking tab.
- 3 Click the Object Parent Name field and choose a name from the menu that appears.
Choose None to break a link.
- 4 Enable a Propagate option. These options control which Parent object transformations affect the child.

Tracking

When you set up a tracking link, the stationary object tracks the target object as it moves or rotates. Whenever the target object moves, the stationary object pivots so that it's always facing the target.

The Tracking options let you set the target object for the selected object and define which axis of the stationary object will face the target.

To set an object to track another:

- 1 Display the Object Attributes dialog.
- 2 Click the Linking tab.
- 3 Click the Track Object Name field and choose a name from the menu that appears.
Choose None to break a tracking link.
- 4 Enable one of the Orientation options. These options set which object axis will track the target.

Editing Animation Attributes

Animation attributes control the display of an object's motion path. A motion path is a graphical representation of an object's trajectory over the course of the animation. Refer to “Motion Paths” on page330 for more on motion paths.

The options on the Animation tab of the Object Attributes dialog let you control how an object's motion path is displayed in the Working window and how that path is drawn.

Motion Path Display Options

Normally, a motion path is displayed as it is being drawn and when the object is selected. The motion path display options on the Animation tab of the Object Attributes dialog let you control when the motion path is displayed.

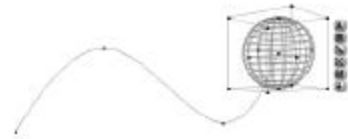

The Motion Path Display options let you control when an object's motion path appears.

To set motion path display options:

- 1 Display the Object Attributes dialog.
- 2 Click the Animation tab.
- 3 Enable one or all of the display options:
 - Hide Trajectory enables or disables the display of the motion path. When it is disabled, no motion path is drawn.
 - Show When Selected displays the motion path only when the object is selected.
 - Show Always displays the motion path at all times, even when the object is not selected.

MOTION PATH ATTRIBUTES

When a motion path is created, it looks like a curve that extends out from an object. The motion path attributes let you display additional information on a motion path.

To SET MOTION PATH ATTRIBUTES:

- 1 Display the Object Attributes dialog.
- 2 Click the Animation tab.
- 3 Enable one or all of the attributes:
 - Show Handles displays or hides the path's control handles. The handles represent key frames.
 - Show Tangents hides or displays lines extending from each control handle. Tangents help you see the slope of the curve.
 - Show as Ribbon displays the motion path as a flat ribbon in the working window. This makes the path easier to see when you move the camera.

ALIGN OPTIONS

Normally, unless you apply a rotation, an object's orientation remains constant as it moves along a motion path. The align options let you force the object's orientation to match the slope of the motion path so that as the path curves up, the object tilts up.

To SET ALIGN OPTIONS:

- 1 Display the Object Attributes dialog.
- 2 Click the Animation tab.
- 3 Enable one of the following options:
 - Do Not Align disables aligning. The shape of the curve has no effect on the object's orientation. This is the default setting.
 - Align adjusts the object so that its orientation matches the shape of the path.

MOTION PATH GEOMETRY OPTIONS

The shape of a motion path is determined by the position of the object as it moves through the animation. The motion path geometry options let you change the shape of the path to create different effects.

To SET MOTION PATH GEOMETRY OPTIONS:

- 1 Display the Object Attributes dialog.
- 2 Click the Animation tab.
- 3 Enable one or all of the options:
 - Make One Shot performs the motion once and does not repeat the motion.
 - Make Repeat creates a loop in the action. The motion on the path will continuously repeat.
 - Make Pendulum creates a repeating cycle in the action along a path. The object will move forward on the path and then back.
 - Make Circular closes the path to create a circular path. The object will move along the path until it reaches the end. It then swings around to the front of the path and starts over. You must have at least four position key frame points for this feature to work.

EDITING TORUSES

A torus object is any pre-made donut-shaped object in Bryce. The Torus editor lets you adjust the inner radius of any torus object. The preview is automatically updated as you change the inner radius. You can zoom in and out of the preview window, and you can preview the torus object from different angles by rotating the preview image.

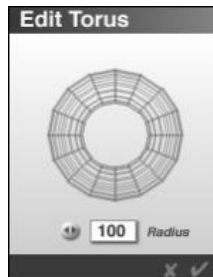

Use the Torus editor to adjust the inner radius of a torus object.

To display the Torus editor:

- 1 Click a Torus object.
- 2 Click the Ebutton that appears next to the object's bounding box.

To adjust the inner radius of a torus:

- 1 In the Torus editor, drag on the Torus in the preview window. Release the mouse when the radius is the size you want.

You can also specify the inner radius by typing a value in the Radius field.

- 2 Click the check mark.

To zoom in and out:

- In the Torus editor, hold down Control/Ctrl + Option/Alt and drag on the Torus in the Preview window.

To preview a torus from different angles:

- In the Torus editor, hold down Control/Ctrl and drag on the Torus in the preview window.
or
Press Caps Lock to toggle the continuous spin mode.

EDITING IMPORTED MESHES AND STONES

Imported objects (such as DXF or 3DMF objects) and native Stone objects are both treated as meshes inside Bryce.

The Mesh Editor lets you adjust the smoothness of an object's surface. You can smooth objects that are very rough or remove the smoothing previously applied to DXF objects.

It is not a good idea to smooth or unsmooth stones. These objects are highly dependent upon the clumpiness of the polyhedral shape as well as the bumpiness in the assigned procedural texture to retain their realism. Smooth stones look very unnatural.

To smooth imported objects or stones:

- 1 Click the imported object or stone.
- 2 Click the Ebutton that appears next to the object's bounding box.
- 3 Adjust the value of the smoothing range by dragging the gauge along the left side of the dialog.

The gauge sets the maximum angle you wish to be smoothed.

For instance, you may wish to smooth all angles under 90° to preserve the sharpness of cubes. In that case, set the maximum angle to 85 before smoothing.

- 4 Click the Smooth button until you achieve the desired effect. The more you click, the smoother the object becomes.

To unsmooth imported objects or stones:

- 1 Click the imported object or stone.
- 2 Click the Ebutton that appears next to the object's bounding box.
- 3 Adjust the value of the smoothing range by dragging the gauge along the left side of the dialog.

The gauge sets the maximum angle you wish to be unsmoothed.

For instance, you may wish to unsmooth all angles under 90°. In that case, set the maximum angle to 85 before unsmoothing.

- 4 Click the Unsmooth button until you achieve the desired effect. The more you click, the sharper the object becomes.

To export a mesh object:

- 1 Select the mesh object you want to export.
- 2 Click the E button next to the object's bounding box.
The Edit Mesh dialog appears.
- 3 Click Command/Ctrl+D.
The Save dialog appears.
- 4 Choose a location and filename for the mesh object.

CONVERTING OBJECTS

The Convert tool in the Edit palette lets you convert any type of object into another type of object with a single click. You can change a square into a light, a terrain into a sphere, or an infinite plane into a cone.

Any transformations you applied to the original object are preserved through the conversion.

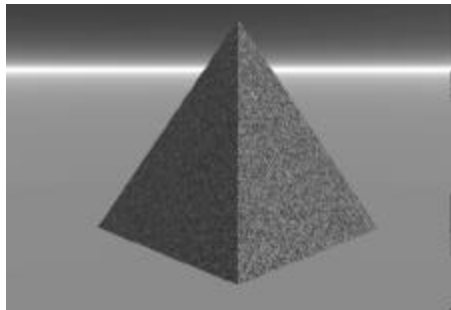

The Convert tool lets you quickly turn an object into any other. In this example, the object changed from an Egyptian pyramid...

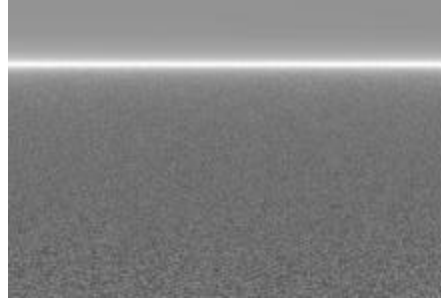

...to a rocky desert by converting the pyramid primitive into a plane.

Conversions cannot be animated. You can't have a box that turns into a cone over time.

To convert an object to another type of object:

- 1 Select the object you want to convert.
- 2 Click the Edit button at the top of the Bryce window to display the Edit palette.
- 3 Click the double-headed arrow in the top-left corner of the palette and choose an object type from the palette that appears.

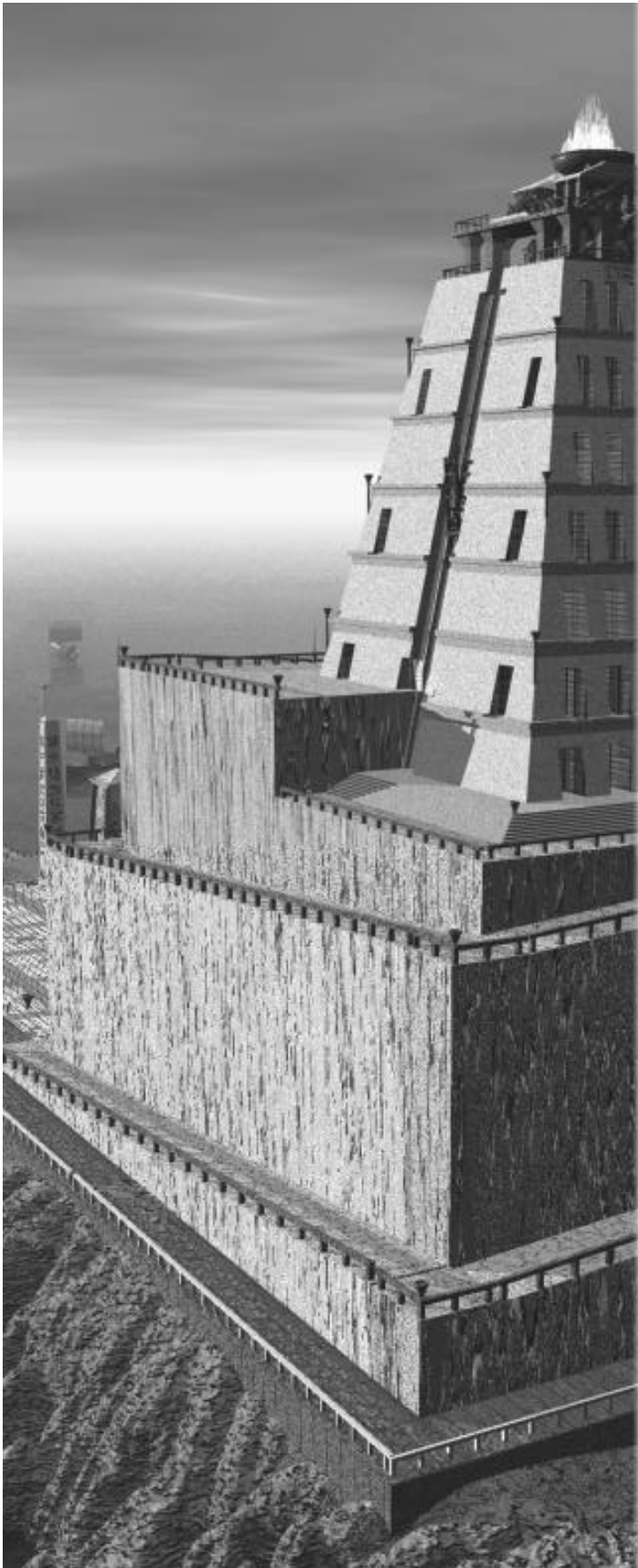

11

CREATING SKIES

A Bryce sky defines the virtual environment of your scene. Unlike many other 3D applications, the Bryce virtual environment is not merely a backdrop; it is an infinite 3D representation of natural environmental phenomena.

All of the elements in your sky interact with each other just as they would in the real world. Colors in your environment interact with everything in your scene just as they would in nature. For example, red sunlight is invisible until it strikes an object; then the object exhibits red highlights. If it's a blue object, it takes on a purple cast and so on.

The colors in the sky change depending on the position of the sun, and how much moisture (Haze, Fog) is present in the atmosphere. All this, plus natural reflection, refraction, and more make the Bryce Sky&Fog palette responsible for a great deal of the natural, or supernatural, look and feel of Bryce images.

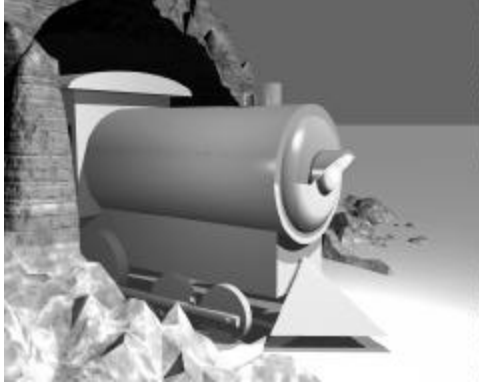

The objects in your scene may look incredibly realistic on their own ...

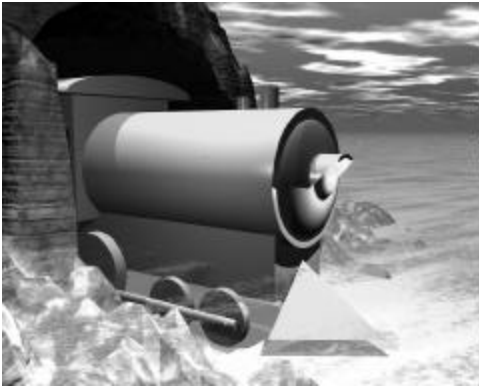

...but when you add a sky, the scene becomes a window looking out into a real world.

You can add even more realism to a sky by enabling one of the many environmental effects available for skies. Using these effects you can create night skies full of stars, or have a bright rainbow streaking across the roof of your world. One of the most spectacular effects is the Volumetric World effect. When this effect is enabled all the light in your scene appears as visible rays. This is similar to the effects of light shining through clouds on a hazy day.

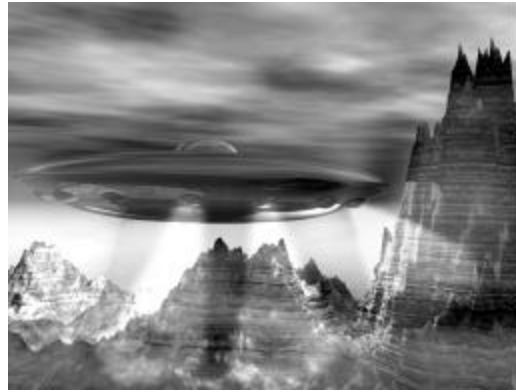

The other-worldly look of this spaceship landing was created using Volumetric World.

Like any other scene setting, skies can be animated. Any property of a sky can be changed at different points along the animation timeline. When the animation plays, the sky property will appear to change over time. Using this technique, you can create a scene that changes from day to night, or from clear to cloudy. Refer to “Animating Skies” on page 354 for more on animating skies.

THE SKY & FOG PALETTE

The Sky&Fog palette is where you’ll set up the attributes of your environment. The palette uses visual controls in the form of thumbnails to help you see how changing the value of an attribute affects your sky.

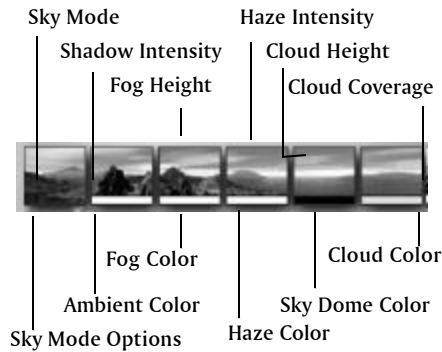

The Sky&Fog palette's thumbnails let you set values for sky attributes.

The name of the control you're adjusting appears in the Text Display area of the Control palette. You can also use this area to help guide you if you prefer numeric precision, as when you are adjusting the setting of a control; this area displays the current control's value.

Each control has at least one color swatch along the bottom of the thumbnail. These swatches are used to set the color for a given sky attribute, like cloud color or fog color.

Next to the thumbnails are a series of controls that let you set the frequency and amplitude of clouds, set the position of the sun or moon, and store sky properties. You can see their effects in the Preview area.

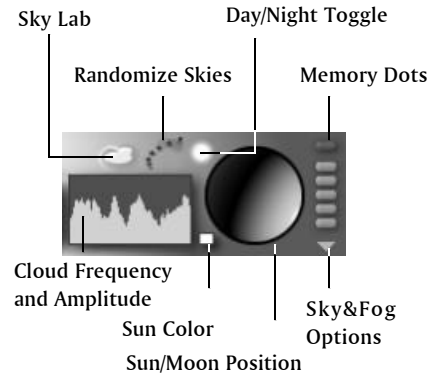

The set of controls at the end of the palette does not have visual guides, but you can see their effects in the Preview area.

WORKING WITH Sky Lab

The Sky Lab button provides access to the Sky Lab dialog. This dialog contains controls for fine-tuning environmental effects like clouds, rainbows, and sun and moon rings. Click the Sky Lab button, which looks like a cloud with a rainbow, in the Sky&Fog palette to display the Sky Lab dialog. You can also click the triangle icon below the memory dots and choose Sky Lab from the menu.

The dialog contains three tabs:

- Sun&Moon contains controls for positioning the sun and moon as well as adding effects like rings and horizon illusions.
- Cloud Cover contains controls for editing cloud textures and setting up cloud animations.
- Atmosphere contains controls for rainbows, visible lights, and color blending.

You can preview your changes in the Sky Lab dialog.

- To view the different preview options, click the downward pointing triangle at the lower corner of the preview area. You can also change the camera position in the preview area.

- To change the position of the camera, drag the preview. To orbit around the scene, drag the preview in the direction you want to move the view of your scene.

WORKING WITH THE SKY & FOG PALETTE

The Sky&Fog palette has several settings that you can use to control how the palette affects your scene and how the sun tracks your camera view. You can also use the palette's memory dots to store settings as you experiment with different environmental attributes.

USING THE CONTROL THUMBNAILS

The thumbnails are visual guides, and they are also used to set the attributes of Sky&Fog effects.

TO CHANGE THE INTENSITY OF AN EFFECT:

- Drag to the left or right inside the thumbnail to change the intensity of the effect.

TO PICK A COLOR FOR AN EFFECT:

- Click the color bar below the thumbnail. A color picker appears and your pointer changes to an eyedropper.

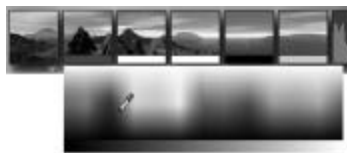

Click on the bar below the thumbnail to access the color picker.

While the eyedropper is active, you can select colors from anywhere in your scene, or even different parts of the interface.

For more control after picking with the color picker, try Option-click/Alt-click to get the second color editor, switch to HLS mode and adjust saturation or lightness (less saturated colors can make for more realistic fog and haze effects), or you can enter numeric values if you need to precisely match specific colors.

SETTING PALETTE OPTIONS

The Sky&Fog palette options let you link the palette controls directly to your scene. To link Sky&Fog attributes directly to your scene:

- Click the triangle icon below the memory dots at the right edge of the palette and choose Auto Update from the menu.
- When this option is enabled, every change you make to the Sky&Fog palette settings will start a render of your scene with the new sky settings.

Unless you have marquee'd a small region to be updated, every change you make will begin a completely new render.

TO RESET SKY&FOG PALETTE SETTINGS TO THEIR DEFAULTS:

- Click the triangle icon below the memory dots at the right edge of the palette and choose Reset Sky from the menu.

SAVING SKY & FOG SETTINGS

The memory dots in the Sky&Fog palette let you store your favorite Sky&Fog settings. Using these dots you can safely explore many Sky&Fog configurations without losing your favorite settings along the way. Memory dots appear along the right side of the palette.



Use the Memory dots to store your favorite Sky&Fog settings.

TO SAVE SKY&FOG SETTINGS:

- In the Sky&Fog palette, click on an empty dot (empty dots are gray).

All the current Sky&Fog palette settings are stored in the selected dot.

To switch to a saved Sky & Fog setting:

- Click on a full dot (full dots are blue). The current settings are replaced with the settings stored in the dot.
An active dot will be blue with a white point inside it.

To reset Sky&Fog settings to default:

- In the Sky&Fog palette, click the uppermost memory dot. This dot always appears full.

To delete a saved Sky&Fog setting:

- Option/Alt-click on a full MemoryDot.
The uppermost dot cannot be cleared.

Memory dots are saved with the scene, but not between sessions, so you may want to save your favorite skies as presets before ending a Bryce session.

Randomizing Skies

Randomizing skies is a very powerful way of exploring possibilities you may never find any other way. When you randomize the sky all the settings in the palettes are replaced by randomly generated values.



Click the Randomize Sky button to randomly generate sky settings.

To randomize your sky:

- Click on the Randomize Sky Button.
Remember, you can always return to the default settings by clicking on the top Memory Dot.

Working with Sky Modes

The Sky modes act as the base of your sky. The Sky modes control lets you set the base colors and light tones for your environment. There are four modes available: Soft Sky, Dark Sky, Custom Sky, and Atmosphere Off.

As you switch between the modes, the thumbnail also changes to give you a preview of what the mode looks like.

To select a sky mode:

- Click the Sky mode thumbnail to cycle through the four modes, or
- Drag left or right inside the thumbnail to cycle through the modes, or
- Click the triangle icon next to the thumbnail and choose a mode from the menu.

Sky Modes

Soft Sky is the default state of the sky. It features softer shades of blue and lighter tones.



Darker Sky is a darker version of Soft Sky. It uses darker shades of color and tones. This mode is good for creating more brooding skies.



Custom Sky lets you choose your own colors for the sky; this way you can create some truly alien environments. When this mode is selected, the standard behavior of colors in the sky with respect to sun position is disabled.

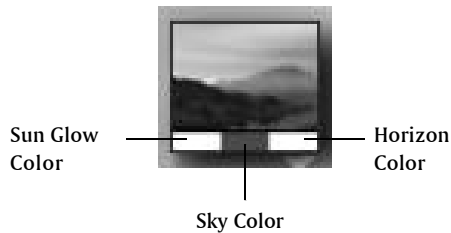

In Custom Sky mode you can pick your own colors for the sky.

Atmosphere Off disables the standard sky color behaviors, relative to sun position, and uses a single color for the sky. This mode is useful when you need to render objects against a simple colored (or black or white) background. The Sun color still affects objects in this mode. If you have red sunlight, for instance, objects in your scene will reflect red light.



To SET CUSTOM sky colors:

- 1 Click the triangle icon next to the Sky Mode thumbnail and choose Custom Sky from the menu. The thumbnail changes to the Custom Sky control.
- 2 Click the Sky Color swatch and choose a color from the color picker.
The Sky Color is the main sky color in this mode, regardless of sun position.
- 3 Click the Sun Glow Color swatch and choose a color from the color picker.
This is the color of the halo around the sun.
- 4 Click the Horizon Color swatch and choose a color from the color picker.

This color will in certain cases affect your scene below ground level if you have a haze setting of greater than zero. It will also impact the color of Stratus clouds near the horizon.

In most cases, this will be the least obviously used color in your scene; unless you are making outer space scenes, in which case this could be very useful for you.

To RENDER OBJECTS AGAINST A plain background:

- 1 Click the triangle icon next to the Sky Mode thumbnail and choose Atmosphere Off from the menu. The thumbnail changes to the Atmosphere Off control.
- 2 Click the Atmosphere swatch and choose a color from the color picker.
- 3 Drag left inside the Haze control and set the value to 0. This setting eliminates the suggestion of a horizon.

SETTING Sky ATTRIBUTES

Once you've selected a Sky mode, you have the basis for your virtual environment. All the other atmosphere effects you add later will interact with the base mode. There are two other attributes that affect how all the other effects will appear: Shadows and Ambient color.

SHADOWS IN YOUR SCENE

All the objects in your scene cast shadows. Using the Shadow control you can set the intensity and color of all the shadows in your scene.



Use the Shadows control to set the color and intensity of shadows in your scene.

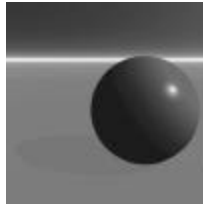

Shadows=10

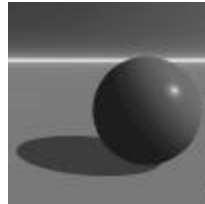

Shadows=90

As you change the value of the Shadow control, the brightness of shadows changes.

The shadow control is not the only control for shadows. The position of shadows is dependent on the position of the sun. Since the sky interacts directly with objects in the scene, the color of the sun also affects the color of shadows.

The object's material properties also affect the color of shadows. Semi-transparent or transparent objects with a transparency color will change the color of the object's shadow. As well, volume materials can dramatically change the shape and color of shadows.



Use the Shadows control to set the color and intensity of shadows in your scene.

By default, the Clouds in Bryce do not cast shadows. If you want the cloud layer to cast shadows on the ground below, enable the Cloud Shadows option. Refer to "Cloud Cover" on page 256 for more on this option.

To SET shadow intensity:

- 1 Display the Sky&Fog palette by clicking the Sky&Fog button at the top of the Bryce window.
- 2 Drag left or right inside the Shadow control thumbnail. Dragging left decreases the intensity and dragging right increases it.



The cursor changes to a two headed arrow as you drag over the control.

To SET shadow intensity NUMERICALLY:

- 1 If it's not already visible, display the Sky&Fog palette by clicking the text item on the menu bar.
- 2 Click the Sky Lab button. The Sky Lab dialog appears.



Use the Sky Lab dialog to set sky attributes numerically.

- 3 Click the Sun & Moon tab to display the Sun & Moon palette.
- 4 Click the Sun/Moon Shadows field, then enter a value, or drag the slider. This field governs the intensity of shadows rendered in your image. The range is 0 to 100, and the default value is 90.

AMBIENT COLOR

The Ambient Color is the color of all the light that surrounds the objects in your scene. Light from the sun interacts with ambient color to produce the color for both highlights and shadows.

Ambient Color is used as the source color for material Ambience. The Ambient Color tints the surfaces of all objects in your scene that have some level of ambience. Any other color you apply to the object's surface is mixed with the Ambient color to create the final surface color. For example, if the Ambient Color is red, any color you assign to an object's surface ambience is mixed with red.

Refer to "Ambience" on page 135 for more on material ambience.

TO SET AMBIENT COLOR:

- Click the color swatch below the shadow control thumbnail and choose a color from the color picker.

For realistic effects, at noon, or in the afternoon, ambient color should be a little blue to get nice blue-ish shadows. At dawn, you can set Ambient Color to red or pink, and at night you can set it to gray-blue.

You can also set the ambient color by using the Ambient color swatch in the Sky Lab.

Adding FOG AND HAZE

Fog and Haze are two atmospheric effects that can add realistic depth to your scene. Fog can make objects appear to disappear the farther they get from the camera. Haze can add the illusion of a

distant horizon. The Fog and Haze controls in the Sky&Fog palette let you control the color and intensity of these effects.

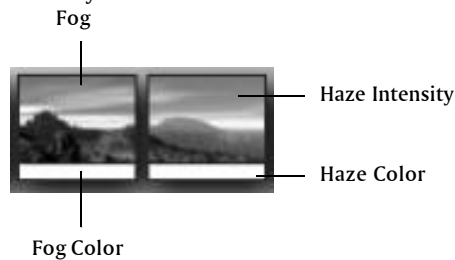

Use the Fog and Haze controls to set the intensity and color of Fog and Haze effects.

Fog

Fog can add an element of sensuality, mystery, and even realism to your scenes. It acts like a thin layer of cloud close to the ground. Using Fog you can create the illusion of depth without having to add distant objects.



Fog can create a sense of depth in your scene. In this scene, the fog was used to add depth to the road as it moves away from the camera. Notice how the feeling of depth was created without the addition of background objects.

You can set intensity, height, and color attributes for the fog.



Fog=10



Fog=90

For example, you can see how the fog changes in these skies as the Fog value changes.

The fog acts as a global layer covering the entire scene. Its color and intensity are the same throughout the scene.

To SET THE AMOUNT OF Fog:

- 1 Display the Sky&Fog palette by clicking the Sky&Fog text button.
- 2 Drag horizontally inside the Fog thumbnail to increase or decrease the amount of fog in your rendered scene. Drag to the left to decrease the amount of fog, and to the right to increase it.

To SET Fog height:

- 1 Display the Sky&Fog palette by clicking the Sky&Fog text button.
- 2 Drag vertically inside the Fog control to increase or decrease the height of your fog. Drag up to increase the height and down to decrease it.

The height and amount values are displayed in the Text area of the Control palette as you drag.

To SET Fog color:

- 1 Display the Sky&Fog palette by clicking the Sky&Fog text button.
- 2 Click the color swatch beneath the Fog thumbnail and choose a color from the color picker.

To SET Fog ATTRIBUTES NUMERICALLY:

- 1 If it's not already visible, display the Sky&Fog palette by clicking the text item on the menu bar.
- 2 Click the Sky Lab button. The Sky Lab dialog appears.
- 3 Click the Atmosphere tab.
- 4 Click the Fog Density and/or Thickness fields, then enter a value. These fields set the amount of fog rendered in your image. The range is 0 to 100%, and the default value is 0%.
- 5 Click the Base Height field, then enter a value. This field sets the height of fog rendered in your scene, assuming there is a value greater than zero in the Fog field. The range is 0 to 100%, and the default value is 0%. It translates the entire atmospheric effect up or down without changing the density or thickness. Base Height provides control over density at low altitudes, such as in valleys. In earlier versions of Bryce, you had to move the entire scene up or down relative to the atmosphere.

BLENDING THE Fog COLOR

Since the fog remains constant throughout the scene, you may get some odd looking results when you're creating a sunset or sunrise. In these cases the sun is very close to the ground plane where the fog exists, so the fog should react to the sunlight. The Blend with Sun feature lets you create exactly this effect. As the sun approaches the Fog, the color and intensity of the fog changes to interact with the color of the sun.

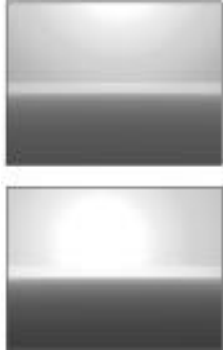

In this example, the Fog is linked to the sun so you can see the changes in the fog color and intensity as the sun gets closer to the horizon.

To link Fog color to the Sun controls:

- 1 If it's not already visible, display the Sky&Fog palette by clicking the text item on the menu bar.
- 2 Click the Sky Lab button. The Sky Lab dialog appears.
- 3 Click the Atmosphere tab.
- 4 Click the Blend with Sun button.
- 5 Make sure the Blend Fog button is enabled.
- 6 Enter a value in the Color field, or drag the slider, to set how much of the fog color is blended with the sun.
- 7 Enter a value in the Luminance field, or drag the slider, to set the intensity of the fog color when it's blended.

To get the best effect, set both these fields to 100.

Localized Fog

There may be times when you want to create localized pockets of fog. For this type of effect you'll need to use an object with a volume material applied to it; this way the object looks like fog. The area covered by the fog is then controlled by the size of the object. A flattened sphere usually makes a good fog volume.

This technique can also be used to create visible smoke, or gas.

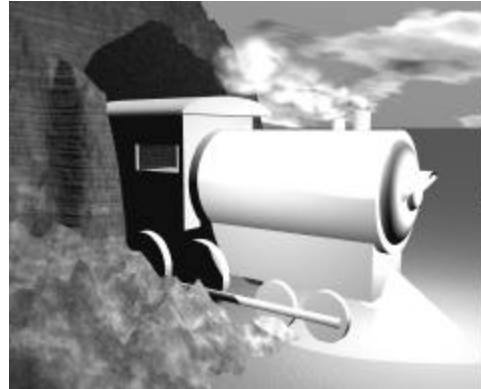

In this example, the effect of puffy smoke was created by applying a volume material to a flattened sphere object.

To create localized fog:

- 1 Display the Create palette.
- 2 Click the Sphere tool. A sphere object appears in the scene.
- 3 Squash and stretch the sphere, until it is the desired shape. Refer to "Transforming Objects" on page 206 for more on transforming objects.
- 4 With the object selected, click the M icon that appears next to its bounding box. The Materials Lab appears.
- 5 Click the Volume button at the top of the lab.
- 6 Set up the values for channels in the material. Refer to "Building Materials" on page 162 for more on creating materials.
 - Choose a cloud-like texture from texture components. Stratus, Cumulus or one of the CloudBump textures work well.
 - Pay special attention to the Base Density channel as this sets the transparency of your fog.
 - You need to set a high value for the Edge Softness channel to blur the edges of the sphere object.

- 7 Click the OK icon to exit the lab.
- 8 In the Working window, move the object to the area where you want the fog to appear.

HAZE

Haze is the natural effect you see when a plane (like the ocean) stretches out towards the horizon. At this distant point a different color appears over the horizon and light becomes fuzzy.



Haze creates the illusion of a distant horizon. In this scene, the haze is used to create the distinction between the water plane and the sky.

The Haze control lets you set the intensity and color of the Haze effect in your Bryce scene.

With haze set to zero, your horizon will have an unnaturally hard edge. Also note that the Cloud Altitude control will affect the height of this band of haze. The higher the altitude of the atmosphere, the wider the band of haze at the horizon.

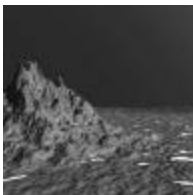

Haze=0



Haze=90

You can see how the haze changes in these skies as the Haze value changes.

Haze is applied to the entire scene equally. The haze always appears at the horizon.

To SET HAZE INTENSITY:

- 1 Display the Sky&Fog palette by clicking the Sky&Fog button at the top of the Bryce window.
- 2 Drag horizontally inside the Haze thumbnail to increase or decrease the degree of haze in your scene. Drag to the left to decrease the amount of haze and to the right to increase it.

To SET HAZE INTENSITY NUMERICALLY:

- 1 If it's not already visible, display the Sky&Fog palette by clicking the button at the top of the Bryce window.
- 2 Click the Sky Lab button. The Sky Lab dialog appears.
- 3 Click the Atmosphere tab.
- 4 Enable the Haze option.
- 5 In the Haze area, enter values in the Haze Density, Thickness, and Base Height fields. These fields govern the amount of haze rendered into your scene. The range is 0 to 100, and the default value is 4.

Density controls density of the lower part of the atmosphere, and affects the scattering of light around the sun.

Thickness scales the whole atmosphere up or down, with the density at "sea level" remaining unchanged.

Base Height provides control over density at low altitudes, such as in valleys. It translates the entire atmospheric effect up or down without changing the density or thickness. In earlier versions of Bryce, you had to move the entire scene up or down relative to the atmosphere.

To SET HAZE COLOR:

- 1 Display the Sky&Fog palette by clicking the Sky&Fog button at the top of the Bryce window.

- 2 Click the color swatch beneath the Haze thumbnail and choose a color from the color picker.

Fog and Haze colors should be the same, or almost the same. For realism, the haze should be a little brighter and bluer than the fog. At nighttime, you have less illumination, so an effective nocturnal haze color could be dark blue-gray.

BLENDING THE HAZE COLOR WITH THE SUN

Since the Haze always appears at the horizon it should change color as the sun sets or rises. The Blend with Sun feature lets you simulate this effect. When the two elements are linked, the haze color and brightness change depending on the position of the sun. This creates very realistic looking sunsets.

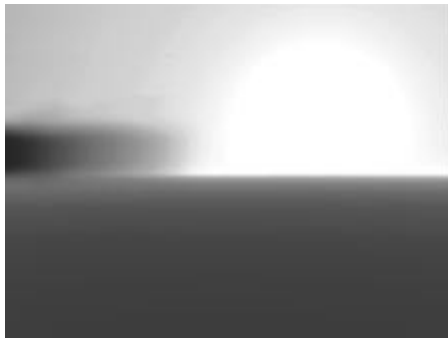

In this example, the haze is linked to the sun. You can see how the color of the horizon changes as it gets closer to the sun.

When you're using this feature to create sunsets, you should choose the haze color carefully so as to create a natural-looking color scheme.

To link HAZE TO THE SUN CONTROLS:

- 1 If it's not already visible, display the Sky&Fog palette by clicking the text item on the menu bar.
- 2 Click the Sky Lab button. The Sky Lab dialog appears.
- 3 Click the Atmosphere tab.
- 4 Click the Blend with Sun button.

- 5 Make sure the Blend Haze and Blend Fog buttons are enabled.
- 6 Enter a value in the Color field, or use the slider, to set how much of the haze color is blended with the sun.
- 7 Enter a value in the Luminance field, or use the slider, to set the intensity of the haze color when it's blended.
- 8 To get the best effect, set both these fields to 100.

SETTING THE COLOR PERSPECTIVE

Color perspective is the change in color with distance that characterizes the appearance of distant scenes in Nature: Dark areas turn blue and light ones yellow to orange to red. In Bryce you can make things change any color you like with distance. Color perspective is half of aerial perspective, while the other half is the loss of contrast with distance.

Color perspective controls the rate at which the red, green and blue components of the atmosphere come in with distance. In Nature, the atmosphere is white or a pale shade of gray. The blue component of that shade comes in faster than the green, which in turn comes in faster than the red. This is because the Earth's atmosphere scatters blue light more efficiently than green, and red least efficiently of all. The net result is that as a dark area recedes into the distance, it will turn blue before it turns white or pale gray in the far distance. Similarly, white areas will turn yellow, then orange, then red with increasing distance. The default values of color perspective are very delicate: if you change them, expect unpredictable results!

To SET THE COLOR PERSPECTIVE:

- 1 If it's not already visible, display the Sky&Fog palette by clicking the text item on the menu bar.
- 2 Click the Sky Lab button. The Sky Lab dialog appears.

- 3 Click the Atmosphere tab.
- 4 Click the Color Perspective button.
- 5 Click the RGB controls to control the rate at which the red, green, and blue components of the atmosphere come in with distance.

Clouds in Bryce

There are two kinds of clouds in Bryce: clouds in the environment and cloud planes.

Clouds you add to your sky interact with the light in your scene. They can block out the light of the sun and change the color of the light that hits the objects in the scene. These clouds are infinitely distant so you cannot fly through the clouds in the sky. If you want to have this effect, use a cloud plane. Sky clouds can also cast shadows on the ground below.



The clouds in this scene were created using Cumulus clouds from the Sky and Fog palette.

You can change the look of the clouds by editing the texture used to create them. By changing the texture you can alter the shape and position of the clouds within the sky.

Cloud planes are infinite planes that act as objects in your scene. They cast shadows and can interact with other objects.



An infinite cloud plane was used to create the mist above the water in this scene.

Both types of clouds can be animated. The clouds in the sky can be animated by changing their color, position or frequency, and cloud planes can be animated just like other objects. They can also be animated using the Cloud Motion controls. These controls let you set parameters for automatically animating clouds. Refer to “Animating Skies” on page 354 for more on animating clouds.

Adding Clouds

The Sky&Fog palette provides several controls that set the attributes of clouds in your sky. The Cloud Coverage, Cloud Altitude, and Cloud Frequency and Amplitude controls let you set the general appearance of your clouds. The Cloud Color sets the color of the clouds.

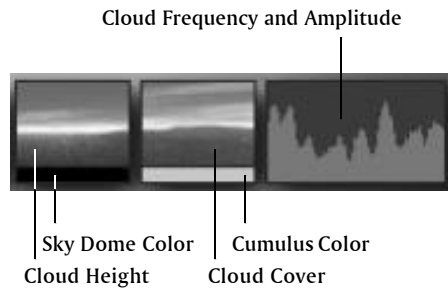

Use the cloud controls to set the attributes of the clouds in your scene.

You can add clouds to your scene in five easy steps:

- Select the type of cloud
- Adjust the cloud texture
- Set the cloud coverage and color
- Set cloud height
- Set the frequency and amplitude of clouds

Cloud Types

There are two types of clouds you can add to your Bryce environment: Cumulus and Stratus. Cumulus clouds are generally found at lower altitudes and appear thicker and fluffier.

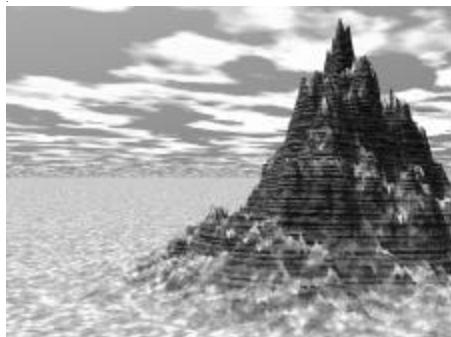

The sky in this scene uses Cumulus clouds.

The Stratus appear at higher altitudes and appear thinner and more wispy.

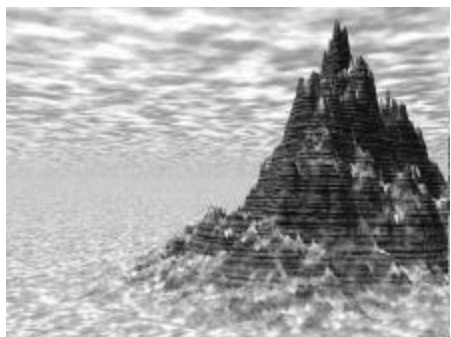

The sky in this scene uses Stratus clouds.

To add Cumulus clouds to a sky:

- 1 If it's not already visible, display the Sky&Fog palette by clicking the Sky&Fog button at the top of the Bryce window.
- 2 Click the triangle in the corner of the palette and choose Cumulus Clouds.

Cumulus clouds are thicker, darker clouds at a lower altitude. These clouds will take on tints of Sunlight color, Ambient color, or Cumulus color.

To add STRATUS clouds to a sky:

- 1 If it's not already visible, display the Sky&Fog palette by clicking the Sky&Fog button at the top of the Bryce window.
- 2 Click the triangle in the corner of the palette and choose Stratus Clouds.

Stratus clouds are bright white, thin, clean clouds that appear at high altitudes. These clouds are very responsive to Sunlight color and Sky Dome color, and less responsive to Cumulus color or Ambient color.

You can also choose both cloud types, or neither. Selecting neither cloud type creates a clear sky.

Editing Cloud TEXTURES

Clouds in Bryce are created using a procedural texture with a cloud pattern. The color, position, size, and pattern within the texture determines the final look of the cloud in your sky. You can edit this texture using either the Sky Lab palette, or for more complex editing, you can use the Texture Editor.

The texture used for a cloud can come from either the Bryce texture library or you can create your own.

To edit cloud TEXTURE in the Sky Lab dialog:

- 1 If it's not already visible, display the Sky&Fog palette by clicking the Sky&Fog button at the top of the Bryce window.

- 2 Click the Sky Lab button. The Sky Lab palette appears.
- 3 Click the Cloud Cover tab.



The Cloud Cover tab provides controls that let you edit the textures that are used to create the clouds in your scene. As you change a texture, the texture preview updates.

- 4 Click the grey + or - Turbulence buttons to increase or decrease the amount of noise in the texture.
 - Increasing the Turbulence creates a more dense pattern within the texture.
- 5 Click the blue + or - Complexity buttons to increase or decrease the amount of detail in the texture.
 - Increasing the Complexity increases the complexity of the patterns within the texture.
- 6 Click the Reset button to restore the original settings, if you want to start over.
- 7 Click the OK icon to apply your changes.

To edit cloud textures in the Deep Texture Editor:

- 1 If it's not already visible, display the Sky&Fog palette by clicking the Sky&Fog button at the top of the Bryce window.
- 2 Click the Sky Lab button. The Sky Lab palette appears.

- 3 Click the Cloud Cover tab.
- 4 Click the Edit button below the type of clouds you want to edit.
- 5 Click the Edit button. The Deep Texture Editor appears.

The cloud texture and its components appear in the component windows.

If you're not familiar with using the Deep Texture Editor you may get some very unpredictable results which may result in clouds that don't look much like clouds. Before you start editing the clouds texture you may want to refer to "Creating and Editing Textures" on page 169 for more instruction on how to use the editor.

- 6 If you want to add additional turbulence to the cloud texture, adjust the texture's Noise:
 - Click the Noise button at the bottom of the editor. The Noise control appears. The Noise control lets you adjust the frequency of the noise in any of the texture's components.
 - At the top of the Noise control, click the button associated with the component you want to edit.
 - Adjust the Noise slider to increase/ decrease the frequency of the noise in the texture.
- 7 If you want to change the colors of a component, click one of the color indicators in the component window and choose a new color.
- 8 If you want to add more complexity to the texture, adjust its Phase:
 - Click the Phase button at the bottom of the editor. The Phase control appears. The Phase control lets you adjust the amplitude of the phase in any of the texture's components.

- At the top of the Phase control, click the button associated with the component you want to edit.
 - Adjust the Phase slider to increase/decrease the amplitude of the phase.
- 9 If you want to change the pattern in the texture, apply a filter:
- Click the Filter button at the bottom of the editor. The Filtering control appears. The Filtering control displays a graphical representation of the filter applied to your texture. By changing the equation of the filter to the value of the variables, you can change the patterns within the cloud texture.
 - At the top of the Filtering control, click the button associated with the component you want to edit.
 - Change the filter equation and variable values to adjust the filter applied to your texture.

Filtering is a rather complex operation. Try experimenting with different equations and see what happens.

- 10 Click the OK icon to exit the editor.

Cloud COVER

Cloud Cover controls the quantity of clouds you can see in the sky. A high coverage means that there is a very dense cloud layer, and a low setting means that there are very few clouds in the sky.

Cloud cover also indirectly controls the brightness of the environment. The more cloud coverage you have in a sky, the darker the environment, since less sunlight can pass through the clouds.

Adjusting cloud coverage changes the quantity of clouds but not the frequency. You can think of it as adjusting the volume on a radio without changing the station.

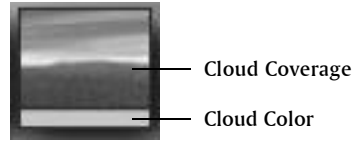

The Cloud Coverage control in the Sky & Fog palette lets you interactively set the quantity of clouds in the sky.



Cloud Coverage=10



Cloud Coverage=90

For example, you can see how the clouds change in these skies as the cloud coverage value changes.

To SET cloud COVERAGE:

- 1 If it's not already visible, display the Sky&Fog palette by clicking the Sky&Fog button at the top of the Bryce window.
- 2 Drag left or right inside the Cloud Coverage control thumbnail. Drag left to decrease coverage and right to increase it.

To SET cloud COVERAGE NUMERICALLY:

- 1 If it's not already visible, display the Sky&Fog palette by clicking the Sky&Fog button at the top of the Bryce window.
- 2 Click the Sky Lab button. The Sky Lab dialog appears.
- 3 Click the Cloud Cover tab.
- 4 Drag the slider or enter a value in the Cloud Cover field.

To SET cloud COLOR:

- 1 Display the Sky&Fog palette by clicking the Sky&Fog button.
- 2 Click the color swatch beneath the Cloud Coverage thumbnail and choose a color from the color picker.

Cloud Height

The height of your clouds has an impact on the appearance of your sky. Greater heights will result in smaller, more distant cloud formations, as well as a thicker band of haze at the horizon. Lower heights result in larger, more languorous cloud formations and a thinner band of haze at the horizon.

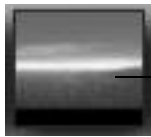

Cloud Height

The Cloud Height controls in the Sky & Fog palette let you interactively set the height of the cloud layer in the sky.



Cloud Height=10



Cloud Height=90

For example, you can see how the clouds change in these skies as the cloud altitude value changes.

There are two things to remember when working with this control. First, the Cloud Height will affect the size of your Haze band, if you have a haze setting greater than zero. The higher the altitude, the wider the haze region will be on the horizon. Second, remember to lower your altitude setting if you are creating a nighttime scene. Since high altitudes increase the size of the horizon Haze region, the sky will be too unnaturally bright for realistic night scenes.

To set cloud height:

- 1 If it's not already visible, display the Sky&Fog palette by clicking Sky & Fog on the menu bar.
- 2 Drag horizontally inside the Cloud Height control thumbnail. Drag left to decrease altitude and right to increase it.

To set cloud height numerically:

- 1 Display the Sky&Fog palette by clicking the Sky&Fog text button.
- 2 Click the Sky Lab button. The Sky Lab dialog appears.
- 3 Click the Cloud Cover tab.
- 4 Drag the slider or enter a value in the Cloud Height field.

FREQUENCY AND AMPLITUDE

The Frequency and Amplitude control lets you set the types of cloud formation you'll see in your sky. By combining these two controls you can change your clouds from light and fluffy to dark and brooding.



Use Frequency and Amplitude to control the types of cloud formations in your scene.

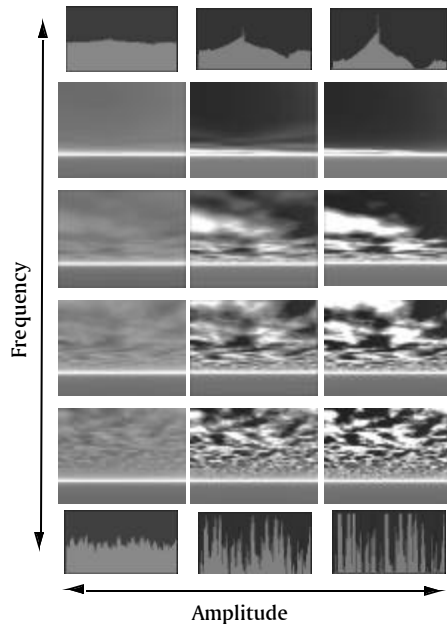

This graph shows the effects of different Frequency and Amplitude settings on a sky. Frequency values range from 2 at the top to 150 at the bottom. The Amplitude values range from 50 at the left to 500 on the right.

To SET Cloud FREQUENCY AND Amplitude:

- 1 Display the Sky&Fog palette by clicking the Sky&Fog button at the top of the Bryce window.
- 2 In the Cloud Frequency and Amplitude control, drag horizontally to control the frequency of your cloud formations.

Drag right, and the “spikes” will get closer together, resulting in smaller formations. Drag left for larger, more luxurious formations.

The Text Display area shows you the numerical value of the amplitude as you drag.

- 3 Drag vertically to control the amplitude of your cloud formations.
Drag away from the horizontal center, and the spikes increase in height, resulting in

formations with harder edges. Drag toward the horizontal center for softer-edged formations.

Note: It is possible to invert the spikes. This means that you can exchange positive and negative spaces in your sky. If you invert the amplitude, everything that was previously clear sky will be clouds, while everything that was cloud will be clear sky.

To SET FREQUENCY AND Amplitude NUMERICALLY:

- 1 If it's not already visible, display the Sky&Fog palette by clicking the text item on the menu bar.
- 2 Click the Sky Lab button. The Sky Lab dialog appears.
- 3 Click the Cloud Cover tab.
- 4 Drag the slider or enter a value in the Frequency field. The Frequency field controls the frequency (scale) of cloud formations in your scene.
- 5 Drag the slider or enter a value in the Amplitude field. The Amplitude field controls the amplitude (edge softness) of clouds in your scene.

Sky DOME Color

Sky Dome Color lets you create a color wash over your scenes, even if there is no sunlight present. This color simulates the natural effect that occurs when you have color in the sky even though the sun has set. Sky Dome Color lets you create late afternoon or evening scenes.

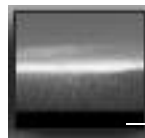

Sky Dome Color

The Sky Dome Color control in the Sky & Fog palette lets you choose a color from either the color picker or the color dialog.

For late afternoon and early evening realism, try using a touch of orange or yellow. This will create a

cast of color over your entire scene, regardless of the position or color of the sun or moon.

To SET Sky DOME color:

- 1 If it's not already visible, display the Sky&Fog palette by clicking the text item on the menu bar.
- 2 Click the color bar beneath the Cloud Height control thumbnail and choose a color from the color picker.

Linking Clouds TO THE CAMERA VIEW

If you move the camera view during an animation, the clouds in your environment will appear to zoom by, creating a kind of time-lapsed effect. If you want the clouds to appear fixed as you move the camera, link the cloud in the sky to the camera view. This way, wherever the camera moves the clouds will follow, so that they seem to remain stationary.

To link clouds to view:

- 1 If it's not already visible, display the Sky&Fog palette by clicking the text item on the menu bar.
- 2 Click the Sky Lab button. The Sky Lab dialog appears.
- 3 Click the Cloud Cover tab.
- 4 Click the Link Clouds to View button.
Refer to "Animating Skies" on page 354 for more on animating skies.

Using A FIXED Cloud PLANE

As you move higher up in a Bryce environment, the cloud pattern shifts, so that it appears as if you're getting closer to the clouds. If you want to counter this effect, you can use the Fix Cloud Plane option to freeze the cloud pattern so that it doesn't change as you move higher up.

To USE A FIXED cloud PATTERN IN YOUR sky:

- 1 If it's not already visible, display the Sky&Fog palette by clicking the text item on the menu bar.
- 2 Click the Sky Lab button. The Sky Lab dialog appears.
- 3 Click the Cloud Cover tab.
- 4 Click the Fixed Cloud Plane button.

SETTING THE Cloud MOTION

You can set the speed and turbulence of clouds as well as specify the direction of motion.

To SET cloud speed:

- 1 If it's not already visible, display the Sky&Fog palette by clicking the text item on the menu bar.
- 2 Click the Sky Lab button. The Sky Lab dialog appears.
- 3 Click the Cloud Cover tab.
- 4 Drag the slider, or enter a number in the Speed field.

To SET cloud TURBULENCE:

- 1 If it's not already visible, display the Sky&Fog palette by clicking the text item on the menu bar.
- 2 Click the Sky Lab button. The Sky Lab dialog appears.
- 3 Click the Cloud Cover tab.
- 4 Drag the slider or enter a value in the Turbulence field.

To SET THE DIRECTION OF MOTION:

- 1 If it's not already visible, display the Sky&Fog palette by clicking the text item on the menu bar.
- 2 Click the Sky Lab button. The Sky Lab dialog appears.

- 3 Click the Cloud Cover tab.
- 4 Drag the Cloud motion control to specify the angle of motion.

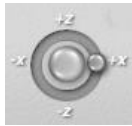

WORKING WITH THE SUN

The sun is the source of all natural light in your scene. Its attributes have a profound effect on the look of your scene.

The color of the sun affects all the colors of all the objects in the scene; Sunlight color tints all the other visible colors.

The position of the sun controls the time of day in your scene. If the sun is above the horizon, it is day; if it is below, it is night, and if it is at the horizon, it is sunrise or sunset.

The sun can be animated just like all the other elements of your Bryce scene. You can create time-elapsd effects by changing the position of the sun over the course of an animation. Refer to “Animating Sun or Moon Position” on page356 for more on animating the Sun.

POSITIONING THE SUN

The sun position control sets the direction your natural light is coming from whether it is sunlight or moonlight. The position can be set using the Sun control in the Sky & Fog palette. The control works like a trackball, with the sun at one end and the moon at the other.

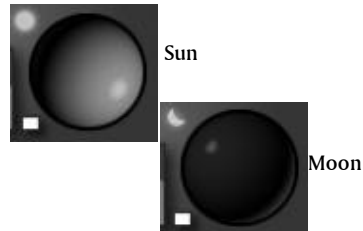

The control works like a trackball. As you drag over the control, both elements move in the direction you drag.

You can think of the control as a compass: if the highlight on the Sun Control sphere is positioned at 12 o'clock, the light comes from the north, and so on.

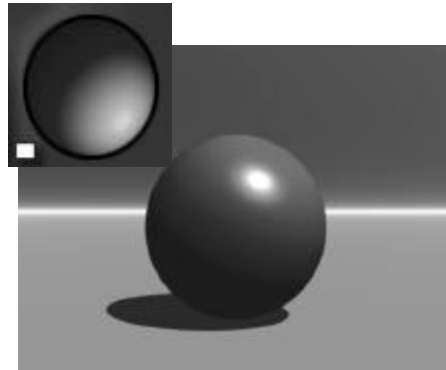

As you change the position of the sun, the “time of day” changes. When the sun position is closer to the edges of the control, the sun appears closer to the horizon, making the scene darker.

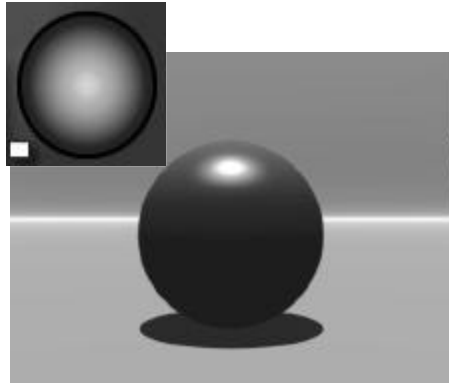

When the sun is in the center of the control, the sun shines from directly above the sun, like it would at high noon.

The colors in your sky will change depending on the position of the Sun Control, or the “time of day...” just like in the real world.

The angle of the shadows changes as the sun changes. If your object is shiny, and there are no other light sources, the position of the sun controls where the highlight appears.

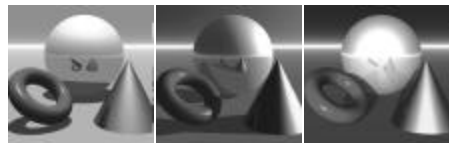

In this example, you can see the effects of the sun’s position on several reflective and shiny objects.

DAY AND NIGHT

Your sky normally contains two bodies: the sun and the moon. There is always one body visible in your sky. At night it is the moon and in the day it is the sun.

The two bodies are connected and always remain at opposite ends of the sky. As you move the sun you’re also moving the moon. This means that when the sun dips below the horizon in front of you, the moon is rising behind you.



The link between the sun and the moon can be seen by positioning the sun at the horizon in front of the camera.

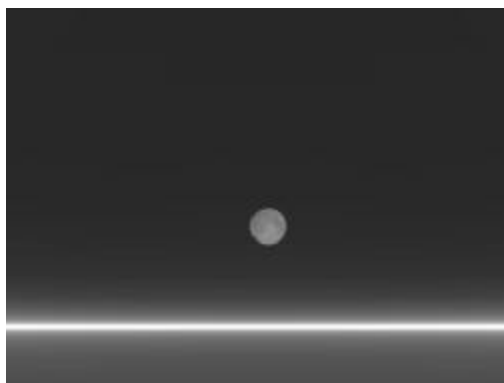

If you turn the camera 180°, you’ll see the moon just rising over the horizon as well.

TO SWITCH BETWEEN NIGHT AND DAY:

- 1 Display the Sky&Fog palette.
- 2 Click the Day/Night toggle button in the top-left corner of the sun position controls.

SUNRISE/SUNSET

You can create a sunset or sunrise by positioning the sun so that it is visible on your horizon.

You can position the sun manually by using the Sun/Moon control, or numerically by specifying values in the Sky Lab. You can also position the sun exactly where you want it to appear in your scene.



Sunsets or sunrises can be created by moving the sun closer to the horizon.

The colors in the sky automatically change to create the illusion of the sunrise or sunset colors. You can also use the Sky Dome color to give your sunset/sunrise added color.

For a more realistic sunset you may want to link the fog and haze to the sun so that they react to the sun color as it approaches the horizon. Refer to “Blending the Fog Color” on page249 and “Blending the Haze color with the Sun” on page252 for more on this feature.

You may also want to enable the Horizon illusion for the sun. This feature makes the sun appear larger as it approaches the horizon. Refer to “Sun/Moon Horizon Illusion” on page267 for more on this effect.

To position the sun manually:

- 1 Display the Sky&Fog palette by clicking the Sky&Fog button at the top of the Bryce window.
- 2 Drag the larger highlight area in the Sun Position controls to the position where you want the light to originate.

You can position the sun, or the moon, on the horizon as you like by nudging the Sun Control until the light is visible in your scene.

To position the sun numerically:

- 1 Display the Sky&Fog palette by clicking the Sky&Fog button at the top of the Bryce window.
- 2 Click the Sky Lab button. The Sky Lab palette appears
- 3 Click the Sun & Moon tab.
- 4 In the Sun Controls area, type a value into the Azimuth field. The Azimuth field controls the east-to-west position of the sun. The range is 0 to +360.
- 5 Enter a value in to the Altitude field. The Y field controls the height of the sun relative to your scene. The range is -90 to +90.

Positive values are above the horizon, negative values below.

To position the sun with precision:

- 1 Display the Sky&Fog palette by clicking the Sky&Fog button at the top of the Bryce window.
- 2 Hold down Control+Option/Ctrl+Alt, and double-click the Sun control.
- 3 Hold down Control+Option/Ctrl+Alt, and in the working window, click where you want to position the sun.

Linking the Sun to the Camera

Normally, you’d have to reposition the sun every time you changed the camera to maintain a certain effect or sunlight angle. However, if you apply the Link Sun to Camera, your sun will track the camera. The position of the sun relative to the camera remains the same no matter where the camera is positioned. This way you can set up the sun position once and then not worry about losing the effect as you move the camera.

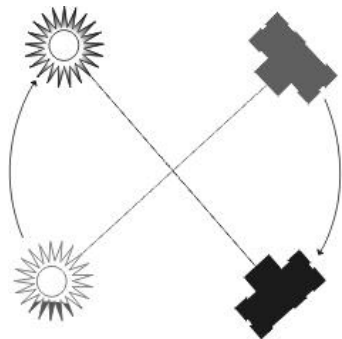

When the sun is linked to the camera, the sun moves relative to the Camera. Wherever the camera moves the sun follows. As it moves, the sun maintains a constant distance from the camera.

This feature can also be very useful when you're animating your scene. Refer to "Animating" on page 319 for more.

To link the sun to the camera:

- 1 Display the Sky&Fog palette by clicking the Sky&Fog text button.
- 2 Click the Sky Lab button. The Sky Lab palette appears.
- 3 Click the Sun & Moon tab.
- 4 Click the Link Sun to View button.

When this option is enabled, your sun will always remain in the same position relative to the camera. Wherever you move the camera the sun will follow. This is an easy way of seeing how a sunset will look against different skylines.

SUN COLOR

Light in nature is not usually visible until it strikes an object. When you're using normal light, a purple sunlight color will not paint your entire sky purple, but objects in your scene will reflect purple.

When you're using Visible World, choosing purple will paint your entire scene purple.

The grayscale bar at the bottom of the color palette lets you set the intensity of the sun. Black turns the sun off and white sets the sun to its brightest intensity.



You can also use the color palette to set the intensity of the sun. Black represents the lowest intensity and white the highest.

To set the sun color:

- 1 Display the Sky&Fog palette by clicking the Sky&Fog text button.
- 2 Click the Sun Color swatch, and choose a color from the color picker.

Disabling the sunlight

You can remove the sunlight in your scene by disabling it. When the sunlight is disabled, the sun remains in the scene, but does not throw light. The only light visible in your scene comes from individual light sources. (The scene will still be illuminated.)

To disable the sunlight:

- 1 Display the Sky&Fog palette by clicking the Sky&Fog text button.
- 2 Click the Sky Lab button. The Sky Lab palette appears.
- 3 Click the Sun & Moon tab.
- 4 Click the Disable Sun Light button.

WORKING WITH THE MOON

The moon is normally the most prominent object in the night sky. In a night scene it provides all the natural light in the environment. Like the sun, the moon's attributes can greatly affect the final look of your scene.

Its position in the sky affects all the angles and intensities of all the shadows in the scene.

The brightness is affected by the illumination reflected off the earth. The brighter the earthshine, the brighter the moon appears.

Unlike the sun, the moon has phases which simulate the effects of the moon's shadow becoming more or less prominent during a month.

The moon's position and phases can be animated using the Animation controls and the timeline. Refer to "Animating Sun or Moon Position" on page 356 for more on animating the moon.

POSITIONING THE MOON

The moon is positioned at the same time as the Sun. The two are always at opposite ends of the sky, so wherever the sun is positioned, the moon is directly opposite.

In the Sun/Moon control on the Sky & Fog palette, the moon's position is represented by the smaller highlight portion of the Sun Position trackball.

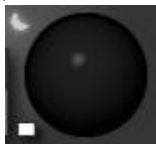

The position of the moon is represented by the smaller highlight portion of the position control trackball. You can position the moon by either moving the smaller highlight or by dragging the sun. The moon is always opposite the sun.

You can position the moon manually by using the Sun/Moon control, or numerically by specifying values in the Sky Lab. You can also position the moon exactly where you want it to appear in your scene.

To position the moon manually:

- 1 Display the Sky&Fog palette by clicking the Sky&Fog button at the top of the Bryce window.

- 2 Drag the smaller highlight area in the Sun/Moon Position control to the position where you want the light to originate.

You can position the sun, or the moon, on the horizon as you like by nudging the Sun/Moon control until the light is visible in your scene.

To position the moon numerically:

- 1 Display the Sky&Fog palette by clicking the Sky&Fog button at the top of the Bryce window.
- 2 Click the Sky Lab button. The Sky Lab palette appears.
- 3 Click the Day/Night toggle to display the moon icon.
- 4 Click the Sun & Moon tab.
- 5 In the Sun Controls area, type a value into the Azimuth field. The Azimuth field controls the east-to-west position of the sun/moon. The range is 0 to +360, and the default value is 60.
 - The moon will be positioned exactly opposite these values, so you can invert them to position the moon numerically, or place the Sun behind the camera so that the moon appears in front of it.
- 6 Enter a value into the Altitude field. The Altitude field controls the height of the sun/moon relative to your scene. The range is -99 to +99.

Positive values are below the horizon, negative values above.

To position the moon with precision:

- 1 Display the Sky&Fog palette by clicking the Sky&Fog button at the top of the Bryce window.
- 2 Click the Day/Night toggle to display the moon icon.
- 3 Hold down Control+Option/Ctrl+Alt, and double-click the Sun control.

- 4 Hold down Shift+Control+Option/Ctrl+Alt, and in the working window, click where you want to position the moon.

MOON PHASES

The moon phases control simulates different aspects of the moon as it orbits the earth.

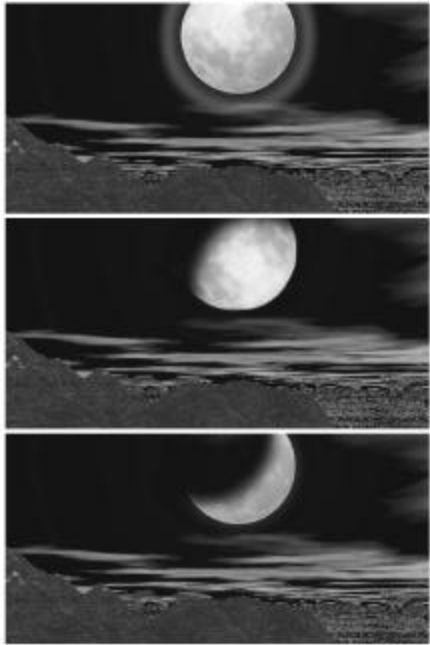

The change in the phases of the moon can indicate the passage of time.

The moon phase is a visual clue to the time of the month. In an animation, you can use the moon phase to simulate the passage of a time. Refer to “Animating Sky & Fog settings” on page 355 for more.

The phase is controlled using the Moon Phase controls in the Sky Lab palette.

TO SET THE MOON’S PHASE:

- 1 Display the Sky&Fog palette by clicking the Sky&Fog button at the top of the Bryce window.

- 2 Click the Sky Lab button. The Sky Lab dialog appears.
- 3 Click the Sun & Moon tab.
- 4 Enable the Moon Phase option.
- 5 Drag over the Moon Phase control. The phase changes as you drag.
- 6 Click the OK icon to exit the dialog.

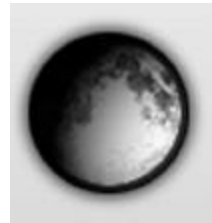

The Moon Phase control lets you set the phases of the moon.

MOON BRIGHTNESS AND SHARPNESS

The moon is directly affected by the light reflected from the earth. The brighter the reflection, the brighter the moon’s shadow. In Bryce this effect is controlled by the Earthshine setting which makes the moon brighter or darker.

A realistic moon does not have sharp edges and may appear blurry on hazy nights. The Softness control lets you set the moon’s edge softness to give a more realistic feel.

TO SET THE BRIGHTNESS OF THE MOON’S SHADOW:

- 1 Display the Sky&Fog palette by clicking the Sky&Fog button at the top of the Bryce window.
- 2 Click the Sky Lab button. The Sky Lab dialog appears.
- 3 Click the Sun & Moon tab.
- 4 Enable the Moon Phase option.
- 5 Drag the Earthshine slider. Drag right to increase the brightness and left to decrease it.
 - Enter a value in the Earthshine field to set Earthshine numerically.

- 6 Click the OK icon to exit the dialog.

To SET THE MOON'S EDGE SOFTNESS:

- 1 Display the Sky&Fog palette by clicking the Sky&Fog button at the top of the Bryce window.
- 2 Click the Sky Lab button. The Sky Lab dialog appears.
- 3 Click the Sun & Moon tab.
- 4 Enable the Moon Phase option.
- 5 Drag over the Softness control. Drag right to soften edges, or left to sharpen them.
 - Enter a value in the Softness field to set Softness numerically.
- 6 Click the OK icon to exit the palette.



In this example, rings have been added to the sun to make the scene look like a sweltering desert.

This effect creates concentric circles around the image of the sun or moon. Using the Sky Lab palette, you can set the radius of the rings and add a secondary ring to increase the effect. The color of the rings is controlled by the color of the sun/moon.

Adding ENVIRONMENTAL EFFECTS

The elements in a sky aren't constant; the sky is always changing, reflecting weather patterns or the time of day. If it rains, there's a rainbow. If it's night, there are stars. If it's sunset, the sun looks bigger. If you look right at the sun on a hazy day, you'll see rings around it. Sometimes, if it's hazy enough you can even see the sunlight streaking out of the clouds. All these illusions are called environmental effects and the Sky Lab palette contains all the controls you'll need to add them to your scene.

SUN/MOON RINGS

If you look directly at the sun on a hazy day, you'll be able to see rings surrounding it. These rings are created by the reflection off ice particles in the air. In Bryce, you can use the Sun/Moon Rings to create this effect.

To Add SUN/MOON RINGS:

- 1 Display the Sky&Fog palette by clicking the Sky&Fog button at the top of the Bryce window.
- 2 Click the Sky Lab button. The Sky Lab dialog appears.
- 3 Click the Sun & Moon tab.
- 4 Enable the Sun/Moon Visible option.
- 5 Enable the Halo Rings option.
- 6 In the Rings area, enter a value in the Intensity field, or drag the slider, to set the brightness of the ring.
- 7 Enter a value in the Radius field, or drag the slider, to set the radius of the ring.

If you want to add a secondary Sun/Moon ring, enable the Secondary Ring option.

SUN/MOON HORIZON ILLUSION

If you've ever watched a sunset, you probably noticed that the sun appeared to get larger as it approached the horizon. The same is true for the moon. At certain times of the month it appears huge. This illusion can be simulated using Sun/Moon size.



The spooky look of this night scene was created by applying a Horizon Illusion.

When the illusion is active, the sun or moon will appear to grow larger as it approaches the horizon.

TO CHANGE THE SIZE OF THE SUN OR MOON AS IT APPROACHES THE HORIZON:

- 1 Display the Sky&Fog palette by clicking the Sky&Fog button at the top of the Bryce window.
- 2 Click the Sky Lab button. The Sky Lab palette appears.
- 3 Click the Sun & Moon tab.
- 4 Enable the Sun/Moon Visible option.
- 5 Enable the Sun/Moon size Option.
- 6 In the Sun/Moon size area, enter a value in the Disk Size field, or drag the slider, to set the overall size of the sun/moon anywhere in the sky.
- 7 Enter a value in the Horizon Illusion field, or drag the slider, to set multiplier used to determine how much larger the sun or moon gets as it approaches the horizon.

RAINBOWS

In the real world rainbows appear after rainstorms as arcs of light displaying all the color in the spectrum. In Bryce a rainbow is an atmospheric effect that can be added to any sky.

A rainbow is only visible if the sun is visible, meaning you can't have a rainbow at night. As well, you can add a secondary rainbow to create the illusion of reflection.

Rainbows are linked to the sun. As the color or intensity of the sun changes, so does the rainbow. In addition, the position of the rainbow in the sky is dependent on the position of the sun.

Rainbows appear to be infinitely distant from the camera. You can't approach them by moving the camera, so the pot of gold is always just out of reach.

TO ADD A RAINBOW TO YOUR SKY:

- 1 Display the Sky&Fog palette by clicking the Sky&Fog button at the top of the Bryce window.
- 2 Click the Sky Lab button. The Sky Lab dialog appears.
- 3 Click the Atmosphere tab.



The Atmosphere tab of the Sky Lab dialog contains all the controls you'll need to create rainbows.

- 4 Enable the Rainbows option.

- 5 Drag the slider or enter a value in Radius field in the Rainbow area. This value sets the width of the rainbow.
- 6 Drag the slider or enter a value in the Opacity field. This controls the rainbow's transparency.

If you want to add a secondary rainbow to your sky, enable the Secondary Bow option.

VOLUMETRIC World

The Volumetric World effect simulates the effects of particles in the air being illuminated by light sources. In Bryce this effect turns all the light sources in your scene into visible light sources.



Normal Environment



Volumetric World

In this example you can see how the Volumetric World effect transforms a scene.

Sunlight also becomes visible, so that any color you applied to the sun appears everywhere in the scene. Visible sunlight is volumetric, meaning that it is affected by all the objects within it.

Although Volumetric World is a very beautiful effect, it's also a time consuming one. It will add considerably to your scene's rendering time.

To add visible sunlight to your scene:

- 1 Display the Sky&Fog palette by clicking the Sky&Fog button at the top of the Bryce window.
- 2 Click the Sky Lab button. The Sky Lab palette appears.
- 3 Click the Atmosphere tab.
- 4 Click the Volumetric World button.
- 5 Drag the Quality slider or enter a value in the Quality field.
- 6 Drag the Density slider or enter a value in the Density field. Higher values result in brighter, more visible sunlight.

STAR FIELDS

Bryce lets you create night skies complete with stars and comets by using the Sky Lab.

Stars appear in the night sky and are affected by the moon's brightness and color. They are also infinitely distant; they do not get closer as you move the camera.



In this example, you can see how the moon affects the color and intensity of the stars around it.

You can create a star field that is based on a randomly generated star map, or a star field based on the stars we see from the Earth.

To add a Star Field based on a Random Star Map:

- 1 Display the Sky&Fog palette by clicking the Sky&Fog button at the top of the Bryce window.
- 2 Click the Sky Lab button. The Sky Lab appears.
- 3 Click the Sun & Moon tab.
- 4 Enable the Celestial option.
- 5 Enable the Random field option. This will create a star field based on a randomly generated star map.

You can get a different random configuration of stars by Option/Alt-clicking the Random Field button. Shift-clicking the Random field button generates the default random star field.

To add a Star Field based on Earth's Star Map:

- 1 Display the Sky&Fog palette by clicking the Sky&Fog button at the top of the Bryce window.
- 2 Click the Sky Lab button. The Sky Lab appears.
- 3 Click the Sun & Moon tab.
- 4 Enable the Celestial option.
- 5 Enable the Custom field option.

Customizing Star Fields

After you have generated your star field, you can customize certain parameters of the star field. You can control the intensity of the stars, the amount of stars that are visible, and the portion of the star field that is visible in your scene.

Star Field Intensity

Changing the intensity of a star field lightens or darkens the visible stars. When you are using a star field based on the stars we see from Earth,

changing the intensity lightens and darkens the stars uniformly; their relative intensities do not change.

To change the intensity of a star field:

- 1 Display the Sky & Fog palette by clicking the Sky & Fog button at the top of the Bryce window.
- 2 Click the Sky Lab button. The Sky Lab appears.
- 3 Click the Sun & Moon tab.
- 4 Enable the Celestial option.
- 5 Enable the Stars option.
- 6 Drag the Intensity slider or enter a value in the Intensity field.

Star Field Amount

You can increase or decrease the number of stars in the star field by changing the Stars Amount. When you change the amount, new stars are not generated. Instead, stars that are usually too dim to see become more visible.

To change the amount of visible stars in a star field:

- 1 Display the Sky & Fog palette by clicking the Sky & Fog button at the top of the Bryce window.
- 2 Click the Sky Lab button. The Sky Lab appears.
- 3 Click the Sun & Moon tab.
- 4 Enable the Celestial option.
- 5 Enable the Stars option.
- 6 Drag the Amount slider or enter a value in the Amount field.

Star Field Position Control

The Star Field Position Control lets you choose which portion of the star field is visible in your scene. The control works like a trackball, with the stars of the northern hemisphere on one side and

the stars of the southern hemisphere on the other. As you drag over the control, the star field moves in the direction you drag.

COMETS

You can add comets to your night skies. Since comets are not a common sight in the night sky, you'll usually only get one or two comets per star field.

To add COMETS TO A NIGHT sky:

- 1 Display the Sky&Fog palette by clicking the Sky&Fog button at the top of the Bryce window.
- 2 Click the Sky Lab button. The Sky Lab palette appears.
- 3 Click the Sun & Moon tab.
- 4 Enable the Celestial option.
- 5 Enable the Comets option.

You can adjust the intensity and amount of comets by dragging the Intensity and Amount sliders or entering a value in the Intensity and Amount fields.

You can only add comets to a star field that is based on a randomly generated star map.

USING THE PRESET SKIES LIBRARY

The Preset Skies Library contains all the preset skies available in Bryce. You can place them in your scene and edit them just as you would another object.

To add A sky FROM THE PRESET SKIES LIBRARY TO YOUR SCENE:

- 1 Click the triangle icon next to the Sky&Fog text button at the top of the Bryce window, or click the arrow next to the preview area in the Sky Lab dialog. The Preset Skies Library appears.

- 2 Click on the preset thumbnails to view preset names and descriptions.
- 3 Click the OK icon to add the selected sky to your scene.

The Sky&Fog palette does not need to be active for you to access the Preset Skies Library.

You can select presets in one motion by clicking and holding the triangle icon, dragging directly to the desired preset, and releasing the mouse button.

ADDING AND DELETING PRESET SKIES

You can add the sky from any open scene to the Preset Skies Library. This is a good way of saving your favorite skies.

To add A sky TO THE PRESET LIBRARY:

- 1 Click the triangle icon next to the Sky&Fog text button at the top of the Bryce environment. The sky from your scene appears in the preview area of The Preset Skies Library dialog.

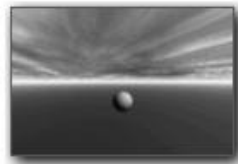

The preview area displays the sky from your scene.

- 2 Click the Add button at the bottom of the dialog. The Add Object dialog appears.
 - 3 Enter a name for the new preset in the Preset Name field.
 - 4 Enter a description of the preset in the Description field and click the OK icon.
- This name and description will appear beneath the object preview whenever the preset is accessed.

You can edit the name and description of any preset at any time simply by pressing the Tab key, or clicking on the name or description.

- 5 Click the OK icon. Your preset will be added to the first available space within the current category.
- 3 Click the Export button at the bottom of the Preset Skies Library dialog. The save file dialog appears.
- 4 Enter a name and location for the file and click Save.

To delete a sky preset:

- 1 Click the triangle icon next to the Sky&Fog text button at the top of the Bryce environment. The Preset Skies Library appears.
- 2 Click on the preset you want to delete, or hold down Shift and select a continuous series of presets, or hold down Command/Ctrl and select a discontinuous set of presets.
- 3 Click the Delete button at the bottom of the Preset Skies Library dialog.

IMPORTING AND EXPORTING PRESET SKIES

Importing and exporting presets is a handy way to exchange custom presets with other users.

To import a preset sky file:

- 1 Click the triangle icon next to the Sky&Fog text button at the top of the Bryce environment. The Preset Skies Library appears.
- 2 Click the Import button at the bottom of the Preset Skies Library dialog. The file open dialog appears.
- 3 Locate the file which you would like to import and click Import.

The contents of the file are placed into the first available space in the current category.

To export a preset sky file:

- 1 Click the triangle icon next to the Sky&Fog text button at the top of the Bryce environment. The Preset Skies Library appears.
- 2 Select the preset or presets you wish to export.



12

CREATING AND EDITING LIGHTS

How much of your scene is visible is determined by the lighting. The position of the light sources in your scene can determine everything from visibility to the time of day to the color of the atmosphere.

LIGHTS

Lighting is what makes your scene visible. Different types of lighting can dramatically alter the appearance of your scene and the objects in the scene.

In Bryce, most of the lighting in your scene is provided by either the sun or the moon. As in nature, the position of the Bryce sun and moon controls the general brightness and ambient color of scenes. Refer to “Working with Sky Lab” on page 243 for more on positioning and setting up the sun and the moon.

You can add additional light sources to create a variety of effects, such as adding headlights to a car, or creating the glare of a distant city.



You can use light sources to shine light from areas where sunlight couldn't shine, like the light from inside a lighthouse.

VIEWING LIGHTS

In Wireframe mode, lighting effects are not visible in the Working window. Instead, all light sources are displayed as wireframes to make it easier for you to edit and position them. Lighting appears in three places: the Nano-Preview, the Shaded Preview mode, and the final rendered scene.

In Nano-Preview, you can see a small preview of your lighting effects while working in Wireframe mode.

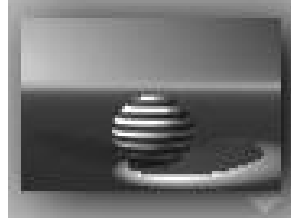

Lighting effects appear in the Nano-Preview.

In Shaded Preview mode, all the objects in your scene appear as flat solids. Any lighting you apply creates simple highlights on the surface of the object. This mode does not show materials.

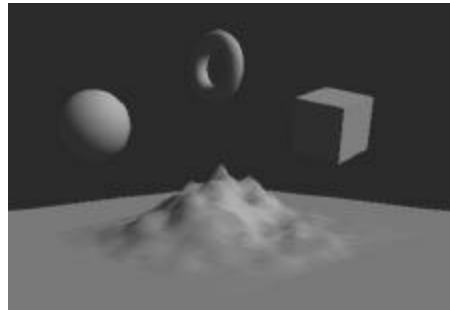

In Shaded Preview mode the objects in your scene are displayed as solids. You can also see the effects of different lighting.

Shaded Preview mode is available only if you have a system that supports OpenGL, SRE 3D, or Direct 3D. Refer to “Display Modes” on page 26 for more on this mode.

If you want to see the effects of lighting on object materials, you'll need to render the final image.

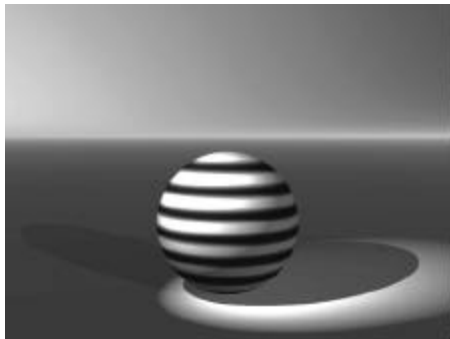

When you render your scene you can see the effects of light position and color on your object's materials.

Visible Lights

One of the most spectacular uses of light sources is visible light. Visible light effects are like cones of light that appear in your scene, such as a searchlight cutting through the fog.

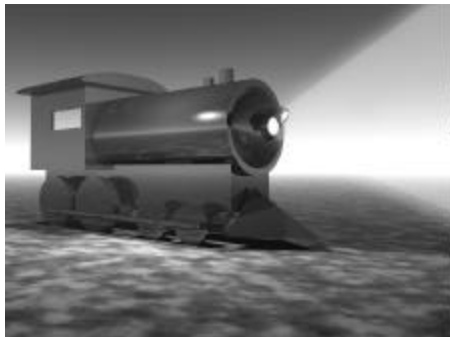

The effect of a searchlight cutting through the fog can be created using a visible light.

There are two types of visible lights: surface visible lights and volume visible lights. Surface visible lights make the light object visible in the scene, but the light does not interact with the environment, so you get a light cone or sphere. Volume visible lights interact with the environment, affect all the objects that they strike, and are directly affected by environment color and brightness. For instance,

volume visible lights can show shadows crossing the air that the light illuminates. Surface visible lights cannot.

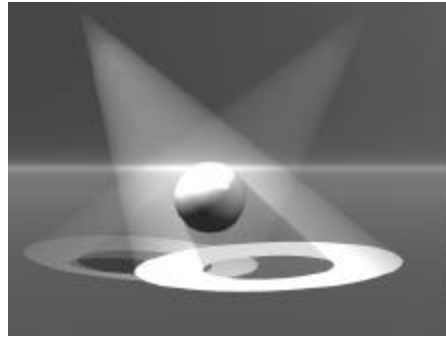

The volume visible light source interact with the other light sources in the scene.

Refer to “Creating Visible Lights” on page 282 for more information on surface and volume visible lights.

SETTING UP LIGHTS

There are two types of lights in Bryce—natural and direct. Natural lighting is provided by the sun. By default every scene contains a sun. Direct light is provided by light sources.

The light from direct light sources can be used to either add hyper realism to natural scenes, or add light to objects that cast light in the scene, like lamps. The lighting setup you choose can greatly affect the look of your scene, so experiment with various lighting setups.

CREATING DIRECT LIGHT SOURCES

There are five types of direct lights you can create: Radial, Spot, Round Parallel, Square Spot, and Parallel.

You can create as many light sources as you need. The only limit is your system's memory. Creating additional lights (or light sources) may add significantly to the render time of your scene.

The size, position, and orientation of a light source can be edited exactly like any other object. Refer to “Transforming Objects” on page206 for more on transforming objects.

You can also link lights to specific objects so that a light source moves as the object moves. You can also set a light to track an object. When it’s tracking an object, the light reorients itself so that it’s always facing the object no matter where it moves. Linking and tracking are quick ways of animating light positions. Refer to “Linking Objects” on page223 for more on linking, and “Tracking Objects” on page344 for more on tracking.

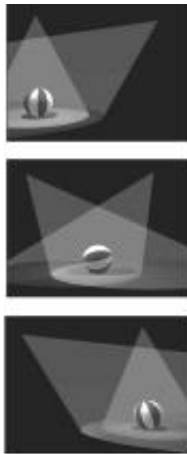

The motion of all the light sources in this example were animated using the track feature.

Light attributes can be edited in the Lighting Lab.

Radial Light

Radial Lights throw light equally in all directions. Use this as a general light source, and remember that you can make these lights as tiny as you like and use as many as you need.

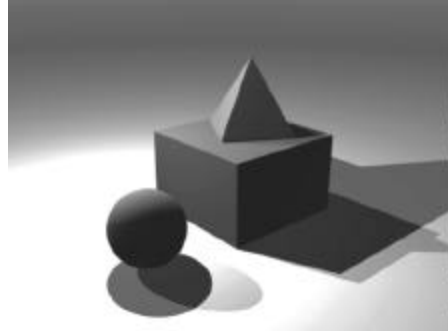

The lighting in this scene was created using a Radial Light.

Spotlight

Spotlights throw light along a cone-shaped path, creating the classic “stage spot” effect.

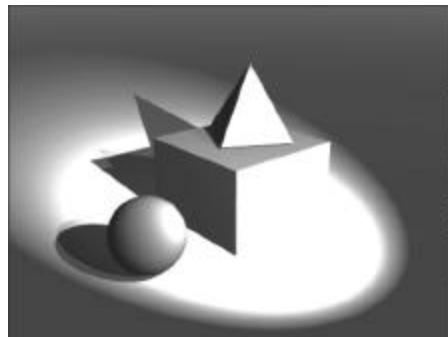

The lighting in this scene was created using a Spotlight.

ROUND PARALLEL LIGHT

Round Parallel Lights produce cylindrical tubes of light and cast circular spots where the light falls.

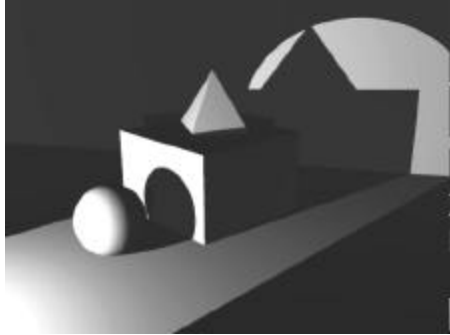

The lighting in this scene was created using a Round Parallel Light.

SQUARE SPOTLIGHT

Square Spotlights are the same as spotlights, except they cast light along a pyramid-shaped path, creating a square spot where the light falls.

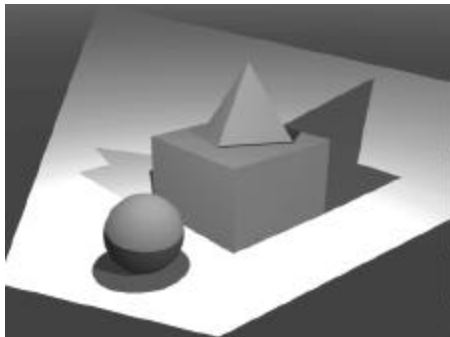

The lighting in this scene was created using a Square Spotlight.

PARALLEL LIGHT

Parallel Lights cast parallel rays, resulting in no spatial distortion of shadows. This type of light is very useful for creating specific shadow patterns, or when used with gels, for creating a slide projector.

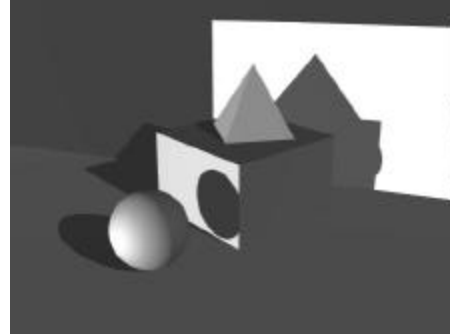

The lighting in this scene was created using a Parallel Light.

TO CREATE A LIGHT SOURCE:

- 1 Make sure the Create palette is visible. If it's not, click the Create button at the top of the Bryce window.
- 2 Click one of the Create light tools:



Creates Radial Lights



Creates Spotlights



Creates Round Parallel Lights



Creates Square Spotlights



Creates Parallel Lights

LIGHTING LAB

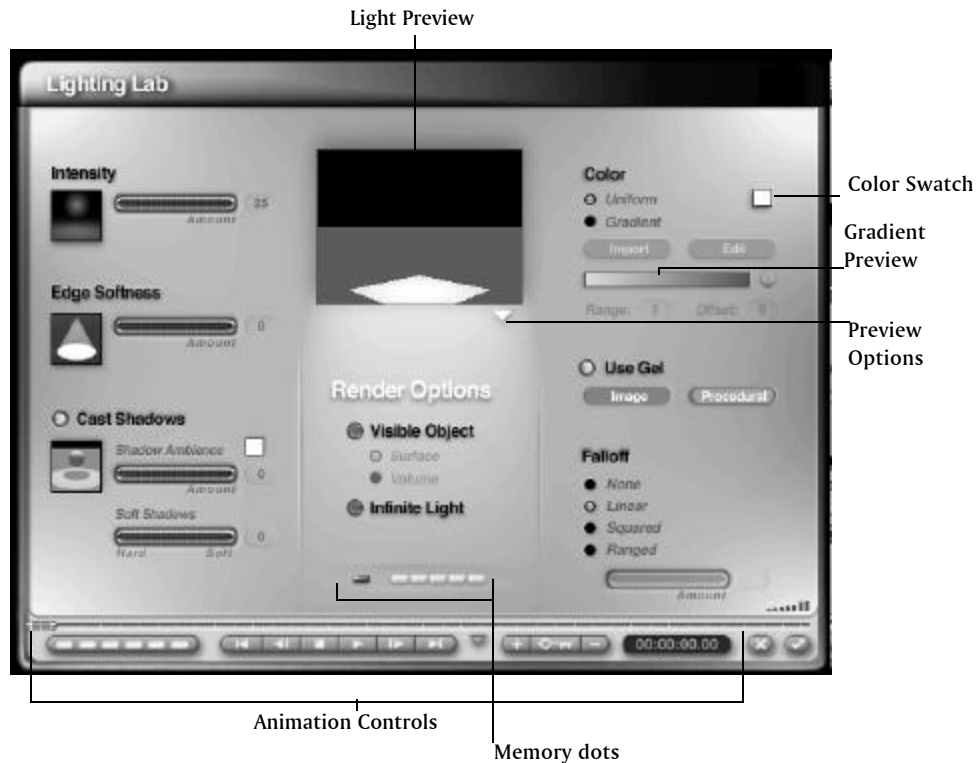

Use the Lighting Lab to set the attributes of your light sources.

You can edit the attributes of a light using the Lighting Lab. For example, you can control the intensity and sharpness of a light source, and change its color and falloff pattern.

TO ACCESS THE LIGHTING LAB:

- 1 Select a light. The Object Controls appear next to the light's bounding box.
- 2 Click the E button.

LIGHT PREVIEW

The Light Preview area displays the effects of any changes you make to the attributes of a light source.

This preview can display the light against a neutral background or show the light in the scene. You can also choose between a faster, low-quality preview, and a slower, high-quality preview.

TO SET THE PREVIEW OPTIONS:

- In the Lighting Lab, click the triangle icon at the bottom right corner of the preview area, and choose a preview option:

Render in Scene displays your scene in the Preview area. This lets you see how the changes you make to the selected light will impact your entire scene.

Render Against Neutral displays the light against a flat background. This lets you isolate the light so you can clearly see subtle changes.

Fast Preview lets you achieve faster updates.

Full Rendering displays a high-quality rendered scene or light.

LIGHT ATTRIBUTES

You can change the intensity of a light source, set its color, and adjust a light's edge softness. When your light source is a spotlight, you can also control the spread of the light.

To adjust light intensity:

- In the Lighting Lab, drag the Light Intensity control.
Drag right to increase light intensity, and left to decrease intensity.

To set a light's color:

- 1 In the Lighting Lab, enable the Uniform option in the Color area.
- 2 Click the Color swatch, and choose a color from the color picker.

By applying a gradient, you can also make a light change color as it travels. Refer to "Gradient Lights" on page 280 for more on gradients.

The Edge Softness attribute lets you set the sharpness/softness of the edges of the spot projected by a light.

To adjust a light's edge softness:

- In the Lighting Lab, drag the Edge Softness control.
Drag left to sharpen the edges, and right to soften the edges.

The spread of the spotlight (also called the Half Angle) controls the size of the projected light cone. The size of the light's wireframe determines the spread of the light. The bigger the wireframe, the larger the spread.

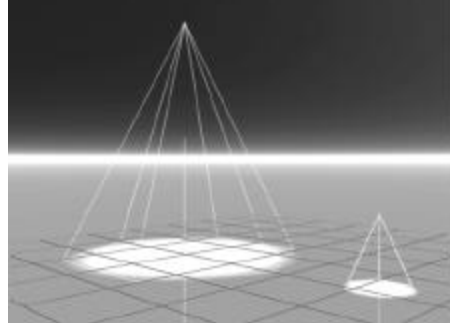

The size of a light's wireframe controls the light's spread.

To adjust the spread of a spotlight:

- 1 Select a spotlight in the Working window.
- 2 Drag one of its bounding box control points to set the wireframe's size.
Increase the size to increase the spread and decrease the size to decrease the spread.

SHADOW AMBIENCE AND SOFTNESS

By default, any light source in Bryce causes objects in its way to cast shadows. You can control the ambience and softness of a shadow to produce realistic-looking shadows or surrealistic effects.

When you change a shadow's ambience, you add a color to the shadow and adjust the amount of the new color in the shadow. When you adjust the softness of a shadow, you blur or sharpen the shadow's edges. Soft shadows blend more smoothly with the background.

You can disable the shadow casting of a light source. This results in a light that illuminates surfaces but does not create shadows.

To change a shadow's ambience:

- 1 In the Lighting Lab, ensure the Cast Shadows option is enabled.
- 2 In the Shadow Ambience area, click the Shadow Color swatch, and choose a color from the color picker.
- 3 Drag the Amount control right to increase the amount of the new color, or left to decrease the amount.

To adjust the softness of a shadow

- 1 In the Lighting Lab, ensure the Cast Shadows option is enabled.
- 2 Drag the Soft Shadows control right to soften the shadow's edges, or left to sharpen them.

To disable shadow casting for a light source:

- In the Lighting Lab, disable the Cast Shadows option.

Light Falloff

Light falloff lets you control the relationship between the intensity of a light and the distance from the light. In the real world, the farther you are from a light source, the less influence it has on the illumination of your surroundings. In other words, the greater the distance, the weaker the light.

In Bryce there are four falloff types you can apply to a light:

- None (No Falloff) causes the intensity of the light to stay the same regardless of the distance.
- Linear Falloff causes the light's intensity to fall off at a constant rate. When you use this type of falloff, the light's range is rather large. This type of falloff is useful for creating outdoor lights like searchlights.
- Squared Falloff causes the light's intensity to fall off rapidly. When you use this type of falloff, the light's range is quite limited. This is useful for creating indoor lights, like lamps.

- Ranged Falloff causes the light to change abruptly from full intensity to zero (no illumination) after a distance range you define.

To set a light's falloff:

- 1 In the Lighting Lab, enable one of the following options: None, Linear, Squared, or Ranged.

To define the range of a light's ranged falloff:

- 1 In the Lighting Lab, enable the Ranged option in the Falloff area.
- 2 Drag the Amount control right to define a greater range, or left to define a smaller range.

GRADIENT LIGHTS

Gradient lights change color as they get further away from the light source, thus coloring surfaces along the way differently. For example, when you apply a red-to-yellow gradient to a light, the resulting gradient light colors nearby surfaces red and distant surfaces yellow. The mid-range surfaces will reflect blends of red and yellow light. This feature is useful for creating custom light falloff patterns.

You can create a gradient in Bryce, or you can import a gradient created with another application. When you create or import a gradient, it is automatically applied to the active light.

To create a gradient:

- In the Lighting Lab, enable the Gradient option in the Color area.

To import a gradient:

- 1 In the Lighting Lab, enable the Gradient option in the Color area.
- 2 Enable the Import option.
- 3 Locate the drive and folder where the gradient file is stored.
- 4 Double-click the filename.

EDITING GRADIENTS

The Lighting Lab lets you control the range and offset of gradients. You can also change a gradient's colors and transparency.

GRADIENT RANGE AND OFFSET

The range of a gradient is the distance in Bryce units that the gradient spans. When a gradient light is this distance from its source, the gradient's end color is applied to the light (provided you've accepted the default offset value of zero).

The offset of a gradient determines how the gradient colors will be applied to the light source. By default, the offset value is zero, which means that the light will start with the start colors of the gradient. When you increase the offset, intermediary gradient colors will be applied to the light at its source. The maximum offset value of 100 results in a light source which begins with the end color of the gradient.

TO CHANGE A GRADIENT'S RANGE:

- In the Lighting Lab, click the Range control in the Color area, and type a value in the field.

TO CHANGE A GRADIENT'S OFFSET:

- In the Lighting Lab, click the Offset control in the Color area, and type a value in the field.

You can also change a gradient's offset by dragging the Offset button next to the Gradient preview.

USING THE EDIT GRADIENT DIALOG

The Edit Gradient dialog lets you edit gradients added to lights. You can change a gradient's colors and transition points, add colors to a gradient, or remove unwanted colors. You can also change the transparency of a gradient to create various light patterns.

The Gradient Preview is automatically updated as you edit a gradient.

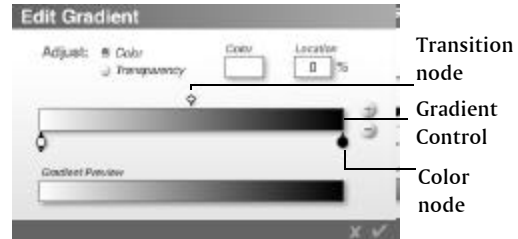

You can modify a gradient light using the controls in the Edit Gradient dialog.

TO MODIFY A GRADIENT'S COLORS:

- 1 In the Lighting Lab, click the Edit button. The Edit Gradient dialog appears.
- 2 In the Adjust area, enable the Color option.
- 3 Click a color node below the Gradient Control. A black arrow displays below the node indicating that the color node is selected.
- 4 Click the Color swatch, and choose a color from the color picker.
- 5 Repeat steps 3 and 4 to modify other colors in the gradient.

A transition point is an imaginary line between two colors in a gradient. Changing the transition point lets you change the ratio between the two colors and produce color blends dominated by one of the two colors.

TO CHANGE A TRANSITION POINT IN A GRADIENT:

- 1 In the Lighting Lab, click the Edit button.
- 2 In the Adjust area, enable the Color option.
- 3 Drag a transition node left to make the end color dominant, or right to make the start color dominant.

You can also change the transition point by typing values in the Location field.

To add colors to a gradient:

- 1 Click the Add (+) button next to the Gradient control. A new color node appears below the center of the Gradient control.
- 2 Click the Color swatch, and choose a color from the color picker.
- 3 Drag the color node left or right to position it.
- 4 Repeat steps 1 to 3 to add other colors.

When you no longer need a color, you can remove it by selecting the corresponding color node below the Gradient box and clicking the Delete (-) button.

By default, all gradients created in Bryce are fully opaque. You can change the transparency of a gradient to create light sources that fade in or out. You can also create complex transparency patterns by adding transparency nodes with various opacity values.

To change the transparency of a gradient:

- 1 In the Lighting Lab, click the Edit button.
- 2 In the Adjust area, enable the Transparency option.
- 3 Click a transparency node below the Transparency control. A triangle appears below the transparency mode indicating that the mode is selected.
- 4 Type a value in the Opacity field.

If you want to adjust the transparency between two transparency nodes in a gradient, drag the transition node above the Transparency control to the left or right.

You can also use the above procedure to change the transparency of imported gradients.

To add transparency nodes:

- 1 In the Lighting Lab, click the Edit button.
- 2 In the Adjust area, enable the Transparency option.

- 3 Click the Add (+) button next to the Transparency box. A new transparency node appears below the center of the Transparency control.
- 4 Type a value in the Opacity field.
- 5 Drag the new transparency node to where you want to change the transparency.

To remove an unwanted transparency change, select the corresponding transparency node and click the Delete (-) button.

CREATING VISIBLE LIGHTS

Visible lights make your light source visible in the scene, like the ball of light that appears around a lamppost on a foggy night.

There are two types of visible lights:

- Surface Visible Lights
- Volume Visible Lights

When you create a surface visible light, the light from the object appears as a semitransparent shape extending from the light source.

Surface Visible lights have the same attributes as non-visible lights, so you can use the Edge Softness control to make the shape that extends from the light fuzzier at the edges, to give it a more realistic feel, or the Falloff options to adjust the range of the light.

The properties within the light are controlled by the default Surface Material applied to the light object. The material can be edited in the Materials Lab. By changing the material, you can change the color of the light, the intensity of the light's color, and many other properties.

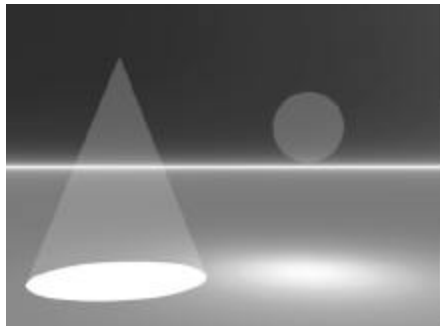

When you create a surface visible light source, it appears as a semitransparent object in the scene.

When you create a Volume Visible light source, a preset Light-sensitive Volume Material is applied to the light source. This makes the light coming from the light source appear visible in the scene, so in the case of a spotlight, the light would appear as a cone. The light also becomes volumetric and reacts to other lights around it. Objects within the cone interact with the light. They can block it, reflect it, etc. Any textures applied to the light also have volume.

The material applied to the object is pre-defined for you, but you can edit its properties in the Materials Lab. By editing the material you can change the light's intensity, color and transparency.

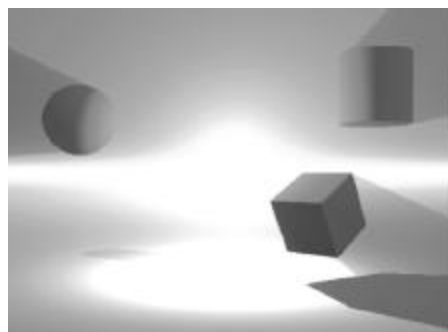

When you create a volume visible light source, the light emanating from the light source is visible in the scene. This light has volume and interacts with the objects inside it.

The real difference between the two types of lights becomes apparent when you apply a gel to the light. In Surface Visible lights, the gel texture is wrapped around the light cone like a skin. Making it semitransparent makes it look more real, but it doesn't make it interact fully with objects inside the cone.

On the other hand, volume visible lights create a real illuminated volume. The texture gel exists everywhere inside the cone, and the objects within the cone are directly affected by the texture. The light also interacts with the surrounding light sources.

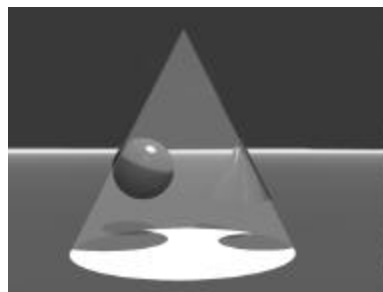

In this example, the same objects were first illuminated by a surface visible light...

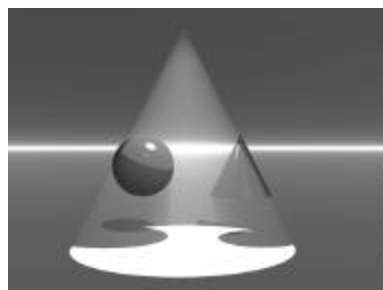

...and then a volume visible light.

It's a good idea to choose to apply the Infinite Light option to both types of visible lights, as this option extends the light's range. This gives the light a more realistic look.

To CREATE A SURFACE visible light:

- 1 Create a light source.

- 2 Select the light in the Working window.
- 3 Click the E button that appears next to the light's bounding box. The Lighting Lab appears.
- 4 In the Render options area, enable the Visible object and Surface options. A number of preset Surface material properties are applied to the light, creating a visible cone of light.
If you want to extend the light's range, enable the Infinite option.

To create a volume visible light:

- 1 Create a light source.
- 2 Select the light in the Working window.
- 3 Click the E button that appears next to the light's bounding box. The Lighting Lab appears.
- 4 In the Render options area, enable the Visible object and Volume options. A number of default Volume material settings are applied to the light source, creating a softer visible cone of light.
If you want to extend the light's range, enable the Infinite option.

Editing Visible Light Materials

The materials applied to a visible light control many of its properties. Although these materials can be edited, just like any other object's material, you should keep in mind that when you're editing a light's material in the Materials Lab, you're changing how the light source will appear in the scene.

Any texture components you apply to the light's material will appear as gels.

For Surface Visible lights, the light's material is a Surface material. For a Volume Visible light the material is a Volume Material.

Refer to "Surface Material Channels" on page133 for more on editing Surface materials, and "Volume Material Channels" on page142 for more on editing Volume materials.

Applying Gels

Gels are filters placed directly in front of lights to change the colors cast by the light, or to cast specific kinds of shadows.

In Bryce, you can use any image or procedural texture as a gel. Once you've assigned a gel to a light source, you'll be able to see the pattern of the gel on any object it shines on. For example, if you apply an image to a Square Spotlight, you can create a slide projector. You can apply an unusual texture across your entire scene by assigning a Texture gel to a Radial Light.

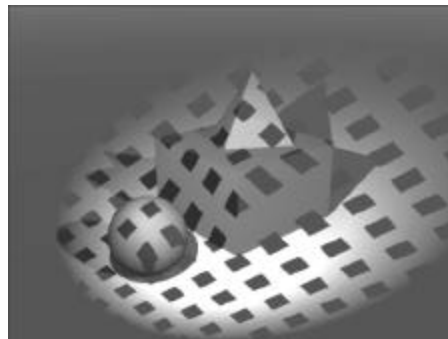

This lighting effect was created using a gel.

When you apply a gel to a visible light, the texture's pattern is visible throughout the visible light.

To use an image as a gel:

- 1 In the Lighting Lab, enable the Use Gel option.
- 2 Click the Image button. The Picture dialog appears.
- 3 Choose an image from the preset library, or click the Load button and load an image.
Refer to "Working with Pictures" on page83 for more on the Picture dialog.

- 4 Click the check mark. The picture is applied as a gel.

TO USE A TEXTURE AS A GEL:

- 1 In the Lighting Lab, enable the Use Gel option.
- 2 Click the Procedural button.
- 3 The Preset Materials Library appears.
- 4 Select a material from one of the categories available.

Refer to “Using the Materials Presets Library” on page 164 for more on the Preset Materials Library.

- 5 Click the check mark. The texture in the material is applied as a gel.

To use a texture as a Gel, you must select a preset that contains a texture. Preset materials that contain only color or optic information (such as many found in the Simple & Fast category) will have no effect.

If you selected a color other than white in the Lighting Lab, that color overrides colors from Texture gels. However, the luminance patterns are still used.

SAVING LIGHT SETTINGS

You can save up to five light settings using Memory dots. This feature lets you experiment safely with various light attributes without losing your favorite light effects.

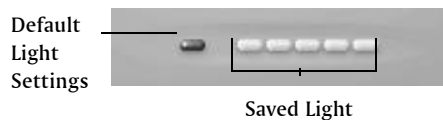

You can use Memory dots to save light settings.

You can switch between different saved light settings to compare them. Also, you can reset the light settings to default at any time. When you no longer need a configuration of light settings, you can delete it.

TO SAVE LIGHT SETTINGS TO A MEMORY DOT:

- Click an empty memory dot. Empty dots appear grey. Full dots appear blue.

TO SWITCH BETWEEN SAVED LIGHT SETTINGS:

- Click a full (blue) dot. Active dots appear blue with a white dot in the middle.

TO RESET LIGHT SETTINGS TO DEFAULT:

- Click the default memory dot. The default memory dot stands apart from the rest.

TO DELETE SAVED LIGHT SETTINGS:

- Option/Alt-click a full dot. The dot turns gray.

POSITIONING LIGHTS

Light wireframes can be edited exactly like any other object, either directly in the scene using its bounding box, or indirectly using the tools in the Edit palette.

Refer to “Positioning Objects” on page 214 for more on positioning objects.

LINKING AND TRACKING WITH LIGHTS

Since lights act just like other objects, you can link them to other objects, or have them track other objects in the scene.

In an animation, lights that track an object can create some very complex lighting effects.

Refer to “Linking Objects” on page 223 for more on linking, and “Tracking Objects” on page 344 for more on tracking.

ANIMATING LIGHTS

You can animate lights by using the animation controls in the Lighting Lab. For example, you can animate a light’s edge softness and intensity.

Refer to “Animating” on page 319 for more on animation controls.

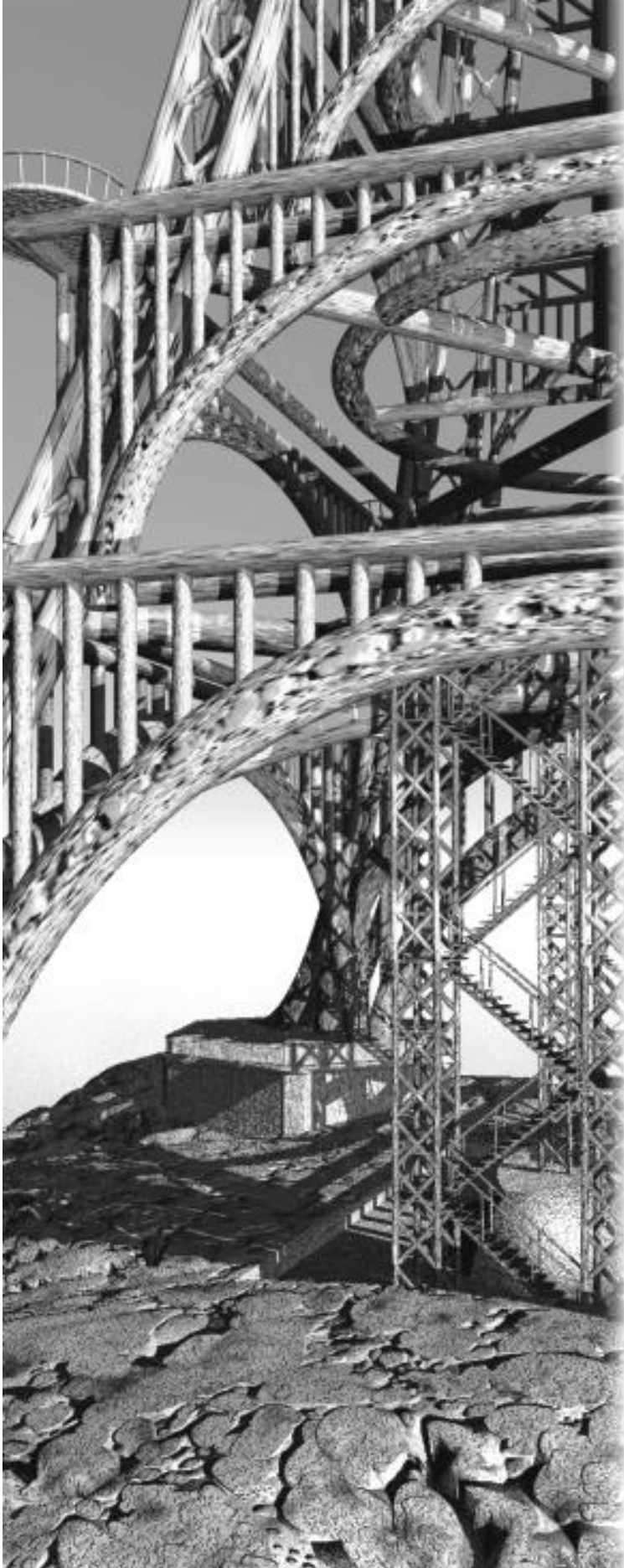

13

USING THE CAMERA

You can think of the view of your scene as a window to a whole new world. The view you see through this virtual window is determined by the orientation and position of a camera. As you move the camera, you get a different view of your world.

THE VIEW OF YOUR SCENE

The view of your scene refers to the portion of the scene visible in the Working window. There are eight views of your scene available in Bryce: the *Camera View*, which is the view produced by the Camera in the scene; the *Director's View*, which shows your scene from the perspective of a director sitting outside of the scene; and the *orthogonal views* (Top, Bottom, Left, Right, Back and Front) which are perspective-free views of your scene.

CAMERA VIEW

Camera View is produced by the Camera in 3D space, meaning that you can view your scene from anywhere within your Bryce environment—even from underneath it. The Camera View can be positioned using the positioning tools or by repositioning the Camera in the scene.

The Camera has a wireframe, which can be dragged in the Working window and its motions recorded as an animation. However, the wireframe is visible only in the Director's View or one of the orthogonal views.

DIRECTOR'S VIEW

The Director's View gives you the freedom to look at your scene from any perspective, while still being able to manipulate the Camera as an object.

The Director's View motions are not recorded as part of an animation. This means that you can move to any position without inadvertently changing the view of your scene in the animation. The Director's View can also be an invaluable tool for animating the view of your scene. While in this view, you can select the Camera and reposition it anywhere in the scene to create camera motions.

Director's View is the default view of the scene.

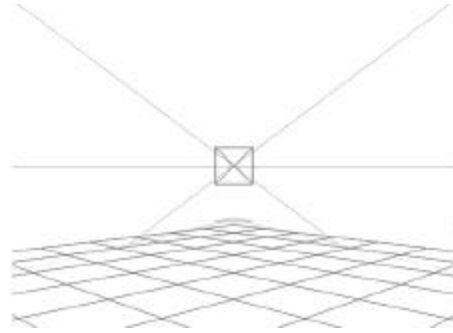

This is what your scene looks like when you view it in Director's View.

ORTHOGONAL VIEWS

These six views let you see the scene from all sides. They do not show you any perspective, but you can see all the objects in the scene, including the camera.

These views are only flat projections of the scene, so you can't move around them using the camera controls.

SETTING UP THE VIEW OF YOUR SCENE

There are eight different views of your scene available in Bryce: Camera View, Director's View, and the six orthogonal views. The Camera View and Director's View let you see the scene from any perspective, while the orthogonal views let you see projections of the scene from the top, bottom, left, right, front and back.

To choose a view:

- Click the triangle icon next to the View Control icon and choose a view from the menu.

CAMERA VIEW

This view of your scene in the Working window is seen through the lens of the Camera object in your scene.

Since your scene exists in 3D, you can view it from any vantage point: above, below, or even from inside an object. To see from these different perspectives, you change the position of the Camera. The positioning tools available in the Control palette let you position the Camera along specific axes and change its orientation.

As you create and position the objects in your scene, you can use the position and orientation of the camera (called Camera Space) as a reference for several transformation operations. You can rotate, position and resize objects using Camera Space. Refer to “Camera Space” on page203 for more information.

When you’ve completed your scene, the Camera View can be used to create the final rendered image or animation. You can reposition the camera and render the scene from several different viewpoints.

The camera can also be animated just like any other object. You can record changes in its position at different points along the timeline. When you run the animation, the view from your camera appears to change like the view seen from an airplane as it flies through a landscape. Refer to “Animating the Camera” on page346 for more on animating the camera.

When you’re in Camera View, a small camera icon appears in the View control.



The camera icon in the View control indicates that you’re in Camera View.

To switch to Camera View:

- Click the triangle icon next to the View Control icon and choose Camera View from the menu.
- or
- Click and drag over the View Control until the Camera icon appears.

SETTING CAMERA OBJECT PROPERTIES

Since the Camera acts as an object, there are several object properties you can use to set how it’s displayed, linked, or animated. Refer to “Editing Link Attributes” on page235 for more on linking properties and “Editing Animation Attributes” on page236 for more on Animation properties.

You can hide the camera wireframe to get a better view of objects in your scene. When you want to change the camera properties, you can display the hidden camera wireframe. Also, you can lock the position of the camera.

To hide the camera wireframe:

- 1 Switch to Director’s View or an orthogonal view so you can see the camera’s wireframe.
- 2 Select the camera in the Working window.
- 3 Click the A icon that appears next to it. The Camera & 2D Projection dialog appears.
- 4 Enable the Invisible option.

To display the hidden camera wireframe:

- 1 Click the Time\Selection Palette toggle at the bottom-right corner of the Working window to display the Selection palette.
- 2 Click the triangle icon on the Selection palette, and choose Select camera.

To lock the camera position:

- 1 Switch to Director’s View or an orthogonal view so you can see the camera’s wireframe.
- 2 Select the camera in the Working window.

- 3 Click the A icon that appears next to its bounding box. The Camera & 2D Projection dialog appears.
- 4 Enable the Locked option.

DIRECTOR'S VIEW

Director's View lets you view your Bryce environment through the eyes of a director sitting outside the scene and directing the action of all the objects—including the camera. The camera that generates the Director's View cannot be seen or positioned like an object. You have to use the positioning controls to move this view. Unlike the Camera View, the motion of this view cannot be recorded as part of an animation.

When you're working on a still image, you can use Director's View to get a second perspective on your scene. You can also render the Director's View of your image.

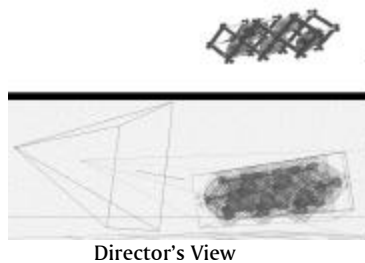
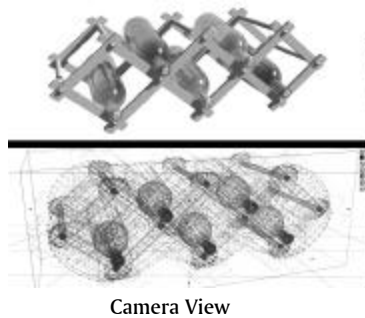

In a still image, you can use both the Director's View and the Camera View to get different perspectives of your scene.

The real power of the Director's View becomes obvious when you're working on camera animations. Animating camera motions while in Camera View can be tricky. However, in Director's View you can see the camera as an object, which means that you can set up camera motion just as you would any other object.

To switch to Director's View:

- Click the triangle icon next to the View Control icon and choose Director's View from the menu.

SWAPPING DIRECTOR'S VIEW FOR CAMERA VIEW

The Director's View and the Camera View are interchangeable. So you can move the Camera View to the position of the Director's View, or vice versa.

Even though you can't directly position the camera that produces the Director's View in the Working window, you can set up a Director's camera position by dragging the Camera to a position in the scene and then swapping the Camera position with the Director's View position.

To swap the Director's View position for the Camera View position:

- Click the triangle icon next to the Camera Axes controls and choose either Camera to Director or Director to Camera from the menu.

ORTHOGONAL VIEWS

There are six other views available through the View controls, but these views are not generated by any camera. The views (Top, Bottom, Left, Right, Back and Front) are perspective-free views of your scene called *orthogonal projections*. When you're using one of these views, you cannot use the Camera controls.

Refer to "Orthogonality and Views" on page 21 more on orthogonal views.

The orthogonal views are another way of seeing the camera as an object in the scene. This can be invaluable when you're animating the camera, or setting up a complex scene.

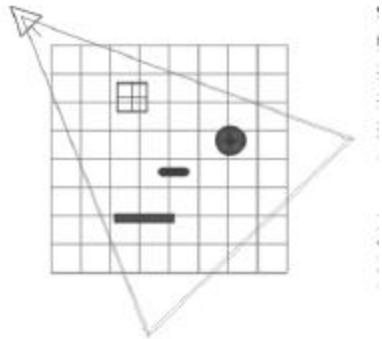

Using the orthogonal views, you can quickly move to different views of your scene. These views also let you see the camera as an object.

POSITIONING THE VIEW OF YOUR SCENE

When you position a view, you're affecting the location and orientation of a camera, not the scene itself. The scale and position of objects remains constant; only your view of the scene changes.

The controls described in this section can be used to position either the Camera View or the Director's View. However, some controls, like the Trackball, are limited when you're in Camera View.

Bryce has two sets of controls for positioning your view of the scene: the Trackball and the Camera controls.

The Trackball lets you adjust the position of the camera, as well as its orientation.



Use the Trackball to adjust the camera's position.

The Camera controls change the position of the camera along the X, Y, and Z axes.

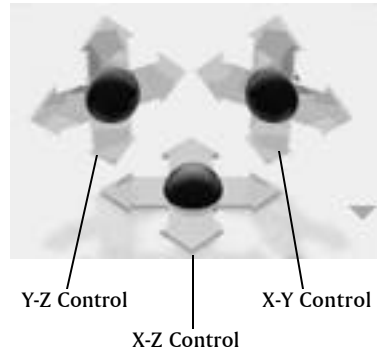

The Camera controls let you adjust the position of the camera along the X, Y and Z axes.

CAMERA MODES

The cameras in Bryce have four modes that affect the behavior of the Trackball. Three of the modes are available only when you're in Director's View. The only mode available in Camera View is Free Camera.

TRACKBALL MODE

In this mode the camera orbits around your scene. The center of the orbit, or origin, is the center point of a box that encompasses all the objects in your scene.

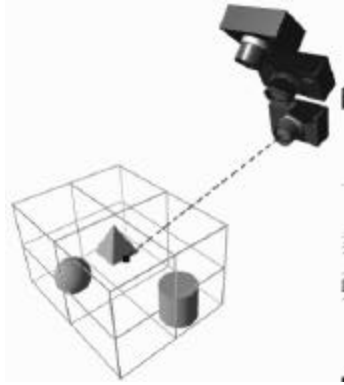

In Trackball mode the camera orbits around the center point of a box that surrounds all the objects in your scene.

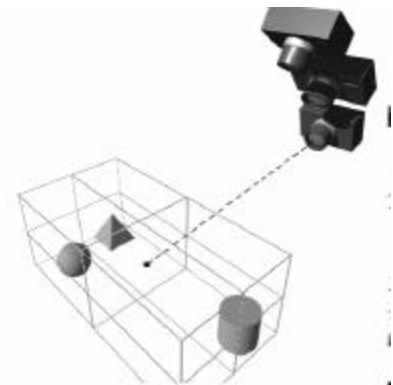

When the size of your scene changes, so does the center of rotation of the camera.

As the size of your scene changes, so does the size of the box, which changes the box's center point. As a result, the center of rotation for the camera also changes as you change the size of your scene. In fact, in this mode the camera's center of rotation is constantly updated, so that it always remains in the center of the scene.

CENTER TO SELECTION MODE

In this mode the camera also orbits around the scene. The center of the orbit, in this mode, is a selected object. As the object moves, so does the

camera's center of rotation. This mode is the best way of making sure that specific objects always remain in view.

TRIPOD MODE

In this mode the center of rotation is fixed at the center of the camera, so it actually pivots in place. As the name suggests, the camera acts as though it's on a tripod. It can rotate around, or tilt up and down, but it always remains in place.

Use the Tripod mode in conjunction with the Eye Level Camera command to get a sense of height. Refer to "Camera Axes Control Options" on page 294 for more on this command.

FREE CAMERA MODE

In this mode the camera is completely unconstrained. Its center of rotation can exist anywhere, from its center to a point somewhere in the scene. Since the placement of the camera's center of rotation is not limited, this mode can simulate any of the other modes. For example, if you place the camera's origin point in its center, it acts as though it's on a tripod.



In Free mode the camera can move to any point and can rotate around its center or any other point in the scene.

Refer to "Manually Positioning the Camera" on page 297 for more on positioning the camera's origin point.

To choose a camera mode:

- 1 Double-click either the Trackball or one of the Camera controls. The Camera & 2D Projection dialog appears.
- 2 Make sure the General tab is visible.
- 3 Click one of the mode buttons at the top of the dialog.

You can also switch between modes by clicking the triangle icon next to the Trackball and choosing a mode from the menu.

Using the Trackball

The Trackball lets you rotate the camera around its origin point. The position of the origin depends on the Camera mode you select. Refer to “Camera Modes” on page291 for more on these modes.

The Trackball doesn’t rotate the scene, it only changes the camera’s location (Offset) and orientation (Rotation) relative to your scene.

To move the camera using the Camera Trackball:

- Drag the mouse over the Camera Trackball control. The view of your scene moves in the direction you drag.

Using the Camera Axes Controls

Camera Axes controls let you move the view of your scene along specific axes. When you’re using these controls, the view does not tilt or rotate from its original position. It only moves up, down, back or forward.

The Camera Axes controls affect your camera’s location (Offset) only, not its orientation (Rotation).

Camera Axes controls are not available if you are in any Orthogonal View. When unavailable, these controls turn dark grey. If you are in an Orthogonal View, you must use the Zoom and Pan tools for navi-

gation. Refer to “Orthogonality and Views” on page21 for more on these views.

There are three Camera Axes controls available:

X-Y CAMERA CONTROL

The X-Y Camera control provides control for horizontal and vertical motion. The sphere at the center of the camera control lets you move the camera along both the X and Y axes. The arrows let you constrain movement either horizontally or vertically.

X-Z CAMERA CONTROL

The X-Z Camera control provides control for horizontal and depth motion. The sphere at the center of the camera control lets you move the camera in both the X and Z axes.

Y-Z CAMERA CONTROL

The Y-Z Camera control provides control for vertical and depth motion. The sphere at the center of the camera control lets you move the camera in both the Y and Z axis.

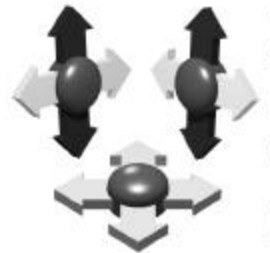

Use these controls to move the camera along the Y axis.



Use these controls to move the camera along the X axis.

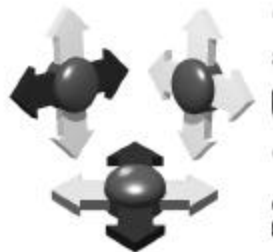

Use these controls to move the camera along the Z axis.

TO MOVE THE CAMERA ALONG TWO AXES AT ONCE:

- Drag the sphere at the center of one of the Camera controls. The cursor becomes a four-way arrow.

The motion of your mouse determines the direction of the camera movement:

X-Y Camera control: moving up, down, left and to the right, moves the camera up, down, left and right.

X-Z Camera control: moving up, down, left and right moves the camera backward, forward, left, and right.

Y-Z Camera control: moving up, down, left and right, moves the camera up, down, forward, and backward.

TO MOVE THE CAMERA ALONG A SINGLE AXIS:

- Drag along the tip of an arrow.

When you move the cursor over an arrow point, it changes to a letter to identify the axis of constraint.

CAMERA AXES CONTROL OPTIONS

The Camera Axes controls have options that let you move the camera to create specific views.

To choose a CAMERA AXES CONTROL option:

- Click the triangle icon next to the Camera Axes controls and choose an option from the menu:

Center Scene rotates the camera so that all items in your scene are centered in the Working window. This option affects only the camera's rotation, not its offset. If you can't see all the objects in your scene after using this option, try pulling your camera back a bit with one of the Z controls.

Center Selection rotates your camera so that any selected object or objects will be centered in your view. This option does not reposition the object itself, only the camera's rotation relative to the selected object.

Eye Level Camera repositions the camera to just above ground level. Use this command (especially in conjunction with the Trackball's Tripod mode) to create the feeling of large, looming mountains or other objects. This is also effective in concert with the Field of View control.

Choose Camera to Director or Director to Camera to select either the Director or Camera View.

Edit Current Camera brings up a dialog that allows you to enter current camera information. Refer to "Positioning the Camera Numerically" on page 296 for more information.

BANKING CONTROLS

The Banking control sphere tilts your Camera (actually rotating the camera on the Z axis), creating the effect of a tilted horizon. This control is great for creating tilted airplane cockpit views. Banking simulates a Roll action.

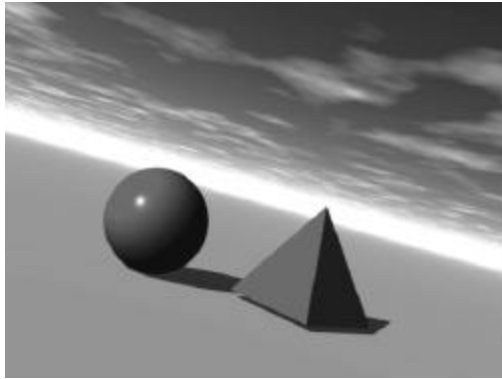

This scene was created by banking the camera.

TO BANK THE CAMERA:

- Drag the Banking control, which is located to the top left of the Camera Trackball. Drag right to bank to the right and left to bank to the left.
Press Option/Alt-click in this control to reset to normal. The normal (default) setting is zero.

Field of View

The Field of View control sphere acts like a zoom lens control. The higher the setting, the wider the field of view for your lens.

Because you are admitting more information into your lens, it will create the illusion that objects are receding from view, or getting smaller. That is not the case. Since you're admitting more information, existing objects necessarily occupy a smaller percentage of space within your field of view.

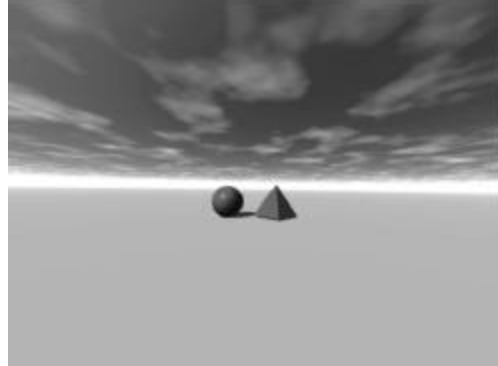

This scene was created by increasing the camera's field of view.

If you drag the Camera Z control to bring your "receding" objects back up to a larger area in your view, perspective distortion effects appear. This is particularly effective for creating broad, swooping cloud scenes.

When you view the camera in Director's View or one of the orthogonal views, you'll be able to see the camera's Field of View displayed as a 3D pyramid that extends from the camera wireframe.

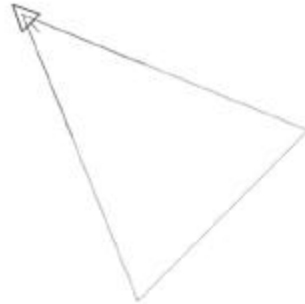

The large triangle that extends from the camera's wireframe represents its field of view. As the field of view changes, so does the shape of the triangle.

TO DISPLAY THE CAMERA'S FIELD OF VIEW:

- 1 Switch to Director's View or an orthogonal view so you can see the camera's wireframe.
- 2 Select the camera in the Working window.

- 3 Click the A icon that appears next to the camera object. The Camera & 2D Projection dialog appears.
- 4 Enable the Show FOV option.

To INCREASE/DECREASE THE CAMERA'S field of view:

- Drag the Field of View control. Drag right to increase the field of view and left to decrease it.
Option/Alt-click on this control to reset to normal. The normal, or default, setting is 60°.

POSITIONING THE CAMERA NUMERICALLY

The most precise way of positioning the view of your scene is by using the Camera & 2D Projection dialog. This dialog lets you enter values to set the camera position, the position of the camera's origin point, rotation, and field of view. The dialog can be used to adjust either the Camera View or the Director's View.

When you display the dialog, you can see the numerical position of the camera and the position of its origin point. You can also see the active Camera Mode.



The Camera & 2D Projection dialog lets you view and set the attributes of the current camera.

There are different options available in the dialog depending on whether you're in Camera View or Director's View. When you're in Camera View, the only Camera Mode available is Free Camera. As well, the Origin fields are only available if you're using Free Mode.

Since the camera is an object, there are several more controls available when you're in Camera View. These controls let you set linking and animation options. Refer to "Camera Modes" on page 291 for more.

To position the CAMERA'S ORIGIN POINT NUMERICALLY:

- 1 Double-click either the Trackball or one of the Camera controls. The Camera & 2D Projection dialog appears.
- 2 With the Camera View active, make sure the General tab is visible.
- 3 Click the Free Mode button.
- 4 Enter values in the Origin X, Y, and Z fields.

To SET THE POSITION OF THE CAMERA NUMERICALLY:

- 1 Double-click either the Trackball or one of the Camera controls. The Camera & 2D Projection dialog appears.
- 2 With the Camera View active, make sure the General tab is visible.
- 3 Enter values in the Position X, Y, and Z fields.

You can enter negative values here. Technically, since the Bryce environment is infinite, the range is infinite as well, but higher values can create unpredictable results. The default values are 102.40, 30.72, and 102.40, respectively.

To ROTATE THE CAMERA NUMERICALLY:

- 1 Double-click either the Trackball or one of the Camera controls. The Camera & 2D Projection dialog appears.

- 2 With the Camera View active, make sure the General tab is visible.
- 3 Enter values in the Rotate X, Y and Z fields. Values are expressed in degrees.

X, Y, and Z rotations are also known as Yaw, Pitch and Roll. The Z rotation, or Rollfield, displays the current value for the Banking control.

You can enter negative values in these fields. The effective range is +/- 999. Default values are 0, 135, and 0°, respectively.

TO SET THE FIELD OF VIEW NUMERICALLY:

- 1 Double-click either the Trackball or one of the Camera controls. The Camera & 2D Projection dialog appears.
- 2 With the Camera View active, make sure the General tab is visible.
- 3 Enter a value in the Field of View field (FOV).
The value in this field, expressed in degrees, describes current settings for the Field of View control. The effective range is 1 to 180°, and the default value is 60°.

MANUALLY POSITIONING THE CAMERA

You can manually position the camera by adjusting the position of the camera wireframe in the Working window. The camera wireframe is visible only when you're in Director's View or one of the orthogonal views.

In the Director's View, or an orthogonal view, you will see a blue Camera wireframe, which represents the location of your Camera. You can then drag the Camera wireframe to change the Camera position. The Nano-Preview updates to reflect your changes.

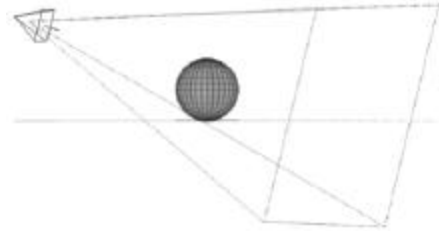

The camera indicator appears only in the orthogonal views and the Director's View. Drag the indicator to adjust the camera's position.

CAMERA ORIGIN POINT

In its default state, the Camera's origin point is not visible and is located at its center.

When the Camera's origin point is visible, it appears as a green dot in the center of the camera's wireframe.

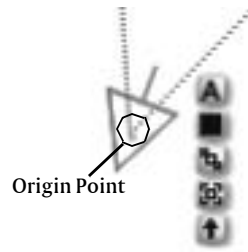

The green dot in the center of the camera wireframe represents its origin point.

You can simulate any of the camera modes by dragging the camera's origin point to different locations in the scene:

- If you position the origin point in the center of the scene, the camera acts as though it's in Trackball mode. When you rotate the camera, it moves around the origin point.
- If you position the origin point over an object in the scene, it acts as though it's in Center to Selection mode. When you rotate the camera object, it will pivot around the object under the origin point.

- If you leave the origin point positioned at the center of the camera object, it acts as though it's in Tripod mode.

Once you offset the origin point, all the camera's movements will be altered. If you, then, switch to Camera View, the camera may not move as expected.

To position the camera manually:

- 1 Switch to Director's View or an orthogonal view.
 - 2 Drag the camera wireframe to a location in the scene.
- or
- Click the camera wireframe and use the tools in the Edit palette to move, or rotate it.

To display the camera's origin point:

- 1 Switch to one of the orthogonal views or Director's View.
- 2 Click the camera wireframe.
- 3 Click the A icon that appears next to the camera's wireframe. The Camera & 2D Projection dialog appears.
- 4 Click the General tab and enable the Show Origin Handle option.

To position the camera's origin point manually:

- 1 In the Camera & 2D Projection dialog, display the camera's origin point.
- 2 Drag the green point to a location in the scene.

Hold down Shift and click the origin point to reset it to the center of the camera object.

AIMING THE CAMERA

The only problem with positioning the Camera using the Orthogonal or Director's View is that the view from the Camera remains fixed as you adjust

its location, so you may inadvertently lose the objects you were looking at when the position of the Camera changes.

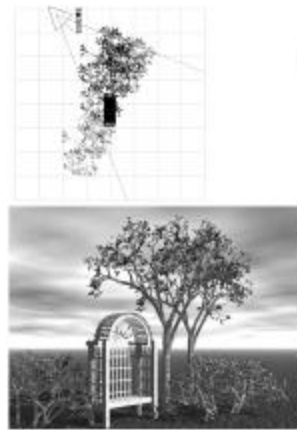

For example, at the beginning of this animation the Camera is pointing at the object in the center of the scene. The view from the Camera shows all the main objects in the scene.

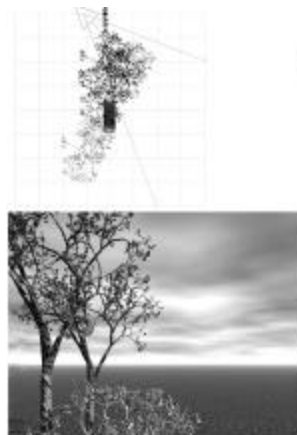

When you move the Camera, it's still pointing in the same direction but from its new position, only one of the objects in the scene is visible.

To solve this problem, Bryce lets you adjust the aim of the camera as you adjust its position.

When you look at the Camera as an object, you'll see that there is a control handle extending from the front of the object. This handle represents the Camera's current aim. By dragging this handle to a point in your scene, you can change the Camera's aim.



The handle that extends from the front of the Camera lets you aim the camera.

When you change the aim of the Camera, it rotates to face the new target, but remains in the same position.

TO CHANGE THE CAMERA'S AIM IN AN ORTHOGONAL VIEW:

- 1 In the Working window, click the triangle icon next to the View Control and choose top, left, right, bottom, front or back from the menu.
- 2 Drag the end of the control handle to the point in your scene where you want the camera to aim.

As you drag, the end of the handle changes to a red dot so you can see the aiming point better.

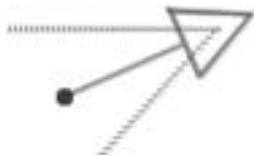

As you drag the end of the camera's control handle, it changes to a dot. The dot represents the point where the camera will aim.

SAVING CAMERA POSITIONS

You can save your favorite camera positions using the Memory dots. The dots let you store up to seven different views of your scene.

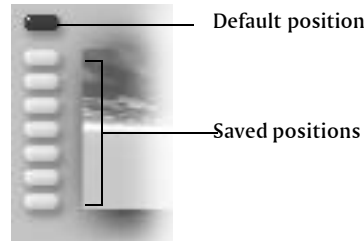

Memory dots let you save views of your scene for later use.

The uppermost dot, slightly separated from the rest, is a quick way to return to the default Bryce camera position. There is no way to clear this dot. It will always contain the default Camera settings.

Dot settings are saved with your scene file, so if you open a previously saved scene, your dot settings from the previous session remain in place.

When you click on a full dot to activate it, the saved position becomes the current Camera View. When you no longer need a saved camera position, you can delete it by clearing the dot it is saved to.

TO SAVE A CAMERA POSITION TO A MEMORY DOT:

- Click an empty dot. Empty dots appear gray. Full dots appear blue.

TO RETURN TO THE DEFAULT CAMERA POSITION:

- Click the top memory dot.
The view returns to the default, regardless of how many changes you've made.

TO SWITCH BETWEEN SAVED POSITIONS:

- Click a full (blue) dot.
Active dots appear blue with a white dot in the middle.

TO CLEAR A FULL DOT:

- Option/Alt-click a full dot. The dot turns gray.

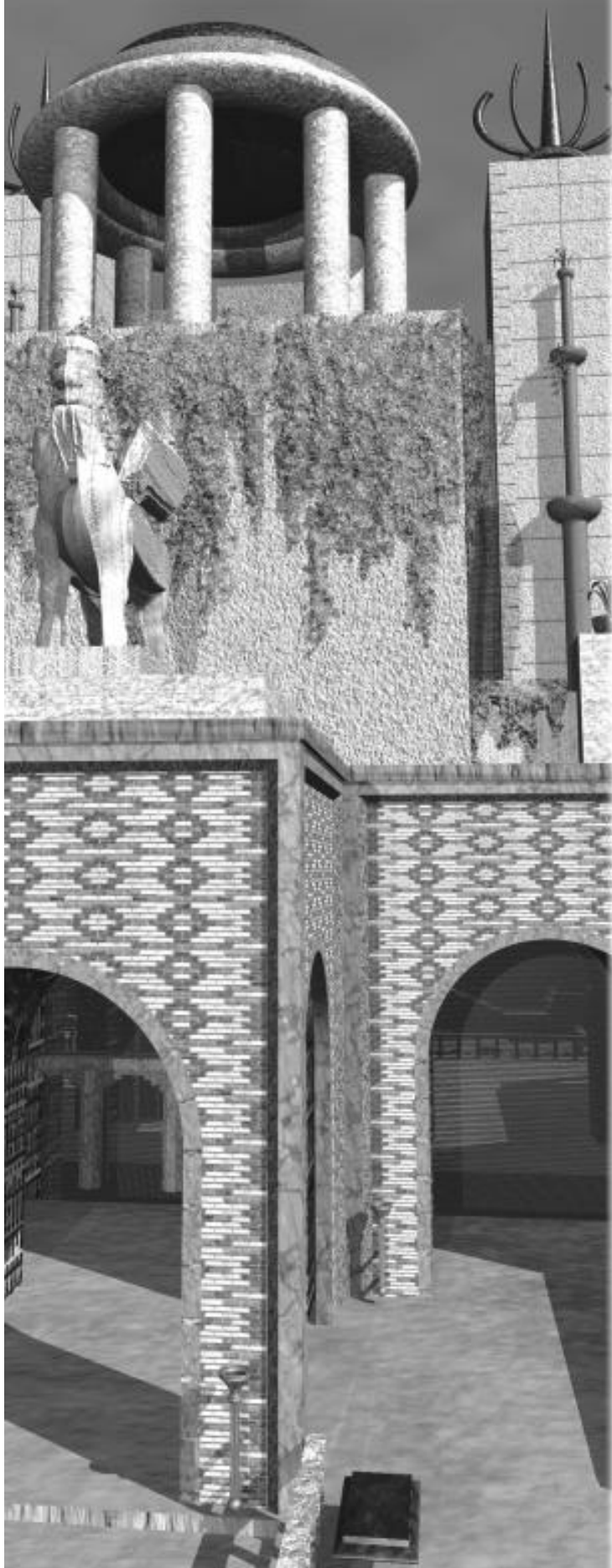

14

RENDERING

Rendering is the process of capturing a view of your 3D scene and displaying it as a 2D image. Once you've rendered the image, it can be used in other image editing or page-layout applications.

Rendering in Bryce uses multiple passes to generate the final rendered image. On the first pass, the image is rendered in large pixel blocks, and then, in successive passes is refined to produce finer detail. The final pass of the rendering is an anti-aliasing pass.

Using this method you can see how the final image will look. Things like colors and light/object placement are very easy to see even during the first pass or two.

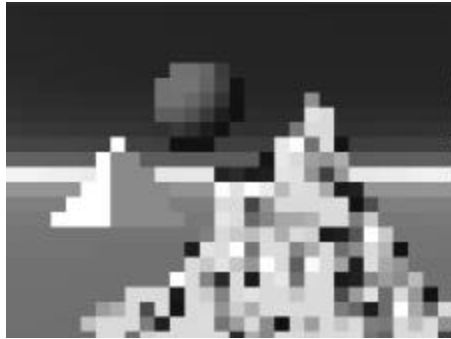

Bryce renders images using multiple passes. On the first pass object placement and color are easily visible...

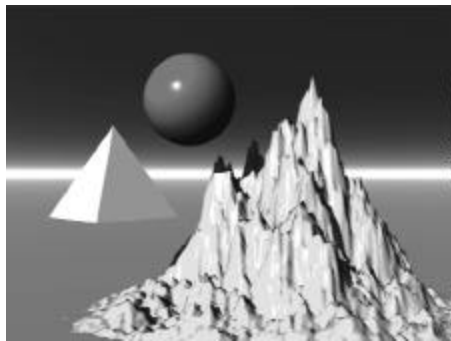

...on successive passes, the image becomes more refined.

Rendering an image requires a great deal of computation. Scenes with multiple terrains (at 512x512 each or more) can generate hundreds of thousands of height points. This can yield millions of polygons to hit with rays. Animations with many frames can require even more computation to render. The more complex the scene or animation, the more computational power is required for rendering, and the longer rendering can take.

RAYTRACING

Bryce renders images using a technique known as *Raytracing*. In the case of a photograph, any given pixel's color is the result of light coming from a scene, through a lens, and onto the film. Raytracing does the inverse. Virtual rays of light are shot from

the virtual "film" through a mathematical "camera" and out into a 3D scene. As they pass through the scene, these rays collide with objects. The object they collide with is assigned a color. For example, if it hits a gray object, then that gray color ends up on that portion of the "film" or your final image.

Raytracing becomes much more complex when the beam strikes an object that has reflective, transparent, refractive, or other complex optical properties. These properties can cause the ray to be traced further into your scene, where it could end up bouncing from mirrors, dissipating through fog, or bending through a chunk of dense glass. Eventually, a final color is determined for each pixel.

This technique can involve staggering amounts of computation which might make it impractical or impossible to use, but Bryce contains raytracing algorithms optimized for the task of creating natural and supernatural landscapes of all kinds.

RENDERING A SCENE

Once you've selected the rendering options you want to use and chosen a rendering mode, you're ready to start rendering. You render your entire image using the Render controls or use the Plop Render controls to render areas of your image.

USING THE RENDER CONTROLS

The Render controls let you start and resume a rendering of your image. There are controls for enabling two types of fast renders.

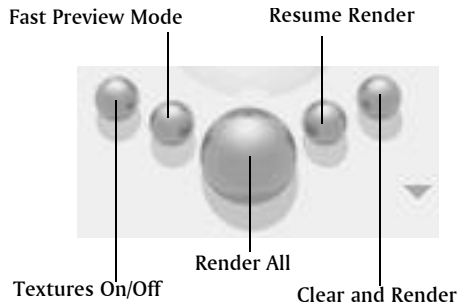

Use the Render controls to control the rendering of your scene.

TO START A RENDERING OF THE ENTIRE SCENE:

- 1 Click the Render All button.
If you have already rendered any portion of your scene, it is cleared before the rendering begins.
You can interrupt any rendering by clicking the mouse.

TO RESUME A RENDERING:

- Click the Resume Render control or press Command/Ctrl+R.

TO CLEAR A SELECTION AND START A RENDERING:

- Click the Clear and Render control or press Command/Ctrl+Option/Alt+R.
This control clears the contents of any marquee'd region, and starts a render of the selected region. Refer to Plop-Render Mode below for more on rendering regions.

Plop-Render Mode

If you've begun rendering your image, you can use the Plop-Render controls to render specific areas of your image. You can use this mode to quickly see the results of repositioning and transformation operations.

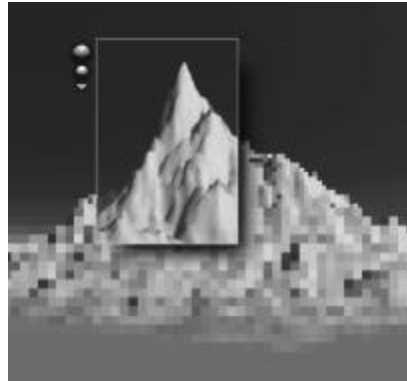

Use Plop-Render mode to render specific areas of your image.

Plop-Render mode is enabled by default, but can be turned off using the Display palette.

TO ENABLE/DISABLE Plop-Render mode:

- Click the Plop-Render On/Off toggle in the Display palette.



When the small rectangle inside the icon (which represents an active Plop-Renderer) is red, Plop-Render mode is on. When it is white, the mode is off.

TO RENDER AN AREA OF YOUR SCENE:

- 1 Make sure Plop-Render mode is enabled.
- 2 Begin rendering your scene by clicking the Render All button in the Render controls.
- 3 Pause rendering by clicking the Render All button again.
- 4 Drag a marquee around an area of your image.
The selection is outlined in a thin white line and is separated from the rest of the image by a drop shadow. A series of buttons appear beside the marquee'd selection.
- 5 Click the top button that appears beside the selection.
You can interrupt the rendering by clicking the mouse.

To RESUME A RENDER:

- Click the second button that appears beside the selection.

To SCALE THE SELECTED AREA TO FILL THE WORKING WINDOW:

- 1 Make sure Plop-Render mode is enabled.
- 2 Begin rendering your scene by clicking the Render All button in the render controls.
- 3 Pause rendering by clicking the Render All button again.
- 4 Drag a marquee around an area of your image. The selection is outlined in a thin white line and is separated from the rest of the image by a drop shadow.
- 5 Click the triangle icon beside the Render controls and choose Zoom to Selection from the menu.

The command centers the selected portion of your wireframe scene and scales it up to fit your window. This is a pan and zoom operation, and therefore does not affect your camera position.

SPRAY RENDERING

You can also paint an area of your scene to render it. Use spray rendering to preview a specific area of your scene. If you render the entire scene after doing a spray render of a specific section, that area will not be re-rendered.

- Spray rendering controls include five circular and five square spray nozzles. While in spray rendering mode, use the 1 through 5 keys to select the circular spray sizes, and the 6 through 0 keys to select the square nozzles.



The Spray Rendering tool.

To RENDER USING Spray RENDERING:

- 1 Click the Spray Rendering tool on the Advanced Display palette.
- 2 Use the tool to paint over the area of your scene that you want to render.
- 3 Adjust the brush size to more easily paint a larger or smaller area.

You can also render a portion of your wireframe or rendered image to quickly see any modifications made to your scene. You can render from Wireframe mode or from Render mode. Spray rendering from Wireframe mode is a preview render that is lost when you press the Escape key.

Spray rendering from Render mode is a true render and can be continued by using Resume Render.

To RENDER FROM WIREFRAME MODE:

- 1 Click the Spray Rendering tool on the Advanced Display palette.
- 2 Use the tool to paint over the area of your scene that you want to render.
- 3 Press the Spray Rendering tool again or press the Escape key to dismiss this render and return to Wireframe mode. This doesn't affect any previous render.

To RENDER FROM RENDER MODE:

- 1 Press the Escape key to switch from Wireframe to Render mode.
- 2 Click the Spray Rendering tool on the Advanced Display palette.
- 3 Use the tool to paint over the area of your scene that you want to render.
- 4 Click the Spray Rendering tool to put the tool away and remain in render mode. Press Escape again to return to Wireframe mode yet not lose your paint rendered area.
- 5 If you Resume Render your scene, Bryce continues to render the un-rendered portions of your scene.

SETTING UP A RENDER

Bryce offers a number of options and controls that let you control rendering.

As you work on a scene, you can use settings that produce fast renders. When you're ready to produce your final image, you can choose settings that produce the highest quality image.

SETTING QUALITY MODE OPTIONS

These options let you control the quality of the rendered image by setting the level of anti-aliasing.

Anti-aliasing removes the jaggies on the edges of objects within the image. In Bryce, anti-aliasing is performed using a super-sampling method. This means that for every pixel that's raytraced, more than one ray is used to determine the pixel's color. The increase in rays increases the quality of the raytraced object.

Anti-aliasing can greatly improve the quality of your image, but it is time-consuming. It can also eliminate some desired roughness from high-frequency textures. anti-aliasing is performed on the last pass of the rendering process.

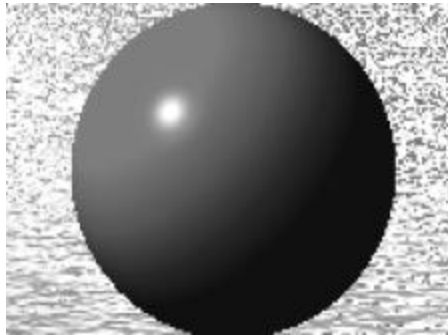

An image rendered without anti-aliasing...

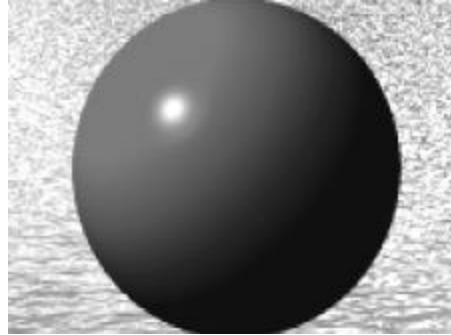

...and the same image rendered using anti-aliasing.

There are four quality modes available in Bryce: Default, Regular, Super, and Premium.

TO SET THE QUALITY MODE:

- Click the triangle icon beside the Render controls, point to Quality, and choose a quality mode from the menu
or
Click the triangle icon beside the Render controls and click Edit Rendering. Click one of the quality modes at the top-left corner of the dialog.

DEFAULT (NO ANTI-ALIASING)

In this mode there is no anti-aliasing performed on the image.

REGULAR (NORMAL ANTI-ALIASING)

In this mode, after the image is rendered, Bryce scans the entire bitmap to determine which areas require anti-aliasing. Only the areas of high concentration are antialiased.

SUPER (FINE ART ANTI-ALIASING)

In this mode, you can control the number of rays Bryce uses to trace every pixel in the image. Higher values produce a higher quality image, but can slow

down the entire rendering process. You should probably only use this mode to render showcase type artwork—not normal working images.

To set the number of rays per pixel numerically:

- 1 Click the triangle icon beside the Render controls and click Edit Rendering.
- 2 Click the Super quality mode. With the Super quality mode selected, the Rays per pixel option becomes available.
- 3 Click the triangle beside Rays per pixel and choose a value from 1 to 256.

PREMIUM (EFFECT ANTI-ALIASING)

In this mode, you can use a variety of premium effects, such as Soft Shadows, Blurry Reflections, Blurry Transmissions, True Ambience, and Depth of Field.

Premium effects include:

- Soft Shadows — Softens the edges of the shadows.
- Blurry Reflections — Blurs reflections.
- Blurry Transmissions — Blurs the transmission of light, for example, when light passes through frosted glass.
- True Ambience — Computes the ambient light for a surface using the color and intensity of nearby surfaces, resulting in color blending from one surface to another.
- Depth of Field — Lets you focus the camera on a particular object, blurring those closer and further away from the camera's focal point. You can control the Lens Radius and Focal Length numerically, or you can have Bryce calculate these values based on a selected object.

To turn on premium effects:

- 1 Click the triangle beside the Render controls.

- 2 Point to Quality and select the Premium quality mode.
- 3 Click the triangle icon beside the Render controls.
- 4 Point to Quality and select a premium effect.

To turn on premium effects and set effect options using the Render Options dialog:

- 1 Click the triangle beside the Render controls and click Edit Rendering.
- 2 Select the Super quality mode.
- 3 Select a premium effect.

For the Depth of Field effect, type a value in the Lens Radius and Focal Length fields or click Set To Current Selection to set the values based on the currently selected object.

DOCUMENT SIZE AND RENDER RESOLUTION

The menu commands at the end of the Render Options menu are quick ways to resize your document. Values shown are expressed in pixels, and are for customizing the size and aspect of your document and the resulting render.

The render resolution options control the resolution of your final image. These options do not affect the resolution of your working document; they affect only the final rendered image.

To choose a document size:

- Click the triangle icon beside the Render controls and choose a document size from the bottom of the menu.

To choose a render resolution:

- Double-click the Render All control, or choose File menu > Document Setup. Click one of the render resolutions at the bottom of the dialog. The selected resolution appears highlighted. Click the OK icon.

SETTING OPTIMIZATION OPTIONS

Bryce 5 includes several new optimization options. These options change the mathematical algorithm used by Bryce to raytrace your image depending on the contents of your scene. There are two types of optimization, BSP and Grid, and each has three levels of optimization to choose from, Minimal, Normal, and Aggressive.

Bryce maintains an internal grid that is comprised of 3D cube increments, 2048 x 2048 x 2048 Bryce units in size. The grid gives you a common reference for all positioning operations within a scene. The grid is also used by Bryce when rendering.

Bryce performs a multitude of mathematical calculations to raytrace a scene. These mathematical calculations use the grid to determine the position of objects in relation to each other. When you create a scene, depending on how objects are distributed in the scene, you may want to specify a different mathematical algorithm to increase the efficiency of the rendering operation.

Bryce uses two different mathematical algorithms for rendering:

- For Clustered Scenes (BSP) — the BSP algorithm is most efficient when rendering scenes that include clustered or overlapping objects.
- For Uniform Scenes (Grid) — The Grid algorithm is most efficient when rendering scenes that contain non-overlapping objects evenly spaced within the Bryce grid.

LEVELS OF OPTIMIZATION

There are three levels of optimization to choose from for each of the above optimization types:

- Minimal — This mode is best used for very simple scenes with less than five objects. In this mode, Bryce predetermines the areas where your objects reside and shoots rays only through that area.

- Normal — This is the best mode for most scenes. In this mode, Bryce determines where your objects reside and then examines the concentration of objects within the larger area. This eliminates the computation of unnecessary rays.
- Aggressive — This is a more extreme version of Minimal mode. It is best used for complex scenes with localized concentrations of objects. If you have imported DXF objects in your scene, this mode will speed up rendering considerably.

TO SET OPTIMIZATION OPTIONS:

- Click the triangle icon next to the Render controls, point to Optimization, and choose an optimization type and level
or
Click the triangle icon next to the Render controls, click Edit Rendering, and choose an optimization type and level from the Render Options dialog.

SETTING POST-PROCESSING OPTIONS

Bryce includes two post-processing options to compensate for the differences between viewing images on a computer display and on paper.

- 48 Bit Dithering — helps you work around the limitations of computer displays. It is a process that allows you to avoid color bands by smoothing. Evening skies or moon rings are good candidates for this option.
- Gamma Correction — allows Bryce to compensate for some of the shortcomings of computer displays. Your images will be brighter and contain colors that are more true to nature.

TO SET POST-PROCESSING OPTIONS:

- 1 Click the triangle icon next to the Render controls and click the desired post-processing options

or

Click the triangle icon next to the Render controls, click Edit Rendering, and click the desired post-processing options from the Render Options dialog.

RENDER REPORTING

This option, when selected, produces a summary report when your image is finished rendering.

The report tells you how long the render took, including the anti-aliasing pass. It also provides statistics on how many rays were shot to create the image and breakdowns for the different types of rays, including a per-pixel breakdown.

To produce a render report:

- Click the triangle icon next to the Render controls and choose Render Reporting from the menu.

or

Click File menu > Document Setup and choose Render Reporting from the menu.

PROJECTION & MASKING

Bryce offers several rendering modes that can be used to create different effects. For example, the Mask Render mode lets you produce an image that can be used as an alpha channel in other graphics applications.

To choose a projection type and mask mode:

- Click the triangle icon next to the Render controls and choose a projection type and mask mode from the menu

or

Click the triangle icon next to the Render controls, click Edit Rendering, and choose a projection type and mask mode from the Render Options dialog.

PROJECTION TYPES

There are two projection types available in Bryce:

- Perspective Projection — renders a fully raytraced color image, based on your current camera's position and view.
- 360° Panorama Projection — produces an image that looks as if your camera has a 360° lens. The left and right edges of the resulting image join seamlessly.

360° Panorama Projection is intended for use with the Bryce 360° scrolling screensaver, or QuickTime™ VR technology. Refer to "QuickTime VR" on page 361 for a description of Apple QuickTime VR.



An example of an image rendered using 360° Panorama projection.

Rendered 360° images will have little resemblance to the wireframe working window behind it; this makes flipping back and forth between wireframe and bit-map modes during composition fairly difficult. For this reason, we recommend working in standard Perspective Render mode as you compose your image.

For a good 360° panoramic image, you need a natural distribution of objects on all sides of the camera.

To prepare a 360° panoramic render:

- 1 While in Perspective Render mode, switch to the Top view using the View controls and position objects around the camera.
- 2 Display the Document Setup dialog using File menu > Document Setup, and either select the Panorama preset aspect ratio, or type in the dimensions that you want.

- 3 Do a quick test render in Perspective Render mode to check composition.
The horizon should be level at the vertical midpoint of your window. If it is not, double-click the Trackball, enter "0" in the Rotate X field and exit the dialog.
- 4 Adjust your camera position and Y/Z rotation.
- 5 Switch to 360° Panorama render mode and render your image.

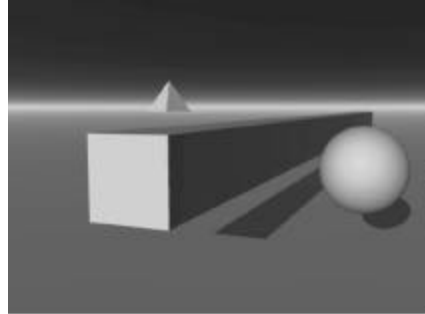

Mask Modes

There are three different kinds of Mask Render modes for rendering available in Bryce, Object Mask, Distance Mask, and Altitude Mask.

OBJECT MASK

In Object Mask mode, Bryce renders any selected objects as antialiased white shapes against a black background. You can use the resulting image as a mask or alpha channel in other 2D image editing programs.



An example of an image rendered as a mask using Object Mask mode.

DISTANCE MASK

This mode results in a grayscale image, with objects represented in shades of gray based upon their distance from the camera. Nearby objects are black, distant objects are white, and objects in-between are progressive shades of gray.

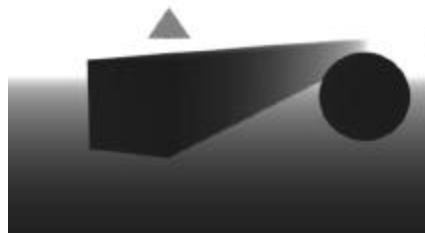

An example of an image rendered using Distance Mask mode.



You can use the Distance Mask image to produce depth-of-field effects using a 2D graphics application.

This mode can be used to create several distance effects. Refer to "Adding Depth" on page 366 for more on using Distance Mask images.

Altitude Mask

This mode results in a grayscale image, with objects represented in shades of gray based upon their height.

You can use Altitude Mask images in the same way you can use Distance Mask images to create special effects in other applications.

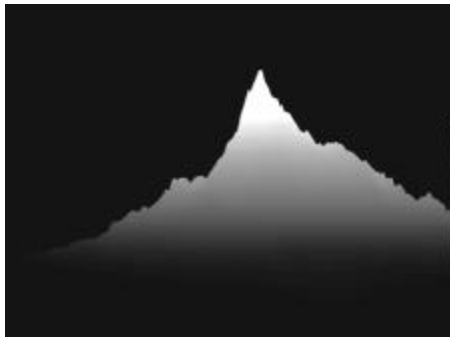

An example of an image rendered using Altitude Mask mode.

SETTING OPTICS OPTIONS

Bryce includes a number of optics options that can help increase the realism of a rendered scene. The optics options include:

- **Reflections** — Lets you choose whether to render reflections in a scene.
- **Transmissions** — Lets you choose whether to render light transmissions in a scene. For transparent objects with a light source behind them, you must render transmissions for light to shine through the objects.
- **Refractions** — Lets you choose whether to render light refractions in a scene. When light is bent by an object such as a prism or a glass of water, you can see distorted views of the environment behind or to the side of the object due to the refraction of light. For Bryce to render these refractions, you must enable this option.
- **Shadows** — Lets you choose whether to render shadows in a scene.

- **Maximum Ray Depth** — Lets you control the depth of rays during rendering. For example, if you place a series of transparent objects one in front of the other, the Maximum Ray Depth setting determines how many of these objects the light will pass through.
- **Total Internal Reflection (TIR)** — Lets you control the amount of TIR in a scene. When you have reflective objects such as prisms or mirrors in a scene, you can encounter situations where light rays bounce back and forth an infinite number of times within the object or between two objects. By limiting the TIR depth, you can produce realistic scenes that include a certain amount of TIR. This lets you avoid creating an infinite number of internal reflections, thus speeding up the rendering time.

TO ENABLE OPTICS OPTIONS:

- 1 Click the triangle icon next to the Render controls and click Edit Rendering.
- 2 Click an optics option to enable or disable it. When a checkmark appears beside the option, the option is enabled. When there is no checkmark, the option is off.
- 3 Type a value in the Maximum Ray Depth field.
- 4 If you have enabled the Total Internal Reflection (TIR) option, type a value in the Maximum TIR Depth field.

PREVIEW RENDER MODES

Preview Render modes are accessed using the Render controls or the Render Options dialog, and provide lower quality renders that you can use to preview your image.

FAST PREVIEW

When this mode is enabled, the renderer ignores areas of low frequency and only raytraces areas of high frequency. This results in accelerated renders that are great for previewing during a session.

However, it also results in some patchiness in certain mid-frequency areas, so it should not be used for final output.

To enable FAST PREVIEW mode:

- 1 Click the Fast Preview button in the Render controls. When the button turns blue, the mode is enabled. When the button is silver, the mode is off.
or
Click the triangle beside the Render controls, click Edit Rendering. Select the Preview Render option to enable Fast Preview mode, and select the Full Render option to disable it.

TEXTURES ON/OFF

When this mode is enabled, all textural parameters are disabled. This mode performs the following procedures to speed up a render:

- Objects with properties like transparency, reflection, and bumpy textures are rendered in flat opaque shades.
- Fog, Haze and Clouds are disabled.
- Any item with a procedural texture is rendered with a color drawn from the ambient color channel in the Materials Composer.
- Any item with a simple color texture is rendered in that color.

The Textures On/Off mode is available in any mode.

To enable TEXTURES ON/OFF mode:

- 1 Click the Textures On/Off button in the Render controls. When the button turns blue, the mode is enabled. When the button is silver, the mode is off.
or
- 2 Click the triangle beside the Render Controls, click Edit Rendering, and click Render With Textures. When a checkmark appears beside the option, the mode is enabled. When there is no checkmark, the mode is off.

RENDERING ANIMATIONS

Rendering an animation is a lot like rendering a still image. Each frame in the animation is processed exactly like a still image. You can use the same rendering options you use to render still images.

In addition to the standard still image rendering options, there are several options you can set for movie files: you can choose a file type, a compression option, and a range of frames to render. You set movie rendering options using the Render Animation dialog.

THE RENDER ANIMATION dialog

The Render Animation dialog contains all the options you'll need to render your scene as a movie. In this dialog, you select the range to render, the file format for the resulting animation, the quality of the animation, the filename and location for the animation, and the network rendering options.

RANGE TO RENDER

When you render an animation, you can render the entire animation, a specific range of frames, or only the frames within the Working Area of your animation's timeline. Refer to "Setting Up the Working Area" on page 325 for more on the Working Area.

Output Module

The Output Module section of the Render Animation dialog lets you choose a format and level of compression for the animation.

- On the Macintosh, you can render a scene as a QuickTime (MOV) file, or as sequenced frame files.
- On the PC you can render your scene as a MOV, AVI file, or as sequenced frame files.

The Edit button lets you access all the available compressors. The items listed in the Video Compression dialog depend on the compressors you have on your system. Refer to the documentation that came with the compressor or your system software for instructions on using a specific compressor.

FILE LOCATION

The File Location area of the Render Animation dialog lets you specify a destination and a filename for the animation.

RENDER ON NETWORK

The Render on Network option lets you render your animation on multiple computers connected by a TCP/IP network. Refer to “Network Rendering” below for more on rendering over a network.

TO START THE RENDERING OF AN ANIMATION:

- 1 Choose File>Render Animation.
or
Press Alt+Shift+R. The Render Animation dialog appears.
- 2 Choose a Range to Render option or specify a start and end frame number for the range.
- 3 Click the triangle beside Output Module and choose a file format for the animation.
- 4 Click Edit and choose the compression options for the animation.
- 5 In the File Location area, click Set and enter a destination and name for the animation.
- 6 If you want to perform a network render, enable the Render on Network option and click Configure to set up the network render. Refer to “Network Rendering” below for more on setting up a network render.
- 7 Click the OK icon. Bryce starts rendering each frame in the animation.

NETWORK RENDERING

Rendering complex scenes and animations requires a significant amount of computational power.

Using only one computer, a complex scene or animation can take many hours to render. You can take a number of steps to decrease the time required to render such a scene, such as reducing the complexity of the scene, reducing the quality of the render, or upgrading the computing power of the computer.

The new Network Rendering feature in Bryce 5 lets you spread a rendering job over multiple computers. This lets you reduce the amount of time required to render a complex scene without sacrificing the complexity of the scene or the quality of the final rendered image or animation.

This is accomplished by breaking a scene into smaller sections and sending each section to a separate computer to be rendered simultaneously. The more computers you have working on rendering a particular scene, the less time it takes to render the scene.

HOW NETWORK RENDERING WORKS

To use network rendering, you need two or more computers connected by a TCP/IP network. One of the machines acts as a server that controls the other machines, sending them sections to be rendered and reassembling all of the rendered sections into the final image or animation. The other machines act as client machines, receiving and rendering their sections of the image, and then sending the rendered section back to the server.

When you render an animation over a network, by default, Bryce sends each frame of the animation to the client computers.

When you render a single frame over a network with the Tile Optimization option turned on, Bryce divides the frame into tiles and sends the tiles to the client computers.

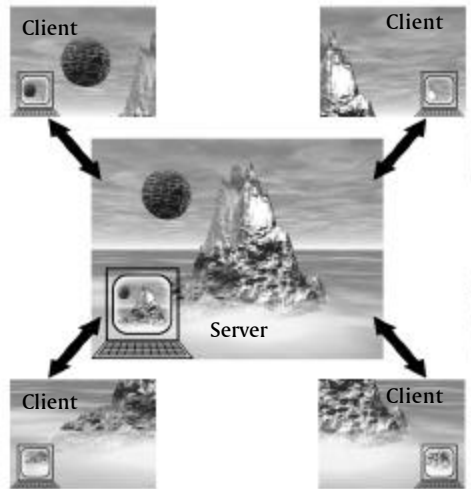

The Tile Optimization option divides a frame into tiles, sending each tile to a client computer for faster rendering of the frame.

The server is the only computer that needs to have Bryce installed; the other computers can have either a licensed copy of Bryce installed, or you can install Bryce Lightning, an application included with Bryce that is specifically designed for network rendering.

To start a network rendering session, you will need to know the IP addresses of each of the client machines you want to use. When you launch Bryce Lightning, it will display that information for you.

The next step is to open a scene on the server and select the network rendering option. You will then need to configure the server by giving it the IP addresses of the client computers you will be using for rendering the scene.

PREPARING FOR NETWORK RENDERING

TO INSTALL BRYCE® LIGHTNING ON A WINDOWS CLIENT:

- 1 Insert the Bryce CD-ROM into the CD-ROM drive on the client computer.

- 2 Click Start on the Windows taskbar, and click Run. Type X:\Bryce Lightning\setup where X is the letter that corresponds to the CD-ROM drive.
- 3 Follow the instructions on your screen.

TO INSTALL BRYCE LIGHTNING ON A MACINTOSH CLIENT:

- 1 Insert the Bryce CD-ROM into the CD-ROM drive on the client computer.
- 2 Navigate to the Bryce Lightning folder on the CD-ROM.
- 3 Double-click the Bryce Lightning installer to start the installation.
- 4 Follow the instructions on your screen.

TO UNINSTALL BRYCE LIGHTNING:

- 1 Drag the Bryce Lightning folder to the Trash/Recycle Bin.

TO DETERMINE THE IP ADDRESS OF A CLIENT COMPUTER USING BRYCE LIGHTNING:

- Launch Bryce Lightning on the client computer.
Bryce Lightning displays a dialog listing the IP address of the client computer it is running on.

TO CONFIGURE THE SERVER COMPUTER FOR NETWORK RENDERING:

- 1 Launch Bryce Lightning on the client computers you plan on using for the network render.
- 2 Launch Bryce on the server computer.
- 3 Open the scene you want to render.
- 4 Click File>Render Animation.
- 5 Click Render on Network.
- 6 Click Configure.

The Network Render Settings dialog opens. You can use the Network Render Settings dialog to add and remove computers from the

list of available clients, assign a name to the rendering job, and choose settings.

- 7 In the Render Job field, type a name for the rendering job.
- 8 In the Client IP Address field, type the IP address of a client computer and click Add.

Newly added client computers in the Client List are selected by default (they will have a checkmark beside them). You can click beside individual client computers in the Client List to select or deselect them for network rendering, or click the Select All button to select or deselect all the client computers in the Client List at once.

- 9 Choose the desired options:
 - Save Client List — lets you save the Client List so that the next time you use network rendering to render a scene, the client computers will already be entered in the Client List.
 - Use Host to Render — lets you use the server computer as well as the client computers to render the job.
 - Tile Optimization — tells Bryce to optimize how sections of the scene are sent to the client computers.

By default, Bryce divides the scene by frames and sends each client computer one frame at a time for rendering. While this works well for large animations, a single-frame scene is sent to a single machine for rendering, even if there are many computers in the Client List. With Tile Optimization turned on, Bryce breaks each frame of an animation or single-frame scene into multiple tiles and sends these tiles to the client computers for rendering, improving the efficiency of the network render.

To remove clients from the Client List:

- 1 In the Network Render Settings dialog, select the client to be removed from the Client List.
- 2 Click Disconnect.

To start the network render:

- 1 Click the OK icon in the Network Render Settings dialog to return to the Render Animation dialog.
- 2 Click the OK icon in the Render Animation dialog. The network rendering job will start.

MONITORING NETWORK RENDERING

The Network Render Manager lets you monitor the progress of the network render. You can also monitor the status of individual client computers; pause rendering on a client computer; cancel rendering on a client computer; and add or remove client computers from the list of available clients. You will not see the scene being rendered on the server. However, you can go to the client computers and see the section that client is rendering.

The Network Render Manager displays a list of all network rendering jobs in progress, the state of each job, and its percentage complete. You can use the Network Render Manager to change the settings of a network rendering job.

To monitor a render using the Network Render Manager:

- 1 Click File>Network Render Manager.

From the Network Render Manager, you can monitor the progress of your network rendering jobs, view the status of the client computers working on a job, and pause or cancel a job.

To pause a network rendering job:

- 1 Click File>Network Render Manager.
- 2 Select the job to be paused.

- 3 Click Pause.

To RESUME A NETWORK RENDERING job:

- 1 Click File>Network Render Manager.
- 2 Select the paused job.
- 3 Click Run.

To CANCEL A NETWORK RENDERING job:

- 1 Click File>Network Render Manager.
- 2 Select the job to be cancelled.
- 3 Click Cancel .

To VIEW THE STATUS OF THE CLIENT COMPUTERS WORKING ON A job:

- 1 Click File>Network Render Manager.
- 2 Select the network rendering job.
- 3 Click Settings. This brings you to the Network Render Settings dialog. Bryce will automatically verify the current status of client computers in the Client List, except for those clients you have manually disconnected.

You can click the Update button to have Bryce verify the current status of the client computers in the Client List that are listed as unverified, unreachable, or disabled.

The Status column in the Client List displays colored icons next to each client computer. Each color represents a different status:

- Green=Ready
The client computer at that IP address is running Bryce Lightning and is available to receive a rendering job from the server.
- Orange=Working
The client computer at that IP address is running Bryce Lightning and is processing a rendering job.
- Red with horizontal bar=Locked
The client computer at that IP address is connected to another server, or an error has occurred on the client computer.

- Red with lightning bolt=Unreachable
The client computer at that IP address is unreachable or is not running Bryce Lightning, the IP address is invalid, or the client computer does not have enough memory to render the job.
- Black with question mark=Unverified
The Network Render Manager did not attempt to determine the status of the client computer at this IP address. This icon will only appear when you first add a client to the Client List.
- Grey=Disabled
The client computer at that IP address has been disconnected by the user and will not be used for the rendering job.

BATCH RENDERING

Batch Rendering lets you render a number of files at the same time. This way, instead of rendering each scene as you create it, you can set up a number of scenes, save them and then render them all at once at a convenient time.

To PERFORM A BATCH RENDER:

- 1 Save a number of scenes to a folder.
- 2 Drag all the files to the Bryce application.
Bryce opens each file, renders it, saves it, and then opens and renders the next file. You can render any number of files this way.

FAST RENDER STRATEGIES

There are several techniques you can use to speed up the rendering process. These techniques are most useful when rendering animations, where you may have a large number of images to render.

You can greatly increase the speed of a render just by using the Preview Render modes. Below is a table showing the percentage of time it takes to a render a scene, containing complex materials and lights, using normal and preview modes.

Render Option	% of standard time
Normal Render	100%
Fast Render	41.7%
Textures Off	35.4%
Fast Render w/ Textures Off	8.3%
Fast, Textures Off, anti-aliasing Off	2.1%

PATCH RENDERING

Using the Plop-Render mode, you can do a patch render of image. Patch rendering involves the rendering of background and flat elements using normal rendering and then using the Plop-Render controls to render areas that contain more complex elements.

There are two things you should remember when using patch rendering:

- Make sure you use the Clear and Render button when you make changes to a partially rendered image. If you stop a rendering, make changes and then click Resume Render, you'll end up with noise instead of an image.
- If you change elements that don't affect a large area of your scene, you don't have to render the entire scene again. For example, if you render a scene with a floating sphere and then delete the sphere, you don't need to re-render the scene, only the area where the sphere was.

To PATCH RENDER YOUR IMAGE:

- 1 Start a render as normal.
- 2 Let the rendering proceed for two or three passes and then click the mouse.
- 3 Switch to Bitmap display mode.

- 4 Drag a marquee around key portions of your scene and then render those areas using the Plop-Render controls.

YOU CAN ALSO SPEED UP RENDERING USING THESE TECHNIQUES:

- Limit the number of lights.
- Keep background objects simple.
- Limit the number of volume materials you apply.
- Limit the number of transparent and reflective objects.
- Limit the number of frames per second to 15 for QuickTime movies.
- Divide animations into smaller files and eliminate objects that won't be seen in the rendered frames.
- Turn off anti-aliasing when previewing animations.

WORKING WITH RENDERED IMAGES

Once your scene is rendered, it becomes a 2D image that you can save in various formats and edit in 2D image applications.

In Bryce, the 2D image is used as the Bitmap display mode. You can use the bitmap as a guide for moving objects, or as a preview of your final image.

SCALING YOUR IMAGE

The Pan and Zoom tools work independently in wireframe display mode and in bitmap display mode. So if you use the Zoom tool to scale your wireframe scene, your rendered image remains unchanged.

You can use the same tools and commands to zoom closer or further from your rendered image, independent of the scale of your wireframe scene. If you zoom in sufficiently, you can use the Pan tool to pan through the enlarged image.

Refer to “Panning” on page23 and “Zooming In and Out” on page22 for more on the Pan and Zoom tools.



15

ANIMATING

Animation is the process of adding a fourth dimension to your scene—time. To create an animation, you arrange a scene then record your movements or transformations of objects over time. Bryce creates a motion path from your recorded movements and then generates an animation.

You can animate almost anything in your scene:

- the motion of objects and the camera
- object size and shape
- object materials
- terrain objects
- sky properties

THE ANIMATION PROCESS

Animation is a cooperative process between you and Bryce. You arrange objects and choose scene settings, and then make adjustments to the objects and scene over time. Bryce fills in the gaps between adjustments. When you play the animation, the illusion of motion is created.

The steps to creating an animation are as follows:

- Create objects using the Create tools.
- Build a scene by arranging and transforming objects, lights, and the camera.
- Adjust the position, orientation, or scale of objects. Each time you make an adjustment, you create a *key event* which indicates a point where an object property was changed.
- Adjust the shape or placement of the motion path.
- Adjust the speed at which the object moves along the motion path using the Advanced Motion Lab.
- Render the animation as a movie file. You can render the animation as a QuickTime/AVI movie file or as a set of frames.

TIME-BASED ANIMATION

In Bryce, key events are tied to real-world time increments (minutes and seconds) rather than individual animation frames. This means that you can create key events at specific points in time without worrying about the number of frames in your final animation.

Bryce automatically creates all the frames necessary to move from one key event to another. If you change the frame rate, Bryce adjusts the number of the frames between key events to match the new frame rate.

For example, let's say your frame rate is set to 15 fps (frames per second) and then you set up two key events, one at 1 second and the other at 2

seconds. Bryce automatically fills in the 15 frames necessary to move from the key event at 1 second to the key event at 2 seconds. If you change the frame rate to 30 fps, Bryce will add another 15 frames between the two key events to match the new framerate.

ANIMATION AND MOTION PATHS

As you change the position, of an object, Bryce creates a motion path which shows you the path the object will take as it moves from one key event to another.

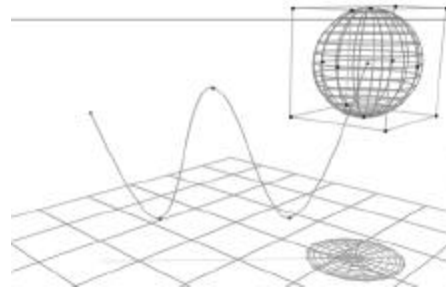

An object's motion path shows you the trajectory of the object as it moves from one key event to another.

You can edit an object's motion path to adjust its trajectory throughout the course of the animation.

Refer to "Editing Motion Paths" on page 331 for more on motion paths.

ANIMATABLE PROPERTIES

Each characteristic of an object or effect that can be animated is called a property. Most objects have many animatable properties. Properties like position, size and orientation are common to all objects. Other properties are specific to certain types of objects.

Lights have special properties like brightness, falloff and gels.

Skies have their own set of properties that control everything from cloud coverage to the time of day.

The properties of individual objects can change depending on the material you apply. The color, texture, and density of an object can also be animated.

Some properties can be animated directly in a specific editor. Object material properties can be animated from within the Materials Lab and terrain geometries can be edited from within the Terrain Editor.

PROPERTIES IN THE SEQUENCER

Every time you change an object's property, it appears as a key event in the animation's Sequencer. In the Sequencer, each property of an object can be viewed on a separate timeline. You can expand an object's listing to see all the transformations or changes that have been applied to its properties. If you have not performed any transformations on the object, it cannot be expanded.

Refer to "Editing Property Timelines in the Sequencer" on page 335 for a complete discussion of the Sequencer.

TO EXPAND A LISTING IN THE SEQUENCER:

- 1 Make sure the Advanced Motion Lab is visible. If it's not, choose Objects menu > Advanced Motion Lab.
- 2 Click the object's listing.

CREATING ANIMATIONS

The Animation controls are the tools you'll use most often when creating animations. The palette provides tools for most of the basic animation functions:

- viewing the timeline
- moving the current time
- setting the length of the animation
- specifying the Working Area
- previewing the animation

- recording key events
- adding/deleting key frames

The Animation controls appear at the bottom of the Working window as well as in the Terrain Editor and the MaterialsLab.

The Animation controls are made up of three areas:

The Timeline, located at the top of the palette, displays a visual representation of the time in your animation. The indicator on the timeline (called the *Current Time Indicator*) represents the current time.

The Animation Preview Controls, located below the Timeline, let you preview your animation in the Working window.

The Key Frame Controls, located at the right edge of the palette, let you add and delete key frames.

TO DISPLAY THE ANIMATION CONTROLS IN THE WORKING WINDOW:

- By default the Animation controls are located at the bottom of the Working window. If the Selection palette appears at the bottom of the window, click the Time/Selection Palette toggle in the bottom-right corner of the Bryce window (or press S).



Use the Time/Selection Palette toggle to switch between the Animation controls and the Selection palette.

The button switches between the Selection palette and the Animation controls.

SETTING UP AN ANIMATION

Before you start setting up key frames or adjusting the timeline, you should set up some general parameters for your animation.

The Animation Setup dialog lets you set up the duration, the frame rate and whether you want to display animation time as SMPTE (i.e.; hours:minutes:seconds:frames) or frame numbers.

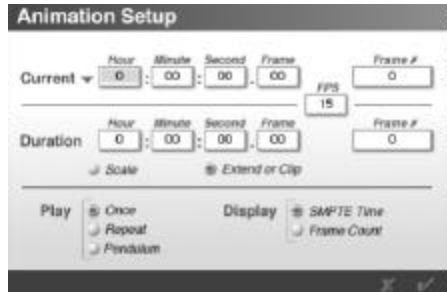

The Animation Setup dialog can be used to set the duration of your animation or to move to a specific point in the timeline.

TO SET THE DURATION OF YOUR ANIMATION NUMERICALLY:

- 1 Choose File menu > Animation Setup or double-click the Current Time Indicator. The Animation Setup dialog appears.
- 2 Click the Scale button. This switches the Duration fields to set the duration of your animation.
- 3 In the Duration fields, enter the total length of your animation in hours, minutes, seconds and frames.

When you enter a duration, Bryce automatically calculates the number of frames in the animation, based on the current frame rate. The number of frames is displayed in the Frame# field.

SETTING THE FRAME RATE

The Frame rate for your animation can have a large impact on the final quality of your rendered movie. A low frame rate, is faster to render but may produce motion which is more jumpy, while a higher frame rate produces much smoother motion.

Bryce displays frames as frames per second (fps). 15 fps is usually good enough for motions displayed on a computer. 30 fps is standard for broadcast-quality video.

TO SET THE FRAME RATE FOR YOUR ANIMATION:

- 1 Choose File menu > Animation Setup or double-click the Current Time Indicator. The Animation Setup dialog appears.
- 2 Enter a frame rate in the FPS field.

ANIMATION TOOLS

Bryce 3D's animation tools are designed to help you animate the properties of your scene.

ANIMATION CONTROLS

The animation controls let you record an animation and preview it in the Working window. You can also use the controls to change the current time or move to different points in time.

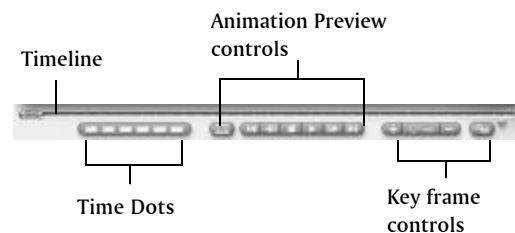

Use the animation controls to record and preview your animation.

The Timeline appears in four places in Bryce: the Working window, the Terrain Editor, the Sky Lab, and the Materials Lab.

All four timelines represent the same time. The only difference is that when you're in an editor, you can only add frames for properties associated with the editor. For example, in the Terrain Editor you can only add key frames associated with terrain properties.

When you preview a timeline in the Working window, you'll be able to see all the changes in your scene, including any changes you may have made in other editors or in the Advanced Motion Lab.

THE TIMELINE

The Timeline is a graphical representation of time. The darker gray area within the Timeline represents the current length of your animation.

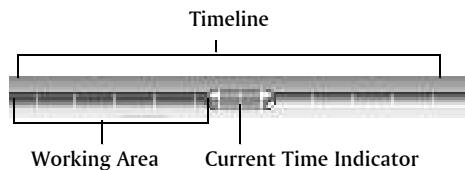

The Timeline indicates the length of your animation and the current time.

The blue colored section of the timeline represents the length of the Working Area. The Working Area can be used as a visual guide to help you isolate portions of your timeline. When you render the animation you can choose to render the entire timeline or just the Working Area. When you use the animation preview controls, only the Working Area is previewed. Refer to “Setting Up the Working Area” on page 325 for more on the Working Area.

The Current Time indicator lets you move to different points in time. This is the main tool you'll use to create animations. Every time you want to add a key event, you move the Current Time indicator to a different point on the timeline.

WORKING WITH TIME

The light gray area in the Timeline is called the Available Time Area and it represents all time. This area is unlimited; you can scroll the time area infinitely.

The white tick marks within the Timeline are visual cues that let you know when the time area is moving. If you move the Current Time Indicator off the screen, you'll see these white ticks move along the time area.

TO SCROLL THE TIME AREA:

- Drag the Current Time Indicator off the screen to the right.

You'll see the white tick marks move along the time area to the left.

SETTING THE ANIMATION RANGE IN THE TIMELINE

The dark gray within the light gray area of the Timeline represents the total length of your animation. This area is usually hidden by the Working Area, so you may need to shorten the Working Area to adjust the Animation Range.

This area is automatically generated as you set up key events. The time of the final key event automatically creates the limit of the animation range. However, you can manually extend or shorten the area to set the range of your animation.

You cannot shorten the Animation Range below the last frame in the scene since you can't have frames outside the animation range.

TO MANUALLY SET THE ANIMATION RANGE:

- In the timeline, drag the handle that appears at the end of the Animation range to the point where you want the animation to end.
The handle may be obscured by the Current Time Indicator, so you might have to move the indicator to a different position.

SETTING THE CURRENT TIME FOR AN ANIMATION

The large green handle in the Timeline is called the Current Time Indicator (commonly called a scrubber). It sets the current time of the animation.

The Current Time Indicator is the most important tool of the Animation controls. When you're creating key events, the Current Time Indicator controls when the key event occurs in the animation.

Refer to “Recording Key Events” on page 326 for complete instruction on creating key events.

As you move the Current Time Indicator the Text Display Area shows you the current time. If you're using SMPTE time, the current time is displayed as:

00:00:02.13
Hours Minutes Seconds Frame #

The Frame # changes as you change the frame rate for the animation. For example, at 15 fps Bryce will insert 15 frames within each second.

If you're using Frame number, the number of the current frame is displayed.

You can also move to a specific point in time using the Animation Setup dialog. In this dialog, you can move to either a specific time or frame.

To move to a specific frame manually:

- Drag the Current Time Indicator along the Timeline.
As you drag, watch the Text Display Area. You'll notice that the final number cycles through each frame in the second of animation time. So at 15 fps the final number will cycle through frame 0-14 between seconds.
Release the mouse button when the Frame # reaches the desired frame.

The Current Time Indicator also controls which portion of your animation is being displayed in the Working window.

When the indicator is at the beginning of the animation, you're seeing the first frame of the animation in the Working window. When you move the indicator, the Working window displays a different portion of the animation. So, when you move the indicator to the center of your animation range, you're seeing what the animation looks like at the middle of the movie.

To move the current time manually:

- Drag the Current Time Indicator along the Timeline. Release the mouse button when the Text Display Area shows the desired time.

To move the current time numerically:

- 1 Choose File menu > Animation Setup. The Animation Setup dialog appears.
- 2 In the Current fields, enter the hour, minutes, seconds and frame you want to move to.
The Frame # field displays the number of the frame located at the specified time.

Time Dots

The Time Dots let you save positions on the timeline. You can use the dots to quickly jump between areas of the timeline you're working on.



Use the Time dots to quickly move between saved positions along the timeline.

To save the position of the Current Time Indicator:

- 1 Move the Current Time Indicator to the position you want to save.
- 2 Click on an empty Time Dot at the bottom of the Animation controls.
A dot is empty when it appears white.

To move the Current Time Indicator to a saved position:

- Click the Time Dot for the position you want to use.

To delete a saved position:

- Option/Alt + click on a full Time Dot.
A full dot appears blue.

SETTING UP THE WORKING AREA

The blue portion of the Timeline represents the Working Area. This area highlights the portion of the timeline you're currently working on.



Use the Working Area to isolate the portion of the timeline you're currently working on.

When you're previewing your animation, only the portion of the timeline within the Working Area is previewed.

The Working Area is most useful when you're working on a long animations as it saves on preview time, or when you're refining a specific portion of your animation.

When you're rendering the animation, you can choose to render the entire animation, or just the Working Area portion.

You can also use the Working Area to render out sections of the timeline while you're setting up the animation, and then render the entire Animation Range when you're creating the final animation.

TO SET THE RANGE OF THE WORKING AREA MANUALLY:

- Drag either end of the existing Working Area. Release the mouse button when the Working Area is the desired length.

The Working Area cannot be extended past the end of the Animation Range.

TO SET THE RANGE OF THE WORKING AREA NUMERICALLY:

- 1 Choose File menu > Animation Setup or double-click the Current Time Indicator. The Animation Setup dialog appears.
- 2 Click the triangle icon at the top-left of the dialog and choose Working Range Low from the menu.
- 3 Enter the starting time for the Working Range.

- 4 Click the triangle icon again and choose Working Range High.
- 5 Enter the ending time for the Working Range.

SETTING TIMELINE SCALE

The scale indicator at the right edge of the timeline let you adjust the scale the timeline.

If you have a very long timeline, you can use this control to scale it down so you can see the whole timeline at once. If you have a very short timeline, you can use the control to scale it up so it extends across the length of the palette.



Use the scale indicator to scale the timeline.

TO SET THE SCALE OF THE TIMELINE:

- Drag the scale indicator.
Drag right to increase the scale and left to decrease it.

The scale of the timeline does not affect its length, only how it's displayed in the Animation controls.

SCALING ANIMATION DURATION

You can adjust the length of your animation, by scaling its duration to fit within a certain amount of time. For example, you created an animation that's five seconds long, but only want it to take up three seconds, you can scale the entire animation to last only three seconds.

When you scale the animation, all the events in the animation are compressed or stretched to fit within the desired amount of time. If you increase the scale, the events are stretched out, so they take longer to complete. If you decrease the scale, the events are compressed so the action speeds up.

TO SET THE SCALE OF THE ENTIRE ANIMATION MANUALLY:

- Hold down Option/Alt and drag the animation range handle. Release the mouse button when

the duration of the animation is the desired length.



Option/Alt-drag the animation range handle to scale the animation down or up.

To SCALE THE ANIMATION NUMERICALLY:

- 1 Choose File menu > Animation Setup or double-click the Current Time Indicator. The Animation Setup dialog appears.
- 2 Click the Scale Animation button.
- 3 Enter the desired animation duration in the Duration fields.

RECORDING KEY EVENTS

You can record key events by enabling Auto-Record mode. The Timeline options menu, located at the right edge of the controls, lets you enable or disable Bryce's automatic animation system.

When you enable Auto-Record mode, every object transformation or change of property you perform is recorded as a key event.

A key event can store any change in size, position, orientation, material property, sky property, light property or geometry.

However, a key event can only store one change per property at a specific point in time for each object in the scene. This means that at a single point in time, you can only have one change in position, size, material, or geometry per object recorded as a key event.

If you keep changing the same properties at the same point in time, the new changes replace existing changes. Only the last change you perform is recorded as the key event.

To record more than one change in the same object's property you have to move to a different point in time. Then each change can be recorded as a separate key event and applied to the animation.

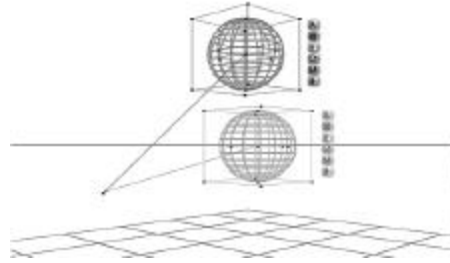

If you move an object up and down at the same point in time, only the last transformation is recorded as the key event.

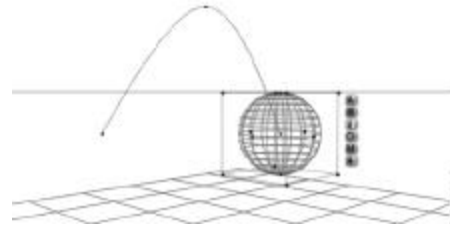

...but if you move the object up at one point in time and then move the object down at a different point in time, both transformations are recorded.

When Auto-Record mode is disabled, the animation system is off. This means that your changes are not recorded as key events, and changes in the Timeline do not effect your view in the Working window.

You can continue changing object and scene properties, but they won't be recorded as key events. If you want to record a setting or transformation you'll have to manually add a key frame using the Add Frame button. Refer to "Adding and Deleting Key Frames" on page 328 for more on adding frames.

To ENABLE OR DISABLE AUTO-RECORD MODE:

- Click the triangle icon to the right of the controls and choose Auto-Key. The animation system is on when the option has a checkmark next to it.

Choose Auto-Key again to turn off the animation system.

ANIMATION PREVIEW CONTROLS

The Animation Preview controls let you move between the key frames in your animation.

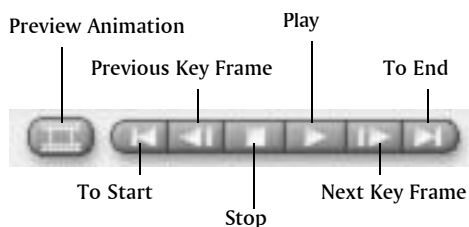

Use the Animation Preview Controls to move between key frames in your animation and start the movie preview.

The outermost buttons move to the beginning and the end of the animation. The inner buttons move to the next and previous key frames, and start or stop the preview.

PREVIEWING ANIMATIONS

You can preview your animations using either the mini-preview in the nano-preview or by using the Animation Preview controls. Both of these methods allow you to see either a rendered preview or a storyboard.

USING THE MOVIE PREVIEW WINDOW

Using the movie preview window, you can see a rendered version of your animation quickly.

TO PREVIEW YOUR ANIMATION:

- 1 Create an animation.
- 2 Click the Preview Animation button.

USING THE STORYBOARD PREVIEW

Using the storyboard preview feature, you can review or navigate your animation, frame-by-frame.

TO VIEW YOUR STORYBOARD:

- 1 Create an animation.

- 2 Click and hold down on the Preview Animation button.
- 3 Select Storyboard.
- 4 Click on the Preview Animation button.

All of the frames appear in a grid pattern as they are rendered. When the rendering is finished, the movie plays in the nano-preview.

TO STOP THE MOVIE PREVIEW:

- You can stop the preview at any time by clicking the mouse.

TO EXIT MOVIE PREVIEW MODE:

- To exit movie preview mode completely, press the Esc key or redraw/render your scene.

ADDITIONAL FEATURES OF THE STORYBOARD







If you pause in the storyboard portion of the animation preview, you can perform various manipulations on your animation. You can:

- Click on a frame to select it.
- Set the current time to that frame.
- Drag the scrubber and move forward or backwards through the animation.
- Double-click the corresponding storyboard image to render any of the frames.

As you perform these manipulations, the animation updates in real-time in the movie preview window.

USING THE ANIMATION CONTROLS

When you play an animation, all the frames in the animation within the Working Area are displayed. The preview is shown in Wireframe display mode.

-  Plays the animation. Click during play to pause the animation.
-  Stops the animation.
-  Moves to the beginning of the Recorded Area.
-  Moves to the end of the Recorded Area.
-  Moves one key frame forward in the animation.
+ Shift moves one frame forward.
-  Moves one key frame backward in the animation.
+ Shift moves one frame back.
-  Starts a quick animation preview.

SETTING PREVIEWING OPTIONS

There are three options you can use to alter the preview of your animation. You can preview the animation only once. You can play the animation continuously, or you cycle forward through the animation, and then back.

TO SET A PREVIEW OPTION:

- 1 Choose File menu > Animation Setup. The Animation Setup dialog appears.
- 2 Enable a Play option:
 - Once plays the animation only once.
 - Repeat plays the animation continuously.
 - Pendulum plays the animation forwards then backwards, then forwards, continuously.

KEY FRAME CONTROLS

The Key Frame controls let you add and delete key frames in your animation.

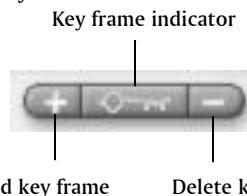

Use the Key Frame controls to add and delete key frames from the timeline.

The Key frame indicator is only active when the current time is at a key frame.

ADDING AND DELETING KEY FRAMES

Usually you use the Auto-Record mode to add key frames to your animation, but there are some cases when you would need to force the system to create a key frame. For instance, if you accidentally make a number of changes while Auto-Record mode is disabled, you'll have to create a key frame to store your changes, or they'll be discarded when you move to a different point in time.

ADDING KEY FRAMES

The Add key frame (plus) button lets you add a key frame. When you are in Camera View, with nothing selected, Add key frame automatically key frames the camera. In Director's view, it does not. It also keys the sky.

In Auto-Key mode, Bryce automatically adds key frames for you, but when you disable the mode, you'll have to use Add Key frame to add key frames at points in the timeline.

If you have an object selected, Bryce only records the changes in property for the selected object. If you have nothing selected, Bryce only records the changes in the sky (i.e. changes you make in the Sky & Fog palette).

You can also modify the add key frame operation so that, for a selected object, only a specific property is recorded as a key event.

To add a key frame:

- 1 Move the Current Time Indicator to the point where you want to add a key frame
or
If you need to force Bryce to overwrite an existing key frame, leave the Current Time Indicator where it is.
- 2 Click the Add Key Frame button.
Any changes you made at this point are recorded in the key frame.

To add a frame for a certain property:

- 1 Select an object.
- 2 Hold down the mouse button over the Add Key frame button and choose an object property from the menu that appears.

To add a key frame for sky properties:

- Make sure there is nothing selected, and click the Add Key frame button.
or
- Hold down the mouse button over the Add Key frame button and choose Sky from the menu.

DELETING KEY FRAMES

The Delete Key frame button deletes the current key frame event or a specific type of key event. In the Working window, deleting a key event deletes all the frames at the current time. In the editors the Delete Key frame button only deletes key events for the properties associated with the editor.

As with adding frames, Bryce deletes frames differently based on your current selection.

If you have an object selected, Bryce only deletes the changes in property for the selected object. If you have nothing selected, Bryce deletes the changes recorded for your scene's sky.

You can modify the Delete Key Frame button's function so that only a certain type of object property is deleted.

Adding or deleting frames will effect the shape of an object's motion path.

To delete a key frame:

- 1 Use the Animation Preview controls to move through the key frames until you find the frame you want to delete.
- 2 Click the Delete Key Frame button.
All the properties recorded at that point in time are deleted.

To delete a frame for a specific object property:

- 1 Select an object.
- 2 Hold down the mouse button over the Delete Key Frame button and choose the object property from the menu that appears.

ADDING AND DELETING FRAMES IN THE EDITORS

When you add a frame in the editors, only the properties associated with the editor are recorded as a key frame.

When you delete a frame in the editors only the properties associated with the editor are deleted. For example, if you delete a frame that contains position, material and scale data in the Materials Lab, only the material data is removed from the key frame.

ANIMATION OPTIONS

The triangle icon to the right of the animation controls displays the Auto-Key Framing option menu. This menu lets you turn the animation system on or off.

When the animation system is enabled, every change you make to the scene is recorded as a key event. Changes can include things like moving an object, changing a material, or changing the shape of a terrain.

When the animation system is disabled, your changes are not recorded. To record a key event you have to use the Add Key Frame button. The animation system is enabled by default.

This menu also contains the following:

- Ticker Marks lets you select from frame or time options.
- Play mode lets you choose Once, Repeat, or Pendulum.
- Time display is either SMPTE or Frame.

MOTION PATHS

A motion path is a visual representation of an object's trajectory as it moves through time.

An object's motion path is automatically generated as you create key events. Each new key event adds a new point to the path.

The shape of the curve is determined by the interpolation performed by Bryce. In most cases Bryce tries to create smooth motion so the path is drawn as a curve.

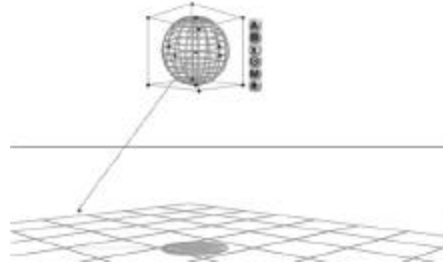

An object's motion path is automatically generated as you create key events. As you move the object at a specific point in time, the motion path line extends out from the object's wireframe.

As you add key events, the curve is adjusted to include the new motion.

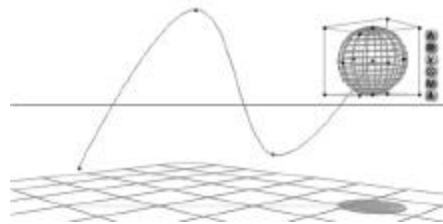

As you add more key events to your animation, the path changes shape to include the new motion. Bryce always keeps the motion smooth, so each new point is added as a curve.

Motion paths exist in 3D space so they can be viewed from any angle. If you move the camera, you can see how the object moves along the X, Y and Z axes.

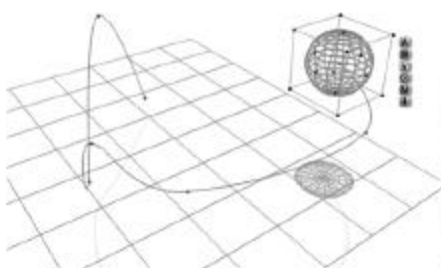
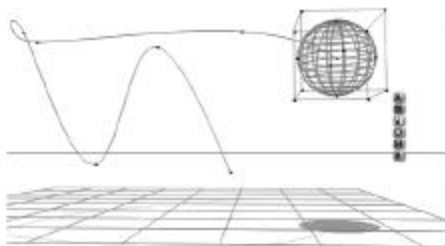

If you move the camera to different views, you'll be able to see the object's trajectory along all three axes.

The default state of the motion path can be difficult to see in a complex scene. You can give your motion path some extra depth by displaying it as a ribbon.

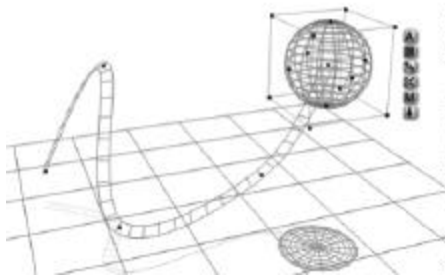

The ribbon lets you see the motion path as a flat track running through the scene.

By default, the motion path for an object only appears when the object is selected. Otherwise the path is invisible. As well, it does not render in the final animation.

You can change the display mode of the motion path in the Animation tab of the Object Attributes dialog.

To show the motion path as a ribbon:

- 1 Select the object.
- 2 Click the A icon that appears next to its bounding box. The Object Attributes dialog appears.
- 3 Click the Animation tab.
- 4 Enable the Show as Ribbon option and click the OK icon.

To display the path only when the object is selected:

- 1 Select the object.
- 2 Click the A icon that appears next to its bounding box. The Object Attributes dialog appears.
- 3 Click the Animation tab.
- 4 Enable the Show Only when Selected option and click the OK icon.

To display the path at all times:

- 1 Select the object.
- 2 Click the A icon that appears next to its bounding box. The Object Attributes dialog appears.
- 3 Click the Animation tab.
- 4 Enable the Show Always option and click the OK icon.

Editing Motion Paths

Changing the shape of the motion path changes the trajectory of the object. The path acts like a Bezier curve. You can change its shape by dragging its control points.

You don't have to be in Auto-Record mode to edit the path. The changes you make to the path's shape are applied directly to the path in real time.

Changing the shape of a path does not affect when key events occur. A key event that occurs at 00:00:01.00 will still occur at the same time regardless of where it is.

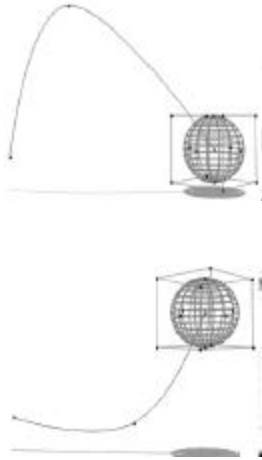

The events on the path above occur at 00:00:00.01, 00:00:01.00 and 00:00:02.00. When you change the shape of the path, the direction in which the object travels changes, but all the events still occur at the same time they did in the original path.

Since Bryce treats the motion path as a Bezier curve, you can edit it just as you would any curve in any 2D illustration application. You can also display the curves tangents which indicate the angle of the curve.

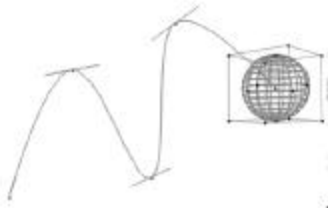

When you display a path's tangents you can see the angles of its curve points.

MOTION PATH MODIFIERS

There are a number of modifiers you can apply to the path change the way motion occurs along the path.

Normally an object moves from the first key event on the path to the last over the course of the animation. If you want the object to move backwards along the path, or repeat its action, you would have to reposition the object and set up new key events. The modifiers let you create these types of effects automatically.

For example, if you wanted to animate the motion of a grandfather clock pendulum, you have to set up the forward motion, and then the backward motion.

However, using the Pendulum modifier you just have to set up the forward motion path since the modifier changes the object's behavior so that it moves forward then back along the same path during the course of the animation. All you have to do to see the new motion is extend the duration of the animation.



The motion of the bird's wings was created using the Pendulum modifier.

There are four modifiers available:

- Make One Shot restores the motion of the path to its original configuration, meaning the action along the path only occurs once.
- Make Repeat creates a loop in the action. The motion on the path repeats continuously.
- Make Pendulum creates a repeating cycle in the action along a path. The object will move forward on the path, then back and then forward continuously.

- Make Circular closes the path to create a circular path. The object will move along the path and when it reaches the end, it'll swing around to the front of the path and start all over.

To apply a modifier to a motion path:

- 1 Select the object.
- 2 Click the A icon that appears next to its bounding box. The Object Attributes dialog appears.
- 3 Click the Animation tab.
- 4 Enable a modifier.
- 5 Extend the duration of the animation so you can see the change in motion.

MOVING THE PATH

You can also move the path, by dragging it to a new location. When you drag the path, all the events on the path shift position. Changes in motion path position are not recorded as key events.

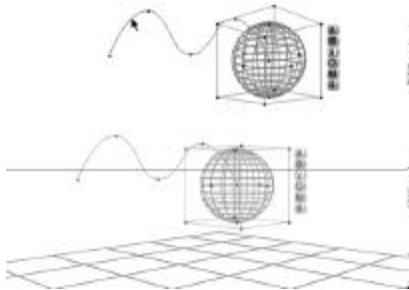

When you drag the motion path, you're not changing its shape, you're adjusting the position of all the events on the path, so this animated ball occurs at a higher altitude.

To move a motion path:

- Click on a section of the path that does not contain any control points and drag it to new location.
You have to click on a part of the path without control points, otherwise you'll change its shape.

ALIGNING OBJECTS TO THE PATH

Normally, the orientation of an object remains fixed relative to world space as it moves from point to point. Using the aligning option, you can have the object's orientation remain parallel to the path so that it reorients itself as moves from point to point

You can use this option to create more realistic motion for objects that have a distinct front and back.



The motion of this airplane looks rather unrealistic since its rising and falling without tilting.



If you align the airplane to its path, the airplane's nose tilts down as it moves down and up as it moves up.

There are two align options available:

- Do Not Align disables aligning. The shape of the curve has no effect on the object's orientation.
- Align adjusts the object so that its orientation matches the shape of the path.

To align an object to a motion path:

- 1 Select the object.
- 2 Click the A icon that appears next to its bounding box. The Object Attributes dialog appears.
- 3 Click the Animation tab.

- 4 Enable an alignment option and click the OK icon.

ADVANCED MOTION LAB BUTTON

The Advanced Motion Lab button opens the Advanced Motion Lab.



Use the Advanced Motion Lab button to enter the Advanced Motion Lab.

THE ADVANCED MOTION LAB

The Advanced Motion Lab contains tools that let you control the detailed properties of your animation.

You can use the lab to:

- view the hierarchical structure of your scene
- rearrange the sequence of key events for individual object properties
- remap the time it takes to move from one key event to another
- preview your animation

Time Mapping Curve Editor Preview Area

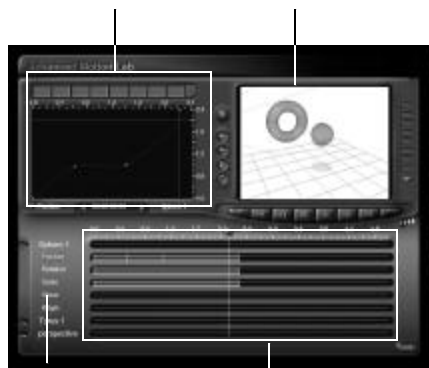

Hierarchy List Area Sequencer

The Advanced Motion Lab lets you control the speed of objects along a motion path and the placement of key frames on the timeline.

The Advanced Motion Lab is divided into four areas:

- The Hierarchy List area, located in the bottom-left corner of the window.
- The Sequencer area, in the bottom-center of the window.
- The Time Mapping Curve Editor, located at the top-left of the window.
- The Preview Area, located at the top right of the window.

HIERARCHY LIST AREA

The Hierarchy List Area displays the scene's hierarchical structure, including links, and groups. You can view all the hierarchies expanded or just the parent objects in the scene. You can also expand an object's listing to show all of its properties.

The Hierarchy List area is used to control the display of both the object hierarchies and object property timelines. If you want to view only your scene's object hierarchies you'll have to hide all the properties for all objects. You can hide each object individually or select from the menu to the right of the Preview Area to display or not display the hierarchy.

Refer to "Object Hierarchies" on page 221 for more on object hierarchies.

TO HIDE AN OBJECT'S PROPERTY TIMELINES:

- To hide an individual object's property timelines, click the name of the object whose properties you want to hide.
- To hide all the property timelines in the Hierarchy List area, either hold down Option/Alt while you click, or select Collapse All Timelines from the menu to the right of the Preview Area.

When all the object timelines are hidden, the only thing displayed in the Hierarchy Area is the hierarchical structure of your scene.

The Hierarchy List can be viewed in two ways: collapsed or expanded. You can use the arrow icons to expand or collapse the Hierarchy. When the Hierarchy List is collapsed you can only see the Parent objects in the object hierarchies.

When it's expanded, you can see all child objects in the hierarchy.

The indents indicate Parent-child links or groups. The parent is aligned to the left, and its children are indented from there.

To display or hide the hierarchical relationship:

- To display the hierarchical relationship in the Hierarchy List area, select Display Hierarchy from the menu to the right of the Preview Area.
- To hide the hierarchical relationship in the Hierarchy List area, deselect Display Hierarchy from the menu to the right of the Preview Area

To expand/ collapse the Hierarchy List:

- To expand or collapse individual items in the Hierarchy List, click the Arrow icon beside an object's listing.
- To expand the entire hierarchy, hold down Option/Alt and click an arrow, or select Expand All Hierarchies from the menu to the right of the Preview Area.
- To collapse all hierarchies, select Collapse All Hierarchies from the menu to the right of the Preview Area.

A right facing arrow indicates a collapsed hierarchy, and a down-facing arrow indicates an expanded listing.

THE SEQUENCER

The Sequencer lets you see the key frames recorded for each property within an object. Each property has its own timeline *track*. Key frames are displayed as white marks on the timeline. The current time is indicated by the Current Time bar.

The Sequencer lets you see where in time a change in an object's property occurred and edit the position of that event. Different types of objects have different properties.

A scene contains more than just objects. You can expand the Hierarchy List to also display the properties for your scene's sky and the camera.

The display buttons along the left side of the hierarchy area let you hide or display an object in the animation preview. This can help you isolate objects in a complex scene.



Use the display buttons to hide or show objects in the animation preview.

EDITING PROPERTY TIMELINES IN THE SEQUENCER

Each object in the Hierarchy List has a number of timelines associated with it. When you display an object's properties you can see the timelines associated with each object.

To display an object's property timelines:

- To display an individual object's property timelines, click the name of the object whose properties you want to display.
- To display all the property timelines in the Hierarchy List area, either hold down Option/Alt while you click, or select Expand All Timelines from the menu to the right of the Preview Area.

These timelines represent the various animatable properties for an object type. Different types of objects have different animatable properties.

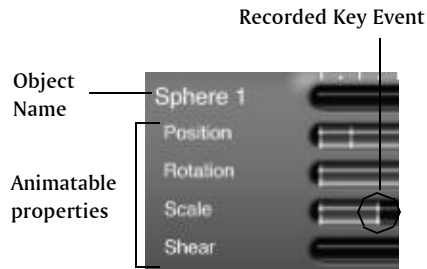

For example, this is the listing for a sphere object. When the object's property timelines are displayed, you can see the key events recorded for each property.

The white tick on a property timeline indicates that a key event has been recorded for the property.

The ruler at the top of the Sequencer lets you see the exact point in time when the key event was recorded.



You can tell exactly when an event was recorded by lining the key event marker up with the ruler at the top of the Sequencer area.

In this example, a position key event was recorded at time 00:00:01.25 (or 1 second and 25 frames)

By moving these key events you can control precisely when events occur.

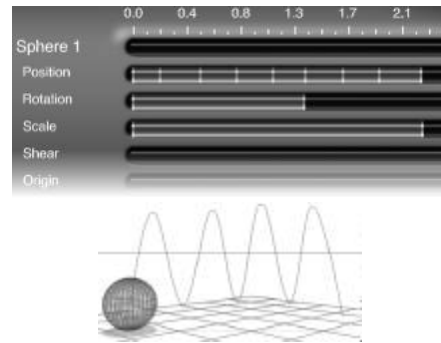

This sequence represents an animation where a ball moves up and down four times, rotates as it makes its third jump and shrinks when its done bouncing.

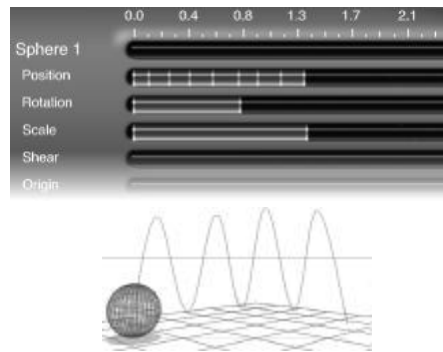

If you move the position key events closer together the bounces occur faster, but the timeline remains the same.

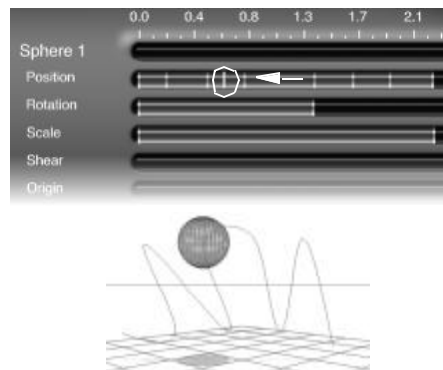

If you move the fourth position key event in front of the third event, you're changing the shape of the motion path, because the ball bounces up before it bounces down.

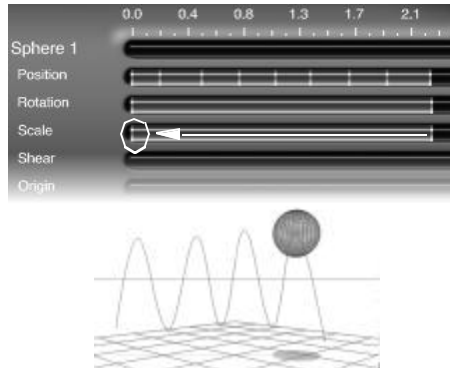

Position is not the only key event you can arrange. Here both the rotation and scale key events have been repositioned. Now, the ball grows larger as it bounces and it rotates only at the end of the animation.

It's a good idea to activate the continuous preview while editing the timeline, so you can quickly see the effects of your changes. Refer to "Previewing Animations" on page327 for more on previewing.

The amount of time available in the Sequencer area is not limited by the current Animation Range. If you position a key event past the current limit of your animation, the Animation Range is automatically extended.

To MOVE A KEY EVENT ON A TIMELINE:

- 1 Expand the listing you want to edit.
- 2 Click the white tick mark on the listing's timeline.
- 3 Drag the key event to a new position.

To MOVE A GROUP OF KEY EVENTS:

- 1 Drag a marquee around all the key events you want to select or hold down Shift and click each of the key events you want to move.
You can select key events on different timelines.
- 2 Drag one of the selected key events. All the other selected key events movealso.

To DELETE A KEY EVENT FROM A TIMELINE:

- 1 Select the key event, or group of events you want to delete.
- 2 Press Backspace (on some Macintosh keyboards, the backspace key may be labelled "Delete"). The key event is removed from the timeline.

To COPY A KEY EVENT ON A TIMELINE:

Hold down Command/Ctrl and drag a key event. The original remains in place, but the copy moves as you drag.

TIME MAPPING CURVE EDITOR

The Time Mapping Curve editor lets you control the length of time between key events. Each property listing in the Hierarchy List has its own time mapping curve.

The curve acts like a time filter which remaps the time in your animation. Depending on the shape of the curve, the events in your animation may take longer to complete, or may occur very rapidly.

A time mapping curve can speed up events while slowing down others. You can even reverse the action in your animation. Refer to "Time Mapping Curves" on page340 for more on working with Time Mapping Curves.

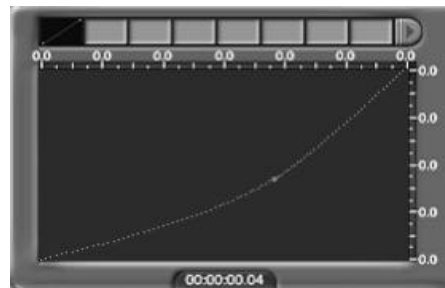

The Time Mapping Curve editor lets you remap the time in your animation.

PREVIEW AREA

The Preview Area in the Advanced Motion Lab contains tools that let you preview your animation.

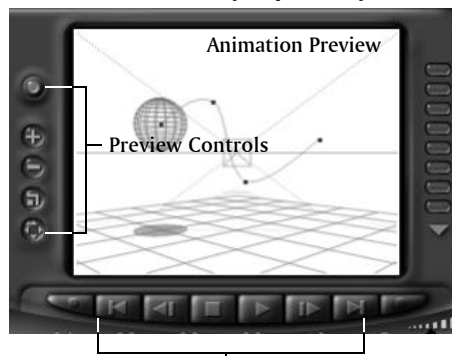

Preview VCR Controls

The Animation Preview area lets you see any changes you make to the timing and velocity of objects.

The Preview Area has three parts:

- The Animation Preview area displays a wireframe preview of your scene. Any changes you make in the Time Mapping Curve editor or the Sequencer are updated to this area.
- The Preview VCR controls let you play the animation like a movie. You can stop, play, move forward one key frame, or back one. The far right button renders the scene.
- The Preview Display Controls let you zoom in/out of the preview, switch between Camera View and Director View, pan the preview and reset the preview.

Once you start the animation, it will run continuously until you press the Stop button. Running the preview also moves the Current Time Bar in the Sequencer area and the cross-hairs in the Time Mapping editor. As well, the counter at the bottom of the Time Mapping editor displays the current time of the animation as it plays.

To preview an animation:

- Click the Play button in the Preview Area controls.



The animation starts running. It will continue playing until you press the Stop button.

Click the Stop button to stop the preview.



The controls along the left side of the Preview Area control several options for your animation preview.

To switch between Camera View and Director's View in the preview:

- Click the Swap Views button next to the Preview Area.



When you first open the Advanced Motion Lab, the Preview Area displays the current camera view.

In Director's View you'll be able to see the camera in the scene.

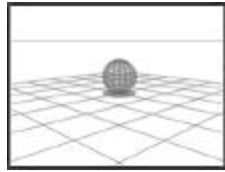

Camera View

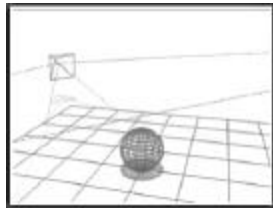

Director's View

When you switch to Director's View in the Preview Area you can see the camera in the scene.

- Click the button again to switch back to Camera View.

Changing views in the Preview Area doesn't affect the view in the Working window.

To RENDER YOUR PREVIEW:

- To render your preview, click the last VCR button under the Preview Area in the Advanced Motion Lab.

To CHANGE THE VIEW IN THE PREVIEW AREA:

- To orbit around your scene, drag the preview in the direction you want to move the view of your scene.

To ZOOM IN AND OUT OF THE PREVIEW:

- Click the + button next to the Preview Area. The view of the scene enlarges.



To RESET THE VIEW IN THE PREVIEW AREA:

- Click the Reset button next to the Preview Area.



The view returns to the view displayed when you first entered the Advanced Motion Lab.

To PAN THE PREVIEW AREA:

- Drag the cursor over the Pan button next to the Preview Area.



Hiding AND Displaying OBJECTS

The Hierarchy List area displays all the objects in your scene. The icons on the left side of the listing indicates whether or not the object is displayed in the preview area.

Visible Object



Hidden Object



The eye icon indicates whether or not an object is hidden.

When you hide an object it does not appear in the Preview Area at the top of the Advanced Motion Lab. This setting has no effect outside the lab. Objects that are hidden in the lab will be visible in the Working window and will still render normally.

You can use this feature to isolate objects that you're editing in the Sequencer or Time Mapping areas.

To hide/display AN OBJECT:

- Click the Eye icon to hide the object.
Click the icon again to display the object.

SAVING PREVIEW POSITIONS

The Memory dots next to the Preview Area let you save specific camera positions in the preview for later use.



The Memory Dots on the right side of the Preview Area let you save positions in the Hierarchy area and the animation preview.

TO SAVE A POSITION:

- 1 Play the animation and then stop it at the point you want to save.
or
Move the Current Time bar in the Hierarchy area to the position you want to save.
- 2 Click on an empty Memory dot on the right side of the Preview Area.
A dot is empty when it appears gray.

TO MOVE TO SAVED POSITION:

- Click on a full Memory dot. A dot is full when it appears purple.

TO DELETE A SAVED POSITION:

- Option/Alt+click on a full Memorydot.

USING PRESETS

Above the Time Mapping Curve Editor are eight time mapping curve presets.

You can create a preset of the current curve then apply it to a different attribute of the same object or to another object.

TO ADD, APPLY, OR REMOVE A PRESET:

- To add a preset, click in one of the blank squares.

- To apply a preset, click in the square that displays the present you want to apply.
- To remove a preset, press Option/Alt and click on the square that displays the preset you want to delete.

When all the preset slots are filled, a new one is automatically generated when you click on the right arrow.

- To scroll to the newest preset or to the next preset in line, click on the end of the preset container.

ANIMATION FEATURES

Bryce has several special features that let you add extra effects to your animations:

- Time Mapping Curves
- Animating Transformations
- Animating Materials
- Animating Terrains
- Animating Skies

TIME MAPPING CURVES

Time Mapping Curves are graphical representations of the time mapping filter. The filter remaps the time in your animation, so that the events that occur at specific times in your animation occur differently in actual time.

By adjusting the shape of the curve, you can control how fast events occur. When you create a sharp jump in the curve, you speed up the events in your animation. When you flatten the curve, you slow down key events.

Each property of your scene can have a different curve, so you can have key events occurring at different speeds. Refer to “Time Mapping Curve Editor” on page337 for more on Time Mapping Curves.

The curve acts like a filter. Time from the actual animation is remapped according to the shape of the curve to produce the final time. Depending on the shape of the curve, events can occur faster, or slower.

Time Mapping curves can only remap the time available in the animation. You cannot add more time, or reduce the amount of time in an animation.

Editing TIME MAPPING CURVES

The horizontal axis in the editor displays all the time in the animation. The vertical axis displays the time map for the properties' timeline. The key events recorded for an object property are displayed as horizontal dotted lines. The curve in the middle represents the time mapping filter. The point where the curve intersects a key event line tells you exactly when an event occurs.

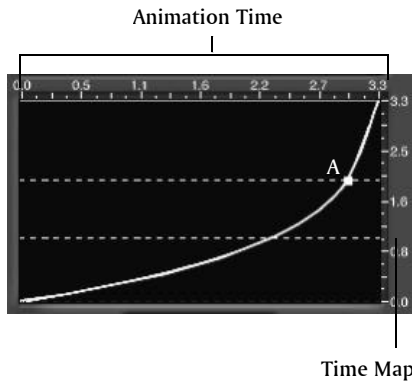

At point A in this timeline, an event that occurred at 2 seconds in the original animation, will occur at 3 seconds after it's passed through the filter.

The default time mapping curve for any property is a diagonal line. In this curve, time is not being remapped since events occur at the same time along both the horizontal and vertical axes.

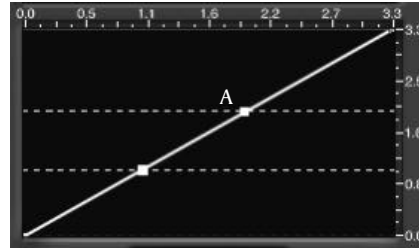

At point A in the default timeline, an event that occurred at 2 seconds in original animation, also occurs at 2 seconds in the time map.

When you change the shape of the default curve, you're remapping time.

For example, if you make the curve convex, events occur later in the animation, but they're closer together which means the action at that point in your animation will speed up.

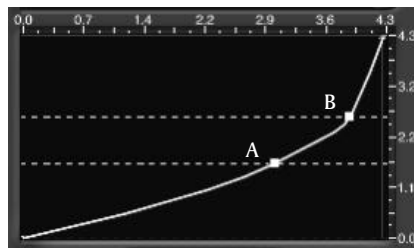

In this example you can see that at point A an event that occurred at 1.5 seconds now occurs at 3.1 seconds. At point B an event that occurred at 2.5 seconds now occurs at 3.9 seconds.

Although both events now occur later, there's much less time between them, so the action in your animation occurs later but the changes at that point are faster.

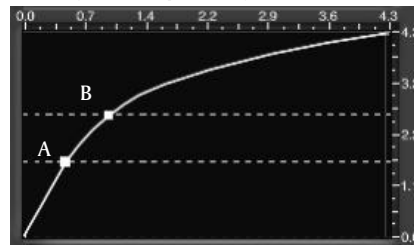

A concave curve would create the same type of effect, except that the events occur earlier. Here, event A and B occur much

earlier, within the first second, and the amount of time between them is much less.

Different curve shapes represent different time mapping effects. A flat curve means that no motion is occurring since all the events on the curve are happening at exactly the same point in time.

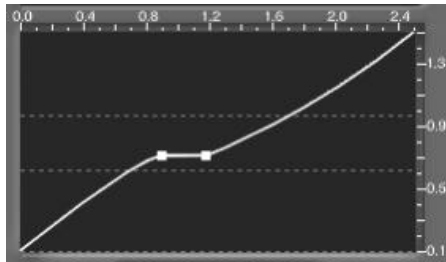

This curve indicates that a pause occurs during the course of the animation.

A steep jump in the curve indicates a sharp increase in speed, as many events occur in a very short time.

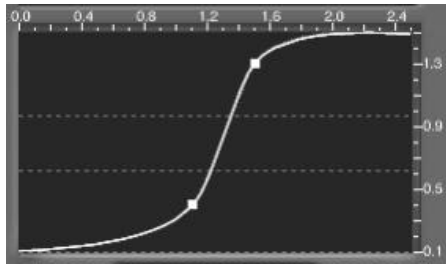

This curve indicates a sharp increase in speed.

An oscillation in the curve, indicates that events repeat, since they intersect the curve more than once.

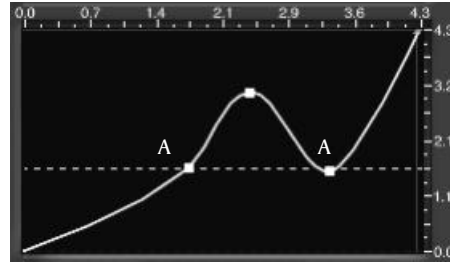

In this curve event A occurs once at 1.5 seconds and again at 3.5 seconds.

You can combine any variation of curve slopes to create different velocity effects.

While you're editing a Time Mapping curve, you may want to continuously run the animation preview. As the preview runs, the cross-hairs in the Time Mapping editor move from the beginning of the animation to the end. This way you can quickly see the effects of your edits. Refer to "Previewing Animations" on page 327 for more on continuous preview.

The counter at the bottom of the editor shows you the current time of the animation. As the animation runs, the counter updates to continuously show the current time.

You can also move the current time by dragging the Current Time bar in the Hierarchy area.

To edit a TIME MAPPING CURVE:

- 1 Display the Advanced Motion Lab.
- 2 Click the name of the object whose properties you want to remap
- 3 Click the name of the property you want to remap.
- 4 In the Time Mapping Editor, click a point on the curve and drag it to a new location.
 - If you move over an existing point the cursor changes to cross-hairs.
 - If there is no point on the curve, the cursor turns into a pen.

- 5 Continue dragging points until you achieve the desired shape.

To zoom into an area of the Time Mapping curve:

- 1 Move the cursor over the curve in the Time Mapping Editor.
- 2 Click and drag over an area of the curve. When you release the mouse, the area is enlarged.

To zoom out of an area in the Time Mapping curve:

- Hold down the Shift key and click inside the Time Mapping Editor.

To pan the Time Mapping curve:

- To pan, press the Spacebar and drag the curve in the editing window.

To reset the view in the Curve Editor, press Command/Ctrl + Shift + Click.

ANIMATING TRANSFORMATIONS

When you're in Auto-Key mode, every transformation you apply to an object is recorded as a key frame.

In the Hierarchy area you can see where the key frames for these transformations appear in the timeline. By moving these key frames you can control the order in which transformations are applied. For example, you can take an object that grows larger and then moves left, and turn it into an object that moves left and then grows. Several animation techniques, like squash and stretch, can be simulated using transformations.

Refer to "Animating Transformations" on page343 for more on animating transformations.

ANIMATING MATERIALS

The Materials Lab has its own set of animation tools that let you animate material properties. You can animate almost any property or texture.

When you're animating between textures, Bryce interpolates between patterns and colors over time. You can have a rocky terrain turn into a desert during the course of your animation.

Refer to "Animating Materials" on page350 for more on animating materials.

ANIMATING TERRAINS

The Terrain Editor has a set of animation tools that let you animate a terrain over time. You can animate the shape of the terrain, or the filtering effects like Erosion or Mounds.

Using these tools, you can create a terrain that changes shape as time passes.

Refer to "Animating Terrains" on page357 for more on animating terrains.

ANIMATING SKIES

The Sky & Fog palette and the Environmental Attributes dialog have a number of controls that let you set the properties of your environment. By changing these properties over the course of an animation, you can animate your environment. For examples, you can make clouds move, or gradually change the time of day.

Refer to "Animating Skies" on page354 for more on animating skies.

ANIMATING TECHNIQUES

Bryce has several features you can use to add realism to your animations. The techniques covered in this chapter can be used together to help you develop more exciting, natural and dynamic animations.

In this section, you'll learn how to animate objects using the Tracking feature. You'll also learn how to animate several different properties of your scene like material channel properties, which can

dramatically alter the look of your objects, and terrain object properties, which can alter the layout of your landscape.

TRACKING OBJECTS

Tracking lets you connect an object to another, called the *target*, so that the object remains pointed at the target throughout the animation.

As the target moves, the original object pivots around its origin so that it remains pointed at the target. Normally, the original object does not change position, only orientation. However, if you offset the object's origin point, it might change location as it rotates around the offsetpoint.

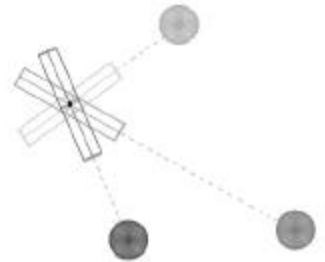

The original object pivots around its origin point so that it's always facing the target object.

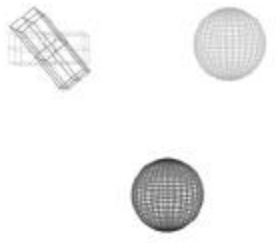

When an object tracks a target object, it remains pointed at the target object no matter where it moves in the scene.

You can use tracking to quickly set up the animation of a number of objects at once. When an object is tracking another, you only have to set up the motion path of the target object. The motion of the objects tracking the target are automatically created.

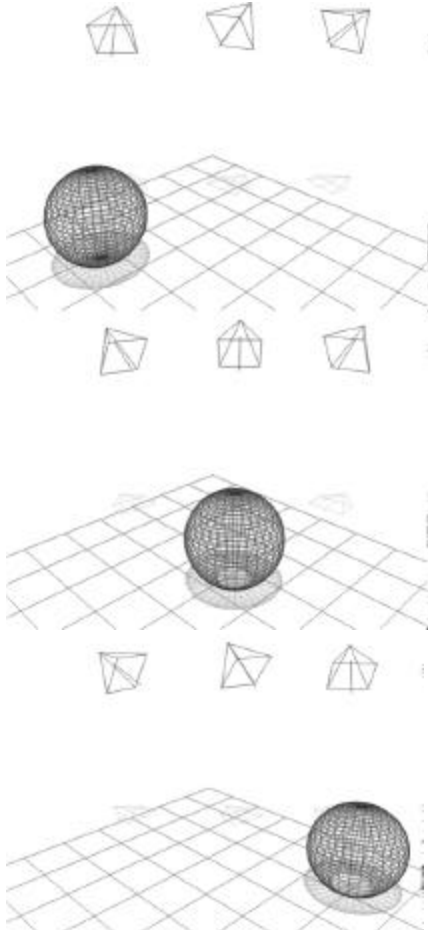

For example, in this scene the motion of all the lights is created when you move the target object.

You can use this feature to ensure that a light or the camera remains pointed at an object during the entire course of the animation. You can also use it to create motions like a radar dish following a satellite or a sunflower following the sun.

A parent object cannot track its child object.

To SET UP OBJECT TRACKING INTERACTIVELY:

- 1 Select the object you want to remain stationary (that is, the one that tracks the target object).
- 2 Move the cursor over the target icon that appears next to the object's bounding box.
- 3 Drag the Target line from the icon to the target object. The target object turns blue.

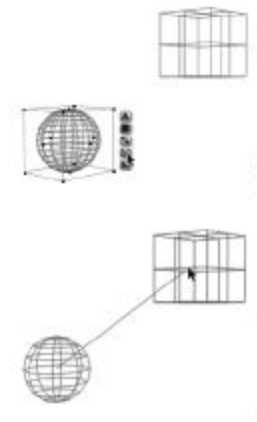

As you drag the Tracking icon from the tracking object to the target, a tracking line appears.

To SET UP OBJECT TRACKING USING THE OBJECT ATTRIBUTES dialog:

- 1 Select the object you want to remain stationary.
- 2 Click the A icon that appears next to the object's bounding box. The Object Attributes dialog appears.
- 3 Click the Linking tab.
- 4 Click the Target Object Name menu and choose the name of the target object.

ANIMATING THE CAMERA

When you animate the camera, you're changing the view of your scene over the course of the animation. Since you're in 3D space you can move the camera to any position in the scene. You can have your camera circle around the scene, zoom into it or even fly under it.

There are two ways of animating the camera in Bryce: using the Camera Position controls, or by moving the camera as an object.

The easiest way of animating the camera is to use the Trackball, (or other Camera Position controls) in Camera View while Auto-Key mode is enabled. Any changes you make to the position of the camera are automatically recorded as part of a key event. When you play the animation, your camera changes are added to all the other changes in scene properties to create the action in your animation.

While working in Camera View may be the easiest way of animating the camera, it's not the most precise. Because of the view's first person perspective, it can be hard to see the exact path of the camera as it moves. This can make creating a precise motion difficult.

However, if you switch views, to an orthogonal view or the Director's View, you'll be able to see the camera as an object in the scene. Then you can select the camera and set up key events for its position, just as you would for any other object. Also, you can display the camera's motion path so you can make precise adjustments to its movements.

After you're done setting up the key events for the camera, you can see the changes in the Sequencer in the Advanced Motion Lab. There you can rearrange the order of events or change how long it takes to move between camera positions. Refer to "Object Hierarchies" on page221 for more on working in the Hierarchy, or "Time Mapping Curves" on page340 for more on remapping time.

CAMERA MOTION AND Skies

The motion of sky elements can affect how fast the action in your animation appears. For example, in time-elapsd movies, the clouds and sun fly by quickly as the objects stay in the same position. You could inadvertently create this type of action in your scene if you move only the camera in the scene without considering the static nature of the sky elements. Since the clouds stay in exactly the same position as you move the camera, they'll appear to be moving much faster than the objects in the scene.

To avoid this problem, Bryce lets you link the clouds to the camera. This way, whenever the camera moves, the cloud positions also move, so they look like they're staying in the same position.

Although you can also link the sun to the camera, it's not a very good idea to link the two during an animation since any change in the camera position will change the time of day.

To link clouds to the camera:

- 1 Display the Sky&Fog palette.
- 2 Click the triangle icon in the bottom right corner of the palette and choose Sky Lab from the menu. The Sky Lab dialog appears.
- 3 Click the Cloud Cover tab.
- 4 Click the Link Clouds to View button at the bottom of the palette.
- 5 Click the OK icon to exit the palette.

Using the Orthogonal Views

In Camera View you can't see the physical position of the camera in the scene since you're looking through it, but using one of the Orthogonal views (Top, Bottom, Left, Right, Front and Back) you'll be able to see the camera as an object.

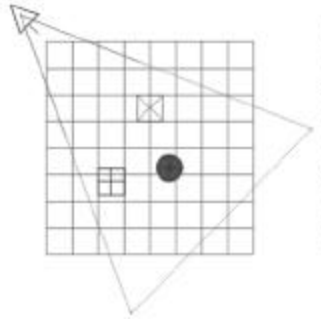

In this example, the scene is displayed in Top view. Here you can see the exact position of the camera in the scene.

In these views you can animate the camera by changing its position at different points in time. When you run the animation, Bryce fills in the gaps between positions to create smooth camera motion.

TO ANIMATE THE CAMERA IN AN ORTHOGONAL VIEW:

- 1 In the Working window, click the triangle icon next to the View Control and choose an orthogonal view from the menu: Top, Left, Right, Bottom, Front or Back.
- 2 Move the Current Time Indicator in the Timeline to the point where you want to start changing the Camera View.
- 3 Click the triangle icon in the Animation controls and make sure Auto-Key is enabled.
- 4 Drag the Camera wireframe in the Working window to a new position.
- 5 If you want to see the results of your changes, choose Camera View from the View Control menu and click the Play button in the Animation controls.

Using DIRECTOR'S VIEW

Director's View is similar to Camera View, except that in this view, you can see the camera as an object in the scene and the movements of the Director's camera are not recorded as key events.

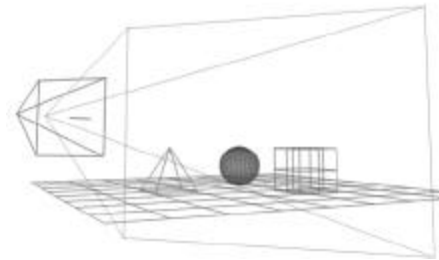

In Director's View you see the camera as an object in the Working window. You can change this view using any of the Camera Position controls in the Control Palette.

In Director's View, you can move the view of the scene using the Trackball or the Camera Position tools. The view of the scene changes in the Working window, but no new key events are created.

You can also preview the animation while in Director's View. In the Working window you can see all the objects moving along their motion paths—including the camera.

TO ANIMATE THE CAMERA USING DIRECTOR'S VIEW:

- 1 In the Working window, click the triangle icon next to the View Control and choose Director's View from the menu.
- 2 Move the Current Time Indicator in the Timeline to the point where you want to start changing the position of the camera.
- 3 Click the triangle icon in the Animation controls and make sure Auto-Key is enabled.
- 4 Drag the Camera wireframe in the Working window to a new position.
- 5 If you want to see the results of your changes, click the Play button in the Animation controls.

Displaying THE CAMERA'S TRAJECTORY

If you're setting up a precise path for the camera, you may want to display its motion path. Just like with other motion paths, you adjust the trajectory

of the camera by adjusting the shape of the path. Refer to “Editing Motion Paths” on page331 for more on working with motion paths.

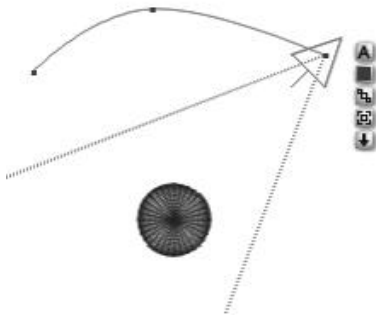

When you display the camera's trajectory, you can see the exact path it will take during the course of the animation.

To display the camera's trajectory:

- 1 In the Working window, click the triangle icon next to the View Control and choose: Top, Left, Right, Bottom, Front or Back from the menu.
- 2 Select the Camera in the Working window.
- 3 Click the A icon that appears next to the camera's bounding box. The Camera & 2D Projection dialog appears.
- 4 Click the Animation tab.
- 5 Click the Show Trajectory option and click the OK icon.

LINKING AND TRACKING WITH THE CAMERA

Since Bryce lets you treat the camera as an object, you can also link the camera to an object, or you can have it track an object.

When you link the camera to an object, the view of the scene changes as the position of the parent object changes.

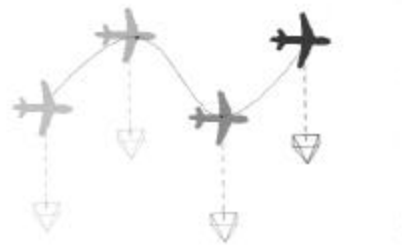

If you link the camera to an airplane, the view of the scene will follow the airplane's trajectory as it moves along its motion path.

When the camera is linked to an object, both its aim and position change as the object changes.

When you set the camera to track an object, the camera remains pointed at the target object no matter where the object moves in the scene. This means the Trackball is disabled because the orientation of the camera is controlled by the position of the target object. Also, you can't change the aim of the camera because it always aims at the target object.

However, you can position the camera using the Camera controls as these controls change the position of the camera not its orientation.

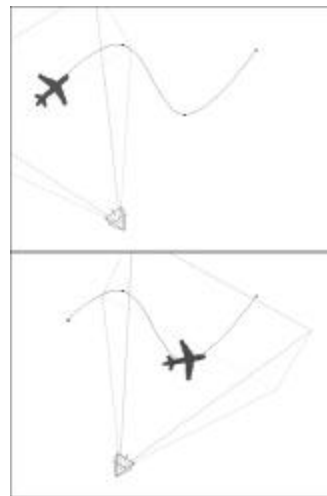

If you have the camera track an airplane, the view of the scene will follow the airplane's trajectory.

Linking the camera can cause unpredictable movements when you're in Camera View. If you change the position of the target object, the view of the scene will also shift.

To link the CAMERA TO AN OBJECT USING THE CAMERA & 2D PROJECTION dialog:

- 1 Switch to an orthogonal view or Director's View.
- 2 Select the camera.
- 3 Click the A icon that appears next to the camera's bounding box. The Camera & 2D Projection dialog appears.
- 4 Click the Linking tab.
- 5 Click the Object Parent Name menu and choose the name of the object you want to use as the parent object.
- 6 Click the OK icon to link the two objects.

You can also access the Camera & 2D Projection dialog by double-clicking the Trackball, or by clicking the triangle icon beside the Camera controls and choosing Edit Current Camera from the drop down menu. Only the Camera & 2D Projection tab will be available when you access the dialog using one of these methods.

To link the CAMERA TO AN OBJECT INTERACTIVELY:

- 1 Switch to an orthogonal view or Director's View.
- 2 Select the Camera.
- 3 Move the cursor over the Link icon that appears next to the camera's bounding box.
- 4 Drag the linking handle from the icon to the object you want to use as the parent object.

To FORCE THE CAMERA TO TRACK AN OBJECT USING THE CAMERA & 2D PROJECTION dialog:

- 1 Switch to an orthogonal view or Director's View.
- 2 Select the camera.

- 3 Click the A icon that appears next to the camera's bounding box. The Camera & 2D Projection dialog appears.
- 4 Click the Linking tab.
- 5 Click the Track Object Name menu and choose the name of the target object.
- 6 Click the OK icon.

To FORCE THE CAMERA TO TRACK AN OBJECT INTERACTIVELY:

- 1 Switch to an orthogonal view or Director's View.
- 2 Select the Camera.
- 3 Move the cursor over the Tracking icon that appears next to the camera's bounding box.
- 4 Drag the tracking handle from the icon to the object you want to use as the target object.

CREATING CAMERA ORBITS

The camera's origin point controls its center of rotation. When the origin point is at the camera's center, it rotates around in place. When the origin is positioned somewhere in the scene, it will orbit around the origin point. During an animation, the view of your scene will orbit around a specific point in the scene.

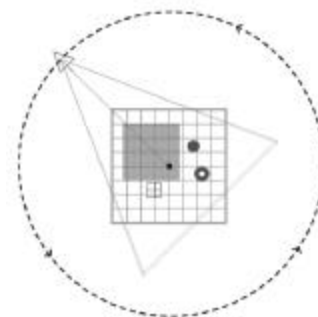

In this example, the camera's origin point was positioned in the center of the scene. During the course of the animation, the camera appears to orbit around the entire scene.

TO CREATE A CAMERA ORBIT:

- 1 Switch to Director's View or one of the orthogonal views.
- 2 Click the triangle icon in the Animation controls and make sure Auto-Key is enabled.
- 3 Click the Camera wireframe in the Working window.
- 4 Click the A icon that appears next to the camera wireframe. The Camera & 2D Projection dialog appears.
- 5 Click the General tab.
- 6 Click the Show Origin Handle button and click the OK icon.
- 7 Drag the origin handle to a position in the scene.
- 8 Rotate the object using the Rotation tool in the Edit palette or the Trackball.



In this animation, the illusion of a banana ripening was created by changing the color and texture of a material over time.

ANIMATING MATERIALS

The action in your scene can include much more than just motion. Many subtle or dramatic effects can be created by changing the properties of an object's surface over the course of the animation.

This section assumes that you're familiar with the concepts and procedures involved in creating material and textures. Refer to "Building Materials" on page 162 for more on creating materials and "Creating and Editing Textures" on page 169 for more on editing textures.

By animating an object's texture you can create subtle effects like changing the color of an object to simulate things like a tomato ripening. You can also create more dramatic effects like changing all the properties of a material at once. Using this technique you can change an object from marble to metal, or glass to wood.

In Bryce, animating materials is a rather straightforward process. Using the animation tools in the Materials Lab you set the properties of a material at different points along the Timeline. When you run the animation, Bryce interpolates between the properties to create a transition from one material to the other.

You can animate any property of a material:

- Colors
- Channel values
- Texture component usage (that is, switching between components A, B, C and D)
- Texture properties
- Volume Material properties

Take care when you're choosing which properties to animate. Some properties, like transparency, and volumetric effects can greatly increase the rendering time of your animation.

Material animations are created using the Animation controls at the bottom of the Materials Lab.

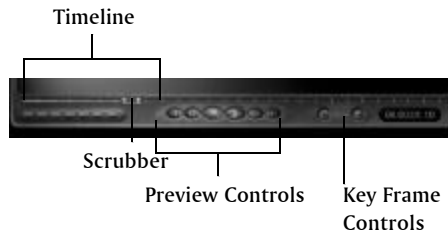

The Animation controls at the bottom of the Materials Lab let you move along the Timeline and preview your animation.

These controls let you move along your animation's timeline. This timeline is the same as the one at the bottom of the Working window. It contains all the same key events as the Working window timeline. The Animation controls in the Materials Lab can perform all the same features as the Animation controls in the Working window.

ANIMATING MATERIAL CHANNEL VALUES

By animating the channels in a material you can alter the properties of a material without changing its basic function. Using this technique, a rock material would still look like a rock, but change color, or glass would still look like glass except become shinier.



In this example, the effect of a cat's eyes growing brighter as the sunlight fades, was created by animating the Ambience channel value.

This is the simplest way of animating a material and it requires the least amount of processing time.

TO ANIMATE A MATERIAL'S CHANNEL VALUES:

- 1 Select an object.
- 2 Click the M icon that appears next to the object's bounding box. The Materials Lab appears.
- 3 Click the triangle icon in the Animation controls and make sure Auto-Key is enabled.
- 4 Move the Current Time Indicator to the point where you want to start changing the material.
- 5 Change the values of the material channels using the Value controls.
or
Change the color used for a channel by using the color picker.
- 6 Move the Current Time Indicator to a different point on the Timeline.

The current time appears in the counter next to the preview controls.

- 7 Change the channel values again.
- 8 Continue moving the Current Time Indicator and changing channel values until you achieve the effect you want.
- 9 Click the OK icon to exit the Materials Lab.

ANIMATING TEXTURE COMPONENTS

Animating a texture component is an effective way of creating motion within a material. When you change the orientation, position or scale within a texture component, the texture elements, (like dots, checks or patterns) will appear to move.

You can use this technique to create realistic wave motion in a water texture. If you change the position of the texture pattern at different points in the Timeline, the waves will appear to move over the surface of the object.



This tide effect was created by changing the makeup of the water texture in the material applied to the water slab.

If you wish to avoid unexpected texture movement during a texture animation, use Object Space mapping mode for the texture. This way the texture moves as the object moves. However, you can create some very interesting effects using World Space.

You can also animate a texture component by altering the makeup of the texture using the Deep Texture Editor. Using the editor you can change the make-up of any or all of the four texture components in a material.

TO ANIMATE A MATERIAL'S TEXTURE COMPONENTS:

- 1 Select an object.
- 2 Click the M icon that appears next to the object's bounding box. The Materials Lab appears.
- 3 Click the triangle icon in the Animation controls and make sure Auto-Key is enabled.
- 4 Move the Current Time Indicator to the point where you want to start changing the material.
- 5 Click the button in the upper left corner of the texture component window. The Edit Texture palette appears.
- 6 Adjust the position, orientation or scale of the texture and click the OK icon to exit the controls.
- 7 Click the pink button in the upper-left corner of the texture component window. The Deep Texture Editor appears.
- 8 Adjust the values of the texture's components and click the OK icon to close the editor.
- 9 Move the Current Time Indicator to a different point on the Timeline.
The current time appears in the counter next to the preview controls.
- 10 Change the texture properties again.
- 11 Continue moving the Current Time Indicator and changing texture properties until you achieve the effect you want.

12 Click the OK icon to exit the Materials Lab.

ANIMATING BETWEEN MATERIALS

Animating channel values or texture components is a good way of creating subtle effects in a material, but to create more dramatic action, you'll need to animate between two completely different materials.

This is how you create a transition from rock to glass, or wood to metal.

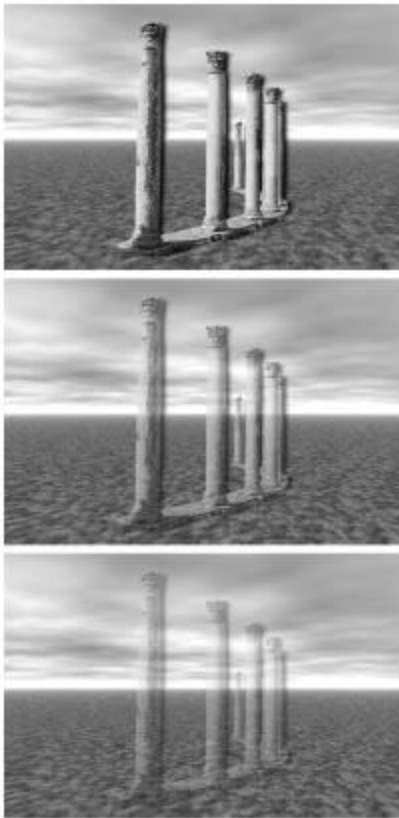

The transition between rock and glass in these temple columns was created using two completely different materials.

Animating between materials is exactly like creating two different materials for the same object. As long as the Auto-Key mode is enabled, all

your settings are recorded as key events, so you can set up a material at one point in time and then move to a different point on the Timeline and create a completely different material.

There are two quick ways of creating different materials:

- By switching the Texture Component used to set a material channel, you can completely change the color, pattern, or bumpiness of a texture.
- Using the Preset Materials Library, you can quickly apply a different material to the object.

TO ANIMATE BETWEEN MATERIALS:

- 1 Select an object.
- 2 Click the M icon that appears next to the object's bounding box. The Materials Lab appears.
- 3 Click the triangle icon in the Animation controls and make sure Auto-Key is enabled.
- 4 Move the Current Time Indicator to the point where you want to start changing the material.
- 5 Set up a material by setting channel values and texture components.
- 6 Move the Current Time Indicator to a different point on the Timeline.
The current time appears in the counter next to the preview controls.
- 7 Set up a different material by choosing different components or applying a preset.
- 8 Click the OK icon to exit the Materials Lab.

PREVIEWING MATERIAL ANIMATIONS

Any change you make to a material's properties are displayed in the Material Preview area. When you play a material animation, the same preview area shows you the transition of the material from one key event to the other.

This is not the most effective way to see a material animation. The best way of seeing a material transformation is by rendering the scene.

TO PREVIEW A MATERIAL ANIMATION:

- Click the Play button in the Animation controls at the bottom of the Materials Lab.

Click the Stop button to stop the preview.

ANIMATING SKIES

All the properties of a Bryce sky can be animated. This means that any attribute you can set in the Sky & Fog palette or the Sky Lab dialog can be animated using the Animation controls on the Timeline.

This section assumes that you're familiar with the concepts and procedures involved in creating skies. Refer to "Creating Skies" on page 241 for more on creating skies.

By changing the attributes in the Sky & Fog palette at different points in the timeline, you can animate everything from the position of the sun to the color of the clouds.

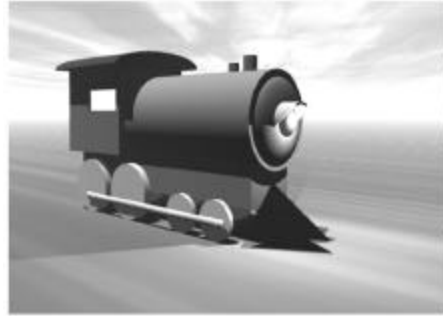

For example, you can simulate changes in the time of day by changing the position of the sun over time.

There are several techniques you can use to add motion to your skies. You can animate all or some of the properties of your sky. You can activate and deactivate sky effects at different points in the animation. You can also animate the position of the sun or moon.

Sky animations are created using the Animation tools in the Working window and the Sky Lab dialog.

ANIMATING Sky & Fog SETTINGS

Animating Sky & Fog settings changes the properties of a sky over time. For example a scene can become cloudier, or darker during an animation. The intensity of the change depends on how many properties you adjust and the amount of each adjustment.



In this example, the animation of approaching storm clouds was created by changing the Cloud Frequency and Amplitude value and the Cloud Color at different points in the Timeline.

Most Sky & Fog properties can be changed using the thumbnail controls. Other settings are available in the Sky Lab dialog.

You won't be able to see the effects of a sky animation until you render the entire animation.

TO ANIMATE Sky & Fog SETTINGS:

- 1 Click the triangle icon in the Animation controls and make sure Auto-Key is enabled.

- 2 Move the Current Time Indicator to the point in the Timeline where you want the sky to change.
- 3 Adjust the sky's properties using the Sky & Fog palette controls.
- 4 Move the Current Time Indicator to a different point on the Timeline.
- 5 Change the properties of the sky again.
- 6 Continue moving the Current Time Indicator and changing the sky's properties until you achieve the desired effect.

ANIMATING Clouds

You can create the effect of wind in your environment by setting up cloud motion parameters. Based on your settings, Bryce automatically moves the clouds in your environment to create motion.

Cloud motion parameters are set in the Sky Lab dialog.

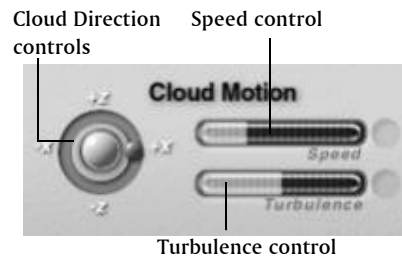

The Cloud Direction control lets you set the direction for cloud motion, while the other controls set the speed and distortion of the clouds.

TO ANIMATE clouds:

- 1 Click the triangle icon in the Animation controls and make sure Auto-Key is enabled.
- 2 In Sky & Fog palette, click the Sky Lab button. The Sky Lab dialog appears.
- 3 Click the Cloud Cover tab.

- 4 Move the direction indicator in the Cloud Motion controls to set a direction for the clouds as they move in the animation.
- 5 Adjust the speed control to set how fast the clouds move. You can also enter a speed value.
- 6 Adjust the Turbulence control to set how much the clouds will distort as they move. You can also enter a turbulence value.

ANIMATING ENVIRONMENTAL EFFECTS

Many environmental effects like rainbows and fog are not permanent features of a sky. They appear for a brief time and then fade away. You can simulate this action by changing the properties of the environmental effects at different points along the Timeline.

Environmental effects controls are located on the Atmosphere tab of the Sky Lab dialog. You can also animate the various settings for an effect. For example, the radius of moon rings can increase or decrease during the course of your animation.

TO ANIMATE ENVIRONMENTAL EFFECTS:

- 1 Click the triangle icon in the Animation controls and make sure Auto-Key is enabled.
- 2 Move the Current Time Indicator to the point in the Timeline where you want the sky to change.
- 3 Display the Sky Lab dialog: Atmosphere tab and change the properties of an effect.
- 4 Move the Current Time Indicator to a different point on the Timeline.
- 5 Change the properties of the effect again.
- 6 Continue moving the Current Time Indicator and changing the effect's properties until you have the desired effect.

ANIMATING SUN OR MOON POSITION

One of the most spectacular effects you can create using the scene's sky is elapsed time. In the great outdoors we perceive time in relation to the position of the sun and the brightness of the sky. By changing the position of the sun or moon you can simulate time passing in terms of days or months.



In this example, the passage of time is simulated by the change in the sun's position.

Since all the elements in the sky are linked, the other properties of the sky like Ambient Light change as the position of the sun changes, adding to the realism of the effect.

For the moon, you can also change its phases, so you simulate the passage of an entire month just by adjusting the moon attributes.

TO ANIMATE SUN OR MOON POSITION:

- 1 Click the triangle icon in the Animation controls and make sure Auto-Key is enabled.
- 2 Move the Current Time Indicator to the point in the Timeline where you want the sky to change.
- 3 Adjust the position of the sun or moon using the Sun Position control in the Sky & Fog palette.
- 4 Move the Current Time Indicator to a different point on the timeline.
- 5 Change the position of the sun or moon again.
- 6 Continue moving the Current Time Indicator and changing the sun or moon position until you achieve the desired effect.



The appearance of cracks in the earth during an earthquake, can be created by animating the geometry of the terrain.

ANIMATING TERRAINS

Terrain objects are animated by changing their properties in the Terrain Editor.

This section assumes that you're familiar with the concepts and procedures involved in creating terrains. Refer to "Elevation Tools" on page 99 for more on creating and editing terrains.

By changing the shape of your landscape at different point on the Timeline you can simulate geological events like earthquakes or erosion.

There are several techniques you can use to control how the shape of your terrain changes. You can use the grayscale paintbrush to totally change the geometry of the terrain by adding new peaks and valley, or you can use the Filtering tools to add small changes in elevation to the terrain.

Terrain animations are created using the Animation controls that appear at the bottom of the Terrain Editor.

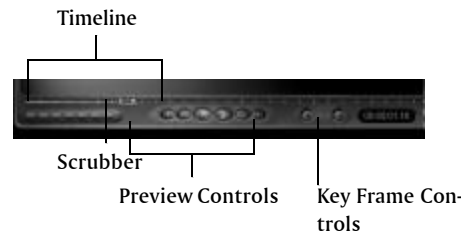

The Animation controls at the bottom of the Terrain Editor let you move along the Timeline and preview your animation.

The Timeline in the Terrain Editor is the same as the one in the Working window. All the key events recorded for object transformations and material changes are displayed in the Timeline. The Animation controls in the Terrain Editor can perform all the same functions as the those in the Working window. Refer to “Creating Animations” on page321 for more on using the animation controls.

ANIMATING TERRAIN GEOMETRY

There are two ways of changing the geometry of a terrain object: by painting directly on the 2D Preview or by applying an elevation effect. When you paint on the canvas you create large changes in the terrain like the creation of new mountains or valleys.



The violent motion of great rock columns shooting up from the ground was created by painting a new peak onto an existing terrain at different points along the timeline.



The appearance of foot prints in the sand was created by painting dark footprint shapes in the 2D Preview at different points in the Timeline.

When you apply an effect you create smaller more subtle changes like a mountain eroding over time.



The rolling motion in this terrain was created by applying the erode effect at one point in the Timeline and then undoing it in another.

You can also use this technique to record how a terrain object was formed. By adjusting the Current Time as you add elements to the terrain, you'll have a complete record of all your steps.

To ANIMATE TERRAIN GEOMETRY:

- 1 Click a terrain object.
- 2 Click the E icon that appears next to the terrain object's bounding box. The Terrain Editor appears.
- 3 Click the triangle icon in the Animation controls and make sure Auto-Key is enabled.
- 4 Move the Current Time Indicator to the point in the Timeline where you want the terrain to change.
- 5 Paint new areas in the terrain using the Grayscale paintbrush.
or
Apply one of the effects in the Elevation tab.
- 6 Move the Current Time Indicator to a different point on the Timeline.
- 7 Change the shape of the terrain again using an effect or the paintbrush.
- 8 Continue moving the Current Time Indicator and changing the terrain's shape until you achieve the desired effect.
- 9 Click the OK icon to exit the editor.

ANIMATING TERRAIN FILTERING

By animating the shape of a terrain object's filtering graph you can create some very specific geometry effects.

For example, you can make specific areas of your terrain sink to simulate the damage caused by an earthquake. To create this effect you would darken only areas you want to sink in the Filtering graph. Likewise, you create the effect of ridges forming by lightening specific areas of the graph.

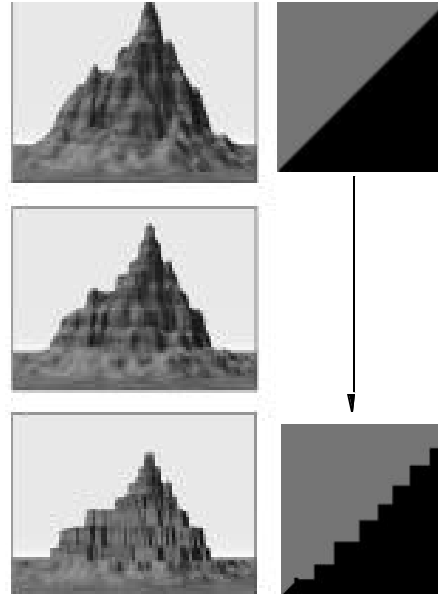

The gradual appearance of stairs in this terrain was created by adjusting the filtering graph at different points in the timeline.

You can also use the Filtering graph to gradually raise or lower the entire terrain over the course of your animation.

To ANIMATE TERRAIN FILTERING:

- 1 Click a terrain object.
- 2 Click the E icon that appears next to the terrain's bounding box. The Terrain Editor appears.
- 3 Click the Filtering tab.
- 4 Click the triangle icon in the Animation controls and make sure Auto-Key is enabled.
- 5 Move the Current Time Indicator to the point in the timeline where you want the terrain to change.
- 6 Adjust the shape of the Filtering graph.
- 7 Move the Current Time Indicator to a different point on the timeline.
- 8 Change the shape of the graph again.

- 9 Continue moving the Current Time Indicator and changing the terrain's graph until you have the desired effect.
- 10 Click the OK icon to exit the editor.

ANIMATING TERRAIN Clipping

The setting of the Terrain Clipping bracket can also be animated. As areas of the terrain are clipped, they're removed from the terrain object in the scene. Your terrain will look like it's breaking up, or like portions it are falling into the sea.



The gradual destruction of this island was created by changing the length of the clipping bracket at different points in the Timeline.

To ANIMATE TERRAIN clipping:

- 1 Click a terrain object.
- 2 Click the E icon that appears next to the terrain's bounding box. The Terrain Editor appears.

- 3 Click the triangle icon in the Animation controls and make sure Auto-Key is enabled.
- 4 Move the Current Time Indicator to the point in the Timeline where you want the terrain to change.
- 5 Adjust the width of the clipping bracket.
- 6 Move the Current Time Indicator to a different point on the timeline.
- 7 Change the width of the bracket again.
- 8 Continue moving the Current Time Indicator and changing the width of the bracket until you achieve the desired effect.
- 9 Click the OK icon to exit the editor.

PREVIEWING TERRAIN ANIMATIONS

Any change you make to a terrain's properties appear in the 3D Terrain Preview. When you play a terrain animation, the same preview area shows you the transition of the terrain from one key event to the other.

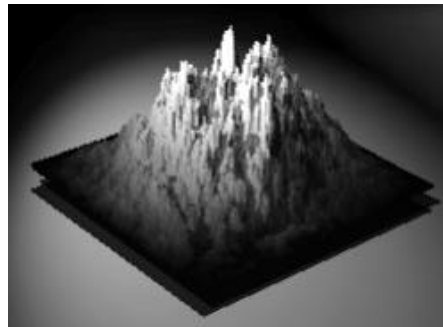

The 3D Terrain Preview displays the preview of your terrain animation.

To PREVIEW A MATERIAL ANIMATION:

- Click the Play button in the Animation controls at the bottom of the Terrain Editor. Click the Stop button to stop the preview.

QuickTime VR

QuickTime VR allows you to take a 360° panoramic image, and make it into a VR Movie; this unique movie will display a 2D panoramic representation of your 3D world, and allow point and click navigation through the world. You can look up, down and around your rendered scene as though you were a camera on a tripod.

Further, QuickTime VR lets you create “Nodes,” or hotspots in the movie where you can click and go to another linked movie. This means you can look around a landscape, and seeing an interesting rock formation in the distance, click on it to view the entire landscape from that new vantage point.

These nodes can also contain “Object Movies;” another specialized technology from Apple that allows you to click and drag to, in effect, “pick up” any object in the VR movie and examine it from all sides, as if you literally picked it up and turned it around and around in your hands.

CREATING QuickTime VR PANORAMAS

The process of creating a panorama involves completing a few easy steps.

TO CREATE QuickTime VR PANORAMAS:

- 1 Choose Default in the Document Setup dialog.
- 2 Click on the uppermost Views Memory Dot in the control palette, to make sure your camera is level.
- 3 Set up your scene.
The important thing to remember is that for a successful 360° scene, you need interesting objects all around your camera. The best way to work on this is to go to the Top View, and position objects all the way around the camera.

- 4 Keep the Nano-Preview in Camera View mode to check your view while you are working in Top View.
- 5 Drag the tip of the camera around in the Working window to check the view of your scene from all directions.
- 6 Once you have a good distribution of objects in a visually interesting scene, switch back to Camera View and do a quick test render.
- 7 After the render, make any required position changes.
- 8 Choose File > Document Setup and select QTVR Panorama.
This aspect ratio is optimized for use with Apple's Make QTVR Panorama tool, though many aspects will work.
The preferred aspect is 13:4. Width must be divisible by 96, and height must be divisible by 4. The QTVR Panorama option ensures that your image meets these criteria.
- 9 Click the triangle icon next to the Render controls and choose Select 360° Panorama from the menu.
- 10 Click the Render button to do a quick test render.

The panoramic render mode necessarily introduces some distortion into your image, and this may change the way you want your objects to appear.

- 11 Make any position changes you like.

When you do a panoramic render, your wireframe scene will bear little resemblance to the rendered scene. This is why you should work on your scene in standard Default mode, and switch to Panoramic rendering after everything is set up.

- 12 Choose File menu > Render To Disk. The Render to Disk dialog appears.
- 13 Leave the default settings.

The Output Size in Pixels was set by the QTVR Panorama option in the Document Setup dialog.

The Print Resolution defaults to 72dpi, which is the only acceptable setting for the screen-resolution VR movies; and the Output Size in Inches is extra information. You can, however, use these features to your benefit if you need to print out a 2D version of your VR scene.

- 14 Click the OK icon.
- 15 In the Save dialog, choose QuickTime VR, then click the Save button.
- 16 Specify the location and file name for your rendered QuickTime VR panorama.

To EXPORT A QuickTime VR PANORAMA:

- 1 Follow the steps above through step 11.
- 2 Click the Render button if you made any changes after your test render.
- 3 When the rendering is done, choose File menu > Export Image and choose QuickTime VR from the list.
- 4 Specify a location for the saved panorama, then click Save.

FURTHER VR EXPLORATION

This is a quick way to get started with simple, single-node QTVR movie-making. To create movies with other embedded nodes, or to get deeper into the world of QuickTime VR, contact Apple Computer.



16

USING BRYCE WITH OTHER APPLICATIONS

This chapter describes how Bryce works with other applications, the file formats that Bryce supports for both import and export, how to use Bryce to create Web-based content, and how you can communicate with other Bryce users on the Web.

The effects you add to a rendered image are considered post production. Post production includes things like compositing, filtering, and retouching the image in an image-editing application. Post-production can also include exporting to other applications. These aspects of post production are also covered in this chapter.

When you're working with animations, post production can include all of the still image operations, or it can include more advanced editing, like combining clips and adding sound effects.

WORKING WITH OTHER APPLICATIONS

Bryce lets you import images and objects from other applications. You can also export images and objects created in Bryce.

IMPORTING 2D IMAGES

Choose File menu > Open Image and select from one of the following image types:

- Windows Bitmap (.bmp)
- Enhanced Metafile (.emf)
- CompuServe® GIF (.gif)
- JPEG (.jpg)
- Photoshop® (.psd)
- Targa (.tga)
- TIFF (.tif)
- PICT (Mac only)

EXPORTING 2D IMAGES

You can export images to the file formats listed below:

- Windows Bitmap (.bmp)
- JPEG (.jpg)
- Photoshop (.psd)
- PICT (Mac only)
- TIFF (.tif)

Use one of the following commands to export files. If you need to conserve memory or plan to create a panorama movie, you must use the Render to Disk option.

- Choose File menu>Save Image As, then select a file type from the list. Not all file types are supported.
- Choose File menu>Export Image, then select a file type from the list. Bryce uses plug-

in filters for both the Export Image and Render to Disk options.

- Choose File menu > Render to Disk. This is the best choice if you have created a very large image, because it lets you set the DPI and saves memory.

Export Image and Render to Disk allow you to export to the following additional formats:

- HTML (.htm)
- QuickTime VR (.mov)

To learn more about QTVR, see “QuickTime VR Panorama Movies” on page 369.

IMPORTING AND EXPORTING 3D OBJECTS

Bryce can import objects saved to the following file formats.

- TrueSpace™ (.cob) Versions up to 4.0 are supported. Material properties are supported.
- VideoScape (.vsa) All versions are fully supported.
- VRML1 (.wrl) Imports all properties relevant to Bryce, including camera, light, and surface and material textures.
- LightWave™ (.lwo or .lws) Both objects and scenes are supported. The camera, lights, and all objects (with material information) are imported. Versions 6 and up are not supported.
- Heightfield (.hf) Used to import descriptions of heightfields (terrains).
- USGS DEM (.dem) All forms of DEM files are supported.
- USGS SDTS (.ddf) This format is the new USGS format which will replace DEM files.
- Portable Greyscale Map (.pgm) Used to import descriptions of heightfields (terrains).
- 3d Studio® Objects (.3ds)
- 3DMF (.3mf)
- AutoCad® (.dxf)

- Direct 3D (.x)
- Wavefront (.obj)
- WCS Elev (.elev)
- WorldToolKit® (.nff)

Bryce can export your final rendered object to most of the file formats listed above. You can also export a rendered object to the following file formats:

- Ray Dream Studio (.rds)
- RayShade (.hf)
- Infini-D 4.0 (.id4)

When you export a file, you save information, such as vertices, smoothed normals, UVs (texture coordinates), and texture maps.

Some file formats have limitations. For example, DXF doesn't support smooth normals or UVs. If the file format doesn't support texture embedding, each texture map is written as a separate image at the same location specified for the mesh file. The names of the images will start with the name you specified for the mesh file and include the name of the material. If UV information can't be written, two texture maps are exported: one for the top part, and one for the bottom.

When you export to a 2D format such as DEM or PGM, all the possible texture maps are generated.

To import an object:

- 1 Choose File menu>Import Object.
- 2 Choose the drive and folder where the file is stored.
- 3 Double-click the filename.

To export an object:

- 1 Select the object you want to export.
- 2 Choose File menu>Export Object.
- 3 Choose the drive and folder where you want to save the file.
- 4 Choose a file format.
- 5 Type a filename.

Post Production

Bryce is a 3D application that creates landscapes, it is not an image-editing program. As such, you won't find the image-enhancing capabilities of an image editor. For post production operations you'll need to use applications like Corel® Painter™, Corel PHOTO-PAINT® or Photoshop. You can use these applications to adjust colors, contrast or brightness. You can even paint in elements that were not in the original scene.

Rendered images can be saved to formats compatible with almost any image-editing application.

Compositing

Compositing is the process of pasting one image into another. For example, if you create a farm scene in Bryce and then create a mask for that scene, you could paste it into a scanned image of a tornado. With a little creativity you can make the farm appear as though it were about to be destroyed by the storm.

The shape of the foreground image is taken from a black-and-white image that contains the shape of your scene. This image is called a mask. You can generate a mask in Bryce by using the Mask Render mode.



Using compositing, you can take the scene you created in Bryce...



...render it as a mask, using Mask Render mode...



...and then use the image as a selection mask in a 2D image-editor. Once selected, you can place your Bryce scene into a 2D image.

To RENDER A SCENE AS A MASK:

- 1 Click the triangle next to the Render controls and choose Object Mask from the menu.
- 2 Choose File menu>Export and choose either BMP or PICT.

Using COREL® PAINTER™

The following compositing procedure uses Corel Painter as a post production application. The steps for Adobe Photoshop would be almost the same.

To composite using COREL PAINTER:

- 1 Render the scene normally using Perspective Render mode.
- 2 Save the image in a convenient location.
- 3 Select the objects you want masked.

- 4 Render the scene again, this time using Object Mask mode.
- 5 Save the mask image to the same location.
- 6 Open the Perspective Render image in Painter.
- 7 Choose Select menu>Load Selection.
- 8 In the dialog, select the Object Render image. Click OK.
Painter selects the objects in your scene.
- 9 Choose Edit menu>Copy.
- 10 Open the background image (the image you want to paste your Bryce scene into).
- 11 Choose Edit menu>Paste.
The selection is pasted into the image as a floater.
- 12 Position the floater where you want it.

Refer to the documentation that came with your image-editing application for more information on working with masks.

Adding Depth

Distance Mask Render mode produces an image that can be used as a distance mask in most image-editing applications. The Distance Render image contains grayscale representations of all the images in your scene. Objects closer to the camera appear black, while those furthest away appear white. The objects in between are various shades of gray depending on their distance from the camera.

This grayscale information can be used to create photographic depth of field effects. For example, if you take an image that has a lighthouse in the foreground and a fishing village in the background and render it using Distance Mask Render mode, you can take the image into Photoshop and create an image where the lighthouse is in sharp focus while the village is blurred.



You can add depth to your scene...



...by rendering it as a distance mask, using Distance Mask Render mode...



...and using an image-editing application to place the distance mask into the original image's alpha channel. Once the Distance Render is in the alpha channel, you can apply filters to create photographic depth of field.

To RENDER A SCENE AS A DISTANCE MASK:

- 1 Click the triangle next to the Render controls and choose Distance Mask from the menu.
- 2 Choose File menu>Export and choose PICT.
- 3 Choose the drive and folder where you want to save the file.

Using PHOTOSHOP

The following procedure uses Photoshop as a post production application. The steps for Corel Painter would be almost the same.

To CREATE DEPTH OF FIELD USING PHOTOSHOP:

- 1 Render the scene normally using Perspective Render mode.
- 2 Save the image in a convenient location.
- 3 Render the scene again, this time using Distance Mask Render mode.
- 4 Save the mask image to the same location.
- 5 Open the Perspective Render and the Distance Render images in Photoshop.
- 6 Place the Distance Render image into the alpha channel of the Perspective image.
- 7 Load the alpha channel as a selection.
- 8 Apply Gaussian Blur.

Objects close to you will appear sharp while objects farther away will become progressively more out of focus.

- You can also invert the selection and apply Motion Blur to the image. In this case, objects in the foreground would be motion blurred, and the background would be sharp, as if you took a picture from a moving car.
- You could determine very specifically which objects in your scene are in focus and which are not. Select the Distance Rendered alpha channel and remap the gray values in the Curves dialog in Photoshop. Remap black input to lighter output, and the gray value of the desired focal object to black.



You can change the focus of images by remapping the gray values in the alpha channel of your image.

PRINTING IMAGES

You can print rendered images directly from Bryce. If you need color separations, use an image-editing or pre-press application.

To print an image:

- 1 Choose File menu > Print, or press Command/Ctrl+P. The Print dialog appears.
- 2 Choose the options you want to use.

USING BRYCE ON THE WEB

If your computer is connected to the Internet, you can access the Internet while using Bryce5. You can communicate with other Bryce users, visit the Corel site, or view the latest technical support information.

ACCESSING THE WEB

Bryce now has a Links menu that will launch your default browser. You can update this list of links to add your own links and delete any default links you may not need.

In addition, you can export 2-D files to the Web using the Export Image or Render to Disk options on the File menu. You can export animations through the Render Animation feature.

To select a Web link:

- 1 Go to the Links Menu.
- 2 Click a Web link.

Bryce communicates with your browser to access the desired link.

MODIFYING A WEB LINKS MENU

You can modify your Web links menu using a text editor. It is a simple file that contains one line per link. Each line contains the name of the link, surrounded by quotes, a separating comma, and the URL in quotes.

To add or delete Web links:

- 1 Locate the Bryce 5 Links file in your Bryce folder.
- 2 Open the file in a text editor, such as WordPad, Notepad, or SimpleText.
Note that each line of the file contains the name of the link, in quotes, followed by the URL, also in quotes.
- 3 Delete the entire line for any links you want to remove from your list.
- 4 Enter the name of any new link, a comma, and any amount of space, followed by the URL of the new link in quotes.
- 5 If you want to add a dividing line to your menu, place an underline in quotes in both the link label and URL.
- 6 Save the file.

Your menu should now reflect your new links.

CREATE HTML IMAGES

Use Bryce to get your images on the Web! Bryce will export an HTML page with your rendered image, along with any hotspot links associated with the objects in your scene.

With the HTML dialog, you can set your Web page title, the server directory for the page (either your local hard disk or the Web host), the name of the JPEG file for the image, your e-mail address, and the Background URL.

Also, in the dialog are two sliders—one for the level of JPEG compression, and the other for how precise you wish the hotspot polygons to be. Bryce will then generate the HTML page and the JPEG image file for you, ready to be brought straight onto the Web.

TO CREATE AN HTML PAGE:

- 1 Select the objects that will become hotspot links.
- 2 Click the A icon to display the Object Attributes dialog.
- 3 Click the Linking Tab, and enter an URL in the Web Link box.
- 4 Select File menu>Render To Disk.
- 5 Select HTML files (.htm) as the type of file to export/render to disk and name the file.
- 6 Fill in the settings in the HTML Export dialog.

Your image is exported in JPEG format.

QuickTime MOVIES

Bryce creates pre-flattened QuickTime movies that are ready to go wherever you wish to take them, be it the Internet or your friend's computer.

TO CREATE A QuickTime MOVIE:

- 1 Create an animation in Bryce.
- 2 Select File menu>Render Animation.

- 3 Click the triangle icon beside Output module, and select QuickTime Movie.
- 4 Click Edit, and adjust the details of the animation.
- 5 Click Set, and choose the drive and folder where you want to save the file.
- 6 Type a filename.

QuickTime VR PANORAMA MOVIES

Bryce can now generate QuickTime VR Panorama Movies directly. Panorama movies are movies in which you can interactively shift your viewing angle.

You can generate a QTVR movie from Export Image or Render To Disk. When you use Render To Disk, you can optionally select 90 degree counterclockwise rotation for QTVR, to save memory.

For information about generating QTVR movies, refer to "QuickTime VR" on page361.



17

Glossary

2D projection Your 3D scene must be interpreted as a 2D projection; that's how it is translated to your 2D screen! Pretend your 3D scene is a drawing on a (2D) piece of paper, which is in front of your camera lens; you have control over the right/left up/down position of the paper (Pan controls), and over the scale of the drawing (Zoom/Scale tools). 2D Projection values are an important factor in defining a View for your scene.

3D transformation This is a term that refers to any operation relating to the size, rotation, and position of any object. There are in fact other types of 3D transformations that are possible in 3D space, such as deformations, sweeps, and lathing; but Bryce is not a modeler, and supports only the basic three: size, rotation, and position.

3DMF 3D MetaFile format from Apple for exchanging 3D geometry between applications.

absolute coordinates Values which express an absolute location, rotation, or size, whether they are location coordinates, degrees of rotation, or units of measure.

additive mode A color blending algorithm which adds the brightness value of colors from one item to the brightness values of another.

algorithm A finite step-by-step problem-solving procedure.

aliasing A visual artifact caused by low resolution sampling that can cause hard edges or areas of high frequency in an image to look jagged (often referred to as “jaggies”). See “antialiasing.”

alpha channel A separate grayscale channel accompanying any PICT/BMP file that can determine which areas of the PICT/BMP will be visible in the final image and which will not. Typically, white areas in the alpha channel describe the areas in the corresponding image that will be visible, while black areas in the alpha channel describe the areas in the corresponding image that will not be visible. Also referred to as a mask. In the absence of an alpha channel, Bryce can use the luminance values of any 2D PICT or 3D solid texture as alpha information.

altitude A measurement of height. In Bryce, many textures will change their behavior based on altitude.

ambient Light that has no point of origin or specific direction, and is presumed to strike every point on every object with equal intensity. Since it is not affected by other environmental light, it tends to affect objects in shadow, and can make objects visible even with no specific light source.

amplitude In Bryce, this refers to the intensity of the cloud definition. Increasing the amplitude will make cloud contours harder, while decreasing it will result in softer-edged, more diffuse cloud formations.

antialiasing The process of eliminating aliasing by higher resolution sampling, so that hard but jagged edges appear smooth and clean.

aspect ratio The relationship between the width and height of your document, expressed in pixels as a width to height ratio.

auto-update A feature in the Sky & Fog palette and Nano-preview which will automatically update your changes into your rendered scene or Nano-preview, respectively.

banking Camera rotation around its Z axis; kind of a left/right tilt. Also known as roll, it creates the illusion that your horizon is tilted.

batch rendering A process that will allow you to automate the rendering of multiple scenes. Just drag and drop a group of scene files on the Bryce application icon, and Bryce will do the rest.

bitmap Literally, a “map of bits.” Your screen is comprised of pixels, and each one of those pixels expresses a level of color, whether it is one bit (black and white) or 24-bit (millions of colors). Your image, when rendered, can be thought of as a pixel-by-pixel map of color, hence the term “Bitmap”.

boolean rendering A rendering process wherein either the space taken up by “negative” objects is subtracted from “positive” objects, yielding an object with portions removed; or two or more objects are combined to form a composite object combining the mass and dimensions of all contributing objects.

boolean A fancy word that is used to describe a system where there are two possible states: On/Off, Yes/No, 0/1, True/False, and so on. With respect to Bryce rendering, a Boolean attribute such as Negative or Intersect will determine whether a particular part of a group of objects will be Rendered/Not Rendered.

Bryce units of measure An arbitrary system of measurement for 3D objects in Bryce 3D. Most Bryce objects when they are created are a default size of 2048x2048x2048 Bryce units.

bump mapping A process that interprets changes in an object's surface luminance or color values and, without actually affecting the object's geometry, expresses them as perturbations on the object's surface.

camera space A method for representing objects in 3D space. It uses a set of Cartesian coordinates which are relative to your camera.

camera A metaphorical "tool" for viewing areas in a scene. The metaphor refers to the conical projection of the scene onto a 2 dimensional plane along a specific direction.

center scaling The ability to perform resizing or rotating operations on an object based on the object's center, rather than an alternate point, such as its base.

CMYK color A well known subtractive color standard widely used in the print industry. CMY color models blend Cyan, Magenta, and Yellow to approximate colors for print; almost always used with a fourth ink, black (K), to compensate for ink impurities.

conversion The process of changing an object of one type into an object of another type. Use the little arrow in the Edit palette...

deformation A special form of 3D transformation which will deform an object's geometry, creating bulges, twists, bends, and more. Bryce 3D does not support this kind of transformation; but you can certainly import deformed objects from other modeling applications via the Import DXF and 3DMF feature in Bryce.

depth cueing The effect we use to create the appearance that wireframes far away are dimmer than wireframes closer to the camera. This effect is adjustable.

derivative objects Most primitives available in the Create palette also have a few derivative objects as well. For instance, the Sphere is accompanied by an Ellipsoid and a Squashed Sphere; both are considered to be Spheres by Bryce, but they have had some post-processing applied to change their sizes.

diffuse Light that is evenly reflected from an object's surface, visible regardless of the angle from which it is viewed. Diffuse is associated with matte objects.

document resolution The actual size of your working document area, expressed in pixels. When your Render Resolution is set to 1:1, the Render resolution is the same.

DXF Originally developed for use with AutoCad[®], this is the most common 3D file exchange format.

edit Any action performed on an object after its initial creation. Includes moving, resizing, rotating, copying, assigning textures, pasting, and more.

family A kind of logical association, assigning a Family attribute to a set of objects allows you to select and display sets of objects based on an assignable wireframe color and associated family name. This way, objects which share some characteristic such as distance, structure, material, or other, can be easily seen, selected, soloed, and so on.

field of view Field of View values describe the range, from 1 to 180°, which your camera is allowed to take in.

frequency A measurement of the number of times certain textural characteristics repeat themselves within a fixed area.

gel A texture or picture which is applied to a light and treated as a transparency or slide, enabling the light to project colors, textures, or images onto objects in your scene.

gradient A smooth progression of two or more colors.

gradient lights A light object that colors surfaces differently depending on the distance of the surface from the light object.

grayscale-to-height mapping A process that interprets a grayscale range from black to white and expresses that range as height, from low to high.

group Grouping, a kind of spatial association, allows a set of objects to be treated as one. To achieve Boolean rendering effects, objects must be grouped.

HLS color An alternative color model: Hue, Lightness, and Saturation.

HSV color An alternative color model: Hue, Saturation, and Value.

illumination In Bryce 3D, any property or characteristic related to how an object responds to light. This includes Ambient, Color, Diffuse, Reflectivity, Refraction, Specular, and Transmittivity.

image resolution Since Bryce renders bitmaps at 72dpi, the only image resolution you need to determine is the height to width ratio of your image.

infinite plane A two dimensional surface that extends infinitely along the X and Z axes. Bryce 3D's Ground, Cloud, and Water Planes are all infinite planes, though they exhibit different textural properties and are placed in the scene at different altitudes.

landing Dropping an object straight down onto the object directly beneath it. Usually used to "land" an object on the ground.

link to view A Bryce feature which locks the sun's position to the camera position. This way you can use the sun control to set your sun position, and you will not lose that position if you move the camera.

location An object's position in 3D space. Synonymous with position and offset.

mapping The process of interpreting data input of one kind and expressing it as another. See Bump Mapping, Grayscale-To-Height Mapping, Pict Mapping, and Texture Mapping.

marquee selection Marquee is a noun which refers to a tool, in many applications, which will create a selection area; it can also be used to refer to the selection itself. Bryce has no marquee tool per se, but you can click and drag in the wireframe window to marquee a selection (here the term is used as a verb), and you can click and drag in the rendered image to marquee a selection for discrete rendering.

material In Bryce 3D, the sum of up to four textural elements, either 3D procedural or 2D picture-based, used to drive various effect channels, plus post processing, used as a surface property for Bryce objects.

materials channel The rows in the Materials Grid, grouped as Light, Effect, and Color; can be driven independently or by Texture Components.

materials grid The gameboard-like area in the Materials Lab where Texture Components drive parameters in the various Channels in the Grid to make a Material.

matrix The term is used only in the Bryce Edit menu, for the Copy/Paste Matrix commands. When you use these commands, you are copying and pasting an object's position, rotation, and size; you are not copying size, rotation, or position alone, but the matrix of all coordinates, hence the name.

memory dots This feature, available in the Control palette for use with Views, and in the Sky & Fog palette, allows you to simply click on a Memory Dot to save the state of the parameters to which it pertains.

mesh Sometimes known as polyhedron. Used in reference to imported geometry as well as Bryce's internally created Stone objects. Similar to Polygon, but polygonal faces have been diagonally split, or triangulated.

metaballs Spheres that blend into each other based on proximity. The closer two Metaballs are to each other, the more their shape merges together. Metaballs can be used to create fluid shapes that are otherwise time-consuming or even impossible to create using primitives and Boolean operations.

nano-editor The Nano Editor is a small version of your wireframe window, which you can use to edit your scene quickly.

nano-preview A small preview of an object or scene. The Nano-preview window is at the top of the Control Palette.

network rendering A special rendering mode that sends sections of a render to multiple computers. This reduces the amount of time required to render a complex scene without sacrificing the complexity of the scene or the quality of the final rendered image or animation.

network render server A computer connected to a TCP/IP network that controls the other machines on the network, sending them sections to be rendered and reassembling all of the rendered sections into the final image or animation.

network render client A computer connected to a TCP/IP network that receives and renders sections of an image, and then sends the rendered sections back to the network render server.

object space A method for representing objects in 3D space. It uses a set of Cartesian coordinates which are relative to a given object.

object type Though Bryce creates and imports many kinds of objects, for the purpose of selections and conversions it must sort these objects into types. These types can be clearly seen in the Conversion option and in the Edit palette. Cubes and their derivatives are all of the Cube type; Cloud, Water, and Ground planes are all of the Infinite Plane type; Pict objects and 2D Faces are all of the 2D Face type; all imported objects are of the mesh type.

offset An object's position in 3D space. Synonymous with position and location.

opacity The degree to which light cannot pass through an object. In Bryce, the term primarily refers to the opaque portions of alpha-channels.

orientation An object's orientation in 3D space, expressed in degrees; synonymous with rotation.

orthogonal A special projection of your scene which has no perspective distortion. Kind of a perspective-free drafting board view, used for precise alignments. All Views with the exception of the Camera View are Orthogonal. The term can be used interchangeably with the term orthographic.

output resolution Available in the Export Render dialog, you can set the print resolution of the resulting rendered image expressed in dots per inch.

parallel light A light which cast rays that are perfectly parallel to one another.

patch rendering A technique you can use in Bryce 3D: select a specific area, or patch, of your image for further rendering. Useful to examine areas for detail before doing a final render, or for re-

rendering specific areas after making a change, thereby avoiding having to re-render your entire image.

pict mapping A process that interprets a 2-dimensional Pict and expresses it as the surface of a 3-dimensional object, according to a specified algorithm.

pitch Camera rotation around its X axis; kind of a tilt forward or back.

plop-render Just a cute name for our way of representing a marquee selection of your rendered image. Selections appear to “plop” forward, with attendant drop shadows and rendering controls. This feature can be enabled, disabled, or hidden, as you wish.

polygon All 3D objects in Bryce 3D are built from multiple-sided (in Bryce, we use 4 sides) geometric surfaces, and are therefore inherently polygonal in nature.

primary rays The quantity of virtual rays of light that are initially “shot” into the Bryce scene.

primitive A basic geometric form, such as a cube or sphere, used as a basis for constructing compound 3D objects such as buildings, rocket ships, or snowmen.

primitives Like primary colors, Primitives are the primary objects in Bryce. Spheres, cubes, cylinders, pyramids, cones, disks, squares, and toruses are all primitives.

procedural objects Procedural objects are object that require special constructions or “procedures” to create them. Procedures can include operations such as preassignment of materials, randomization of internal parameters or assignment of light properties. For example, terrains.

radial light A light which casts rays equally in all directions.

ray hits The total number of times all rays strike objects in your scene. Note: The total of Ray Hits and Misses is not equal to the total of Primary and Shadow rays because secondary rays are not quantified in the Render Report.

ray misses. The total number of rays that are fired, but strike no objects in your scene. Note: The total of Ray Hits and Misses is not equal to the total of Primary and Shadow rays because secondary rays are not quantified in the Render Report.

raytracing An image synthesis technique by which a virtual beam of light is projected from a virtual camera into a 3D scene in order to evaluate shading and visibility. The virtual beam may be absorbed, reflected, or otherwise affected to some degree by every object it strikes. For instance, if it hits your sky, then a blue sky color ends up on that portion of your virtual “film”, your image. In this way, a final color is determined for each pixel in your image.

reflectivity The degree to which an object bounces light back from its surfaces.

refraction As a light wave passes from air through another medium such as water or thick glass, it seems to bend or turn to a certain degree. This phenomenon is known as refraction, and the degree to which light bends or turns in these situations is controlled by the Refraction channel in the Materials Lab.

relative coordinates Values which express location, orientation, or size relative to the current location, orientation or size.

render The complex process of building a 2-dimensional bitmapped image from all the information contained in your 3-dimensional wireframe scene.

render resolution The size of your rendered image, expressed in pixels, or as a multiple of your Document Resolution. The implication here is that your rendered image can be larger or smaller than your Document Resolution.

replicate While Duplicate will create a copy of your selected object, Replicate will create a copy of the object and the last 3D transformations applied. If you create an object, move it up a bit and rotate it a bit, selecting Replicate will create a copy, move it and rotate it for you; Multi-replicate will do the same with multiple copies in one step.

roll Camera rotation around its Z axis; kind of a left/right tilt. Also known as banking, it creates the illusion that your horizon is tilted.

rotation An object's rotation in 3D space, expressed in degrees; synonymous with orientation.

scale Values that express the space an object occupies; synonymous with Size, though Size implies an absolute space.

scene a) The complete content of your Bryce world; b) The two-dimensional screen projection of your 3D scene; c) The file that Bryce saves, containing all information regarding your landscape.

secondary rays When a primary virtual light ray strikes an object, if that object is reflective or transparent, another secondary ray is fired from that location (either bounced, if reflective, or bent, if transparent/refracted) to continue through the scene. This process is repeated up to six times, to find a home for the ray, and therefore a final color for a pixel in your scene. Secondary rays are not quantified in the Render Report.

shadow rays Once a primary or secondary virtual light ray has found a final resting place, it must determine whether or not to create a shadow behind the object. To do so, another ray is fired from that location, and this is a shadow ray.

size Values that express the space an object occupies; synonymous with Scale, though Scale implies a relative size.

sky dome A secondary environmental ambient light, used to create a color cast in a scene where there is little visible global light.

smoothing Imported objects consist of polyhedral faces, which, when rendered, appear quite chunky. This is not, in most cases, desirable. Use the smoothing command to eliminate this chunkiness. You can set a threshold angle for smoothing as well.

snap to A special form of 3D Transformation changes the selected object's position based on the Snap To. command you select. These commands are located in the Edit palette, in the Alignment Options menu.

solid texture A three-dimensional mathematical description of an object's textural characteristics. Often referred to as procedural texture.

specular The "highlight" of any object with a shiny surface; light that reflects non-uniformly in specific directions depending on the surface roughness. "Specular highlight" refers to the point where specular reflection is most pronounced.

spotlight A light which casts rays in a cone shaped spread; often used to create the classic "Hollywood spotlight" effect.

square spotlight Similar to the SpotLight, but casts rays in a pyramid-shaped spread; think of it as a slide projector.

symmetrical lattice A procedural Bryce Terrain object which has another Terrain mirrored at the base.

terrain An object used in Bryce as the basis for mountains, islands, plateaus, and other landscape objects.

Terrain Canvas The area in the Terrain Editor onto which you paint and apply effects. Terrain data can be rendered at many levels of detail, from 16x16 to 1024x1024. This resolution does not refer to the wireframe that is used to represent the terrain, but instead to the grayscale data used to determine the internal level of detail used to generate the terrain. Terrains with lower resolutions will appear chunky, and will render very quickly; use these for terrains that are far in the background or where detail is not so important. Terrains with higher resolutions will show increasing levels of detail, and will take much longer to render; use these for foreground terrains, or in other cases where detail is important.

terrain resolution Terrain geometry can be rendered at several levels of detail. At very low settings, you may see geometric “facets” in your terrains, even with “smooth surfaces” selected. In this case, increase your terrain resolution. Low resolution rendering is often best for items in the far background, where detail is not so important.

texture component a part of an object’s material. Texture Components, which can either be a 2D Picture or 3D Texture.

texture mapping A process of applying detail to a surface without actually affecting the object’s geometry. Values from the texture can determine or affect any surface characteristic, including color, reflectivity, transparency, or bumpiness.

torus A Bryce primitive that looks like a donut.

transparency The measure of an object’s ability to transmit light through its surfaces. Also referred to as transmittivity.

triangulation The process of splitting up geometric faces into triangles for greater flexibility.

unity The state a Bryce object is in when it is first created, or just after the Unity button has been pressed; positioned within a “cube” of fixed size in an invisible 3D grid, with no rotation applied.

view The sum of camera position in 3D space, plus 2D Projection pan and scale values.

wireframe A mesh representation of a 3D object.

wireframe resolution Your onscreen wireframe objects can be displayed at various levels of detail; this display resolution can be set discreetly for static, selected, and moving wireframes. This resolution has no relevance to document, render, or output resolution.

world space A method for representing objects in 3D space. It uses a fixed, or absolute, set of arbitrarily determined Cartesian coordinates.

yaw Camera rotation around its Y axis; kind of turning to look right or left.

INDEX

NUMERICS

- 2D faces 65
- 2D projection
 - defined 371
- 3D space in Bryce
 - camera space 203
 - object space 202
 - world space 202
- 3D transformation
 - defined 371
- 3D Transformations dialog 211, 213, 215
 - aligning 220

A

- Absolute coordinates 204
 - defined 371
- Accelerator card 71
- Accepting changes 32
- Accessing the Web 368
- Add Frame button 328
- Add Key Frame button 330
- Adding
 - clouds 253
 - depth 366
 - objects to a selection 66
 - pictures to Library 86
 - preset objects 75
 - preset skies 270
- Additive mode
 - defined 371
- Adjusting
 - render brush size 304
- Advanced Display palette 11
- Advanced Motion Lab
 - button 334
 - hierarchy list area 334
 - overview 13, 334
 - preview area 338
 - sequencer 335
 - Time Mapping Curve editor 337

- Aiming the Camera 298
- Algorithm
 - defined 372
- Aliasing
 - defined 372
- Align option 237
- Align tool 207, 217
- Aligning objects 216
 - along motion paths 237
 - landing 218
 - numerically 220
 - snap to options 218
 - using the align tool 217
 - using the grid 216
- Alpha channel
 - defined 84
 - images
 - adding information 86
 - creating 87
 - pasting 87
 - viewing 85
 - inverting 83, 88
- Alpha channels
 - defined 372
 - in Pict objects 82
 - materials 133
- Altitude
 - clouds 257
 - defined 372
- Ambience 135
 - defined 372
 - setting using textures 135
- Ambient color
 - setting using texture 136
 - skies 248
- Amplitude
 - clouds 257
 - defined 372
- Animating
 - between materials 353
 - camera 346

- clouds 355
- director's view 347
- editing object attributes 236
- environmental effects 356
- lights 285
- material channel values 351
- materials 343, 350
- skies 343, 354
- sky and fog settings 355
- sun/moon 356
- techniques 343
- terrain geometery 358
- terrains 343, 357
- texture components 352
- using orthogonal views 346
- Animation
 - advanced motion lab 13
 - previewing 354, 360
 - process 320
 - rendering 311
 - tab 68
 - terrains 96
- Animation controls 11, 322
 - Advanced Motion Lab button 334
 - Keyframe controls 328
 - options 330
 - preview controls 327
 - terrain editor 96
 - Time Dots 324
 - Timeline 323
- AntiAliasing
 - defined 372
 - rendering 301
- Application
 - launch state 25
- Area render 304
- Arranging
 - objects 33, 201
- Aspect ratio
 - defined 372
 - documents 18
 - preset values 18
- Atmosphere
 - color perspective 252
- Atmosphere Off 246
- Atmosphere tab
 - Sky Lab 267, 270
- Attributes
 - command 68
 - editing 74
 - skies 246
 - Wireframe mode 27
- Auto Update 20
- Auto-key 330
- Auto-Update
 - defined 372
- AVI files 311
- B**
- Back view 21
- Background
 - color 29
 - texture 28
- Backgrounds
 - paper texture 28
 - window 28
- Banking
 - controls 295
 - defined 372
- Base Density 143
 - setting using a texture 143
- Base Height
 - Sky Lab 249
- Basic Noise
 - terrain effect 102
- Basic tools
 - basic noise 102
 - gaussian edges 101
 - height noise 102
 - raise/lower 100
 - round edges 101
 - sharpening 100
 - slope noise 102
 - smoothing 100
 - square edges 101
 - terrains 100
- Batch Rendering 315
 - defined 372
- Behaviors
 - paintbrush 106
- Bitmap
 - defined 372
 - display mode 26
 - preview mode 71
 - saving 25
- Bitmap file format 364
- Blending
 - fog color 249
 - haze color 252
 - pictures 112
- Blob Maker
 - terrain effect 104
- Blurry reflections 306
- Blurry transmissions 306
- BMP file format 364
- Boolean
 - compound 74
 - defined 372
 - intersection 73
 - neutral 72
 - operations 73
 - rendering,defined 372
 - subtraction 73
 - union 73
- Booleans
 - editing attributes 233
 - intersect 234
 - negative 234
 - Nuetral 233
 - positive 234
- Bottom view 21
- Bounding Box preview mode 70
- Boxes
 - displaying objects as 23
- Brightness
 - moon 265
- Bryce
 - interface 29, 32
 - setting up windows 25
- Bryce 3D overview 17
- Bryce and 3D space
 - coordinate systems 204
- Bryce Lightning
 - installing 313
 - IP address 313
 - uninstalling 313
- Bryce units

- defined 372
- Bubble Ridges
 - terrain effect 106
- Building Textures 197
- Bump Height 138
- Bump mapping
 - defined 373
- C**
- Camera
 - 2D Projection dialog 296
 - aiming 298
 - animating 346
 - banking 295
 - controls 9
 - defined 373
 - field of view 295
 - hiding 289
 - linking 348
 - linking to clouds 259
 - linking to sun 262
 - locking 289
 - modes 291
 - orbits 349
 - origin point 297
 - positioning 32, 293
 - positioning controls 9
 - positioning manually 297
 - positioning origin point 296
 - rotating 293
 - saving positions 299
 - setting properties 289
 - tracking 348
 - trajectory 347
- Camera controls 293
 - options 294
 - X-Y 293
 - X-Z 293
 - Y-Z 293
- Camera Cross controls
 - options 294
- Camera modes 291
 - center to selection 292
 - choosing 293
 - free 292
 - trackball mode 291
 - tripod mode 292
- Camera space 203
 - defined 373
- Camera trackball 293
- Camera view 20, 288
 - banking 295
 - field of view 295
 - overview 289
 - positioning numerically 296
 - swapping with Director's view 290
- Cancel and OK 32
- Canvas
 - blending with filter 110
 - mapping colors to 113
- Center scaling
 - defined 373
- Center Scene option 294
- Center Selection 294
- Center to Selection Mode 292
- Channels
 - alpha 84
 - animating 351
 - materials 128
- Checkmark icon 32
- Clipping
 - bracket 114
 - moving bracket 115
 - resetting 114
 - setting range 114
 - terrains 114
- Closing
 - files 25
- Cloud Coverage 256
- Cloud plane tool 78
- Cloud planes 78
- Cloud tab
 - environmental attributes 254
 - Sky Lab 254
- Clouds 253
 - adding 253
 - altitude 257
 - amplitude 257
 - animating 355
 - coverage 256
 - cumulus 254
 - editing texture 254
 - fixed plane 259
 - frequency 257
 - linking to camera view 259
 - stratus 254
- CMYK color
 - defined 373
- COB file format 364
- Collapsing
 - object hierarchies 223
- Color
 - adding to terrains 113
 - ambient skies 248
 - blending fog 249
 - blending haze 252
 - editing light 279
 - fog 249
 - haze 251
 - mapping to canvas 113
 - selecting background 29
 - sky dome 257
 - sun 263
 - switching to grayscale 114
- Color blending modes 175
 - altitude 177
 - banded 176
 - blue or saturation 175
 - earth map 176
 - green or light 175
 - interferences 176
 - interpol + interferences 177
 - linear interpol 2 176
 - linear interpol 3 176
 - none 175
 - orient 177
 - perturbed 176
 - randomized 176
 - red or hue 175
 - slope 177
 - spline interpol 175
 - spline with snow 177
- Color channels 129
 - ambient color 136
 - diffuse color 134
 - specular color 137
 - transparent color 140

- Color Perspective 252
 - Color/Grayscale toggle 114
 - Combining texture components 192
 - Components
 - animating 352
 - colors 174
 - materials 132, 144
 - textures 174
 - Compositing 365
 - Compound
 - Boolean 74
 - CompuServe GIF file format 364
 - Cones
 - creating 65
 - Constrain Proportions button 18
 - Control handles 69
 - Control palette
 - View Control 9
 - Control points 211, 215
 - rotation 213
 - Controls
 - animation 11, 322
 - Animation Preview 327
 - camera 9
 - displaying information 10
 - Keyframe controls 328
 - positioning 9
 - rendering 10
 - Time Dots 324
 - view 9
 - Conventions
 - user manual 6
 - Conversion
 - defined 373
 - Converting
 - objects 239
 - paths 89
 - Coordinate systems 204
 - absolute coordinates 204
 - definition coordinates 205
 - relative coordinates 206
 - Copying
 - Alpha channel information 87
 - pictures 86, 112
 - RGB information 87
 - Corel support and services 2
 - Coverage
 - clouds 256
 - Create light tools 277
 - Create palette 10
 - Picture Library and 85
 - Create Path command 89
 - Creating
 - 2D faces 65
 - alpha channel images 87
 - cones 65
 - cubes 65
 - cylinders 65
 - derivative primitives 65
 - discs 65
 - documents 18
 - HTML pages 369
 - infinite planes 77
 - lights 275
 - materials 13
 - metaballs 81
 - object hierarchies 221
 - orbits 349
 - Pict objects 81
 - primitives 65
 - pyramids 65
 - QuickTime movies 369
 - radial lights 277
 - RGB images 87
 - scenes 18
 - spheres 65
 - spotlights 277
 - square spotlights 277
 - stones 80
 - terrains 12, 92, 97
 - textures 197
 - toruses 65
 - VR panoramas 361
 - Cross Ridges
 - terrain effect 105
 - Cross Ridges 2
 - terrain effect 105
 - Cubes
 - creating 65
 - Cumulus
 - adding 254
 - clouds 254
 - Cursor 69
 - Customer Service 2
 - Cylinders
 - creating 65
- ## D
- Dampen
 - terrain effect 103
 - Darker Sky 245
 - Day/Night toggle 261
 - Deep texture editor 196
 - blend modes 192
 - building textures 197
 - component elements 174
 - component outputs 172
 - component previews 198
 - drag and drop 198
 - randomizing components 199
 - using 197
 - Definition coordinates 205
 - Deformation
 - defined 373
 - Delete Key button 329
 - Deleting
 - objects from a selection 66
 - pictures 87
 - Preset objects 76
 - preset skies 270
 - DEM 364
 - Depth
 - adding 366
 - Depth Cue 27
 - defined 373
 - icon 28
 - Depth of field 306
 - Derivative primitives 65
 - defined 373
 - Deselect All command 66
 - DFF file format 364
 - Dialogs, displaying 12
 - Diffuse color 134
 - Diffusion 133
 - defined 373
 - Director's view 288
 - animating 347

- banking 295
- field of view 295
- overview 290
- positioning numerically 296
- swapping with camera view 290
- Disabling
 - sun 263
- Discs
 - creating 65
- Display
 - changing 22
- Display Mode tool 26
- Display modes
 - bitmap 26
 - Flat Shaded Preview 27
 - setting 26
 - switching 26
 - wireframe 26
 - wireframe/bitmap 26
- Displaying
 - dialogs 12
 - interface information 10
 - object statistics 10
 - objects as boxes 23
 - objects as wireframes 23
 - palettes 12, 29
 - pictures 85
 - rendered image information 10
 - scenes 19
 - Selection palette 66
 - show as box 234
 - submenus 12
 - VCR Controls 67
- Distance render 366
- Do not align option 237
- Document resolutions
 - defined 373
- Documents
 - aspect ratio 18
 - creating 18
 - preset resolutions 18
 - resolution 18
- DXF file format
 - defined 373
- DXF objects
 - smoothing 238

E

- Edge softness 143
- Edit Attributes command 74, 230
- Edit button 239
- Edit Gradient Dialog 281
- Edit palette 11
- Editing
 - attributes 74
 - cloud textures 254
 - imported meshes 238
 - materials 13
 - stones 238
 - terrains 12
 - toruses 237
 - trees 119
 - visible light material 284
- Editing objects 229
 - animation attributes 236
 - attributes 230
 - boolean attributes 233
 - converting 239
 - display attributes 234
 - icon 233
 - linking attributes 236
 - names 233
 - restoring 230
 - torus attributes 237
 - tracking attributes 236
 - transformations 235
- Editor
 - terrain 93
- Effects
 - applying locally 106
 - elevation tools 99
 - eroding 97
 - image filtering 102
 - removing locally 106
- Elevation
 - basic tools 100
 - image filtering effects 102
 - painting 106
 - tools 99
 - using tools 99
- EMF file format 364
- Enhanced Metafile file format 364

- Environmental attributes
 - Sky Lab 243
- Environmental effects 266
 - animating 356
 - rainbows 267
 - stars 268
 - sun/moon illusion 267
 - sun/moon rings 266
- Environments
 - adding clouds 253
 - effects 266
 - rainbows 267
 - Sky Lab 243
 - stars 268
 - sun 260
 - sun/moon illusions 267
 - sun/moon rings 266
- Equalize
 - terrain effect 103
- Erasing
 - Marker Pen lines 24
- Eroding
 - locally 107
 - terrains 97
- Exiting dialog boxes 32
- Expanding
 - object hierarchies 223
- Exporting
 - images 364
 - mesh objects 239
 - Preset objects 76
 - sky presets 271
 - terrains 115
- exporting 239
- Eye Level Camera 294
- F**
- Faces
 - creating 65
- Falloff 280
- Families 226
 - defined 373
 - icon 231
 - tool 67
- Fast preview 310
- Fast render strategies 315

- patch rendering 316
- Field of View 295
 - defined 373
- Files
 - closing 25
 - opening 18
 - saving 25
- Filtering 186
 - absolute— $\text{abs}(aX + b)$ 188
 - altitude minus slope— $Xb + a$ (altitude-slope) 189
 - altitude— $X(a * \text{altitude} + b)$ 190
 - applying changes to preview 110
 - blending with canvas 110
 - choosing filter 187
 - clip $aX + b$ 189
 - editing filter 187
 - gaussian— $(a(X + b))$ 189
 - how it works 107
 - none 188
 - orientation— $X(a * \text{orientation} + b)$ 191
 - quantize 188
 - saw wave 188
 - sine wave— $\sin(aX) + b$ 188
 - slope— $X(a * \text{slope} + b)$ 190
 - smooth clip 191
 - snow puddles 191
 - tab 109
 - terrains 107
 - xpower— $(X^{\text{PWR}} a) + b$ 189
- Filtering Graph
 - altering 109
 - softening 110
 - terrains 109
- Filtering tab 109
 - graph 109
 - presets 110
- Fixed cloud plane 259
- Flat Shaded Preview display 27
- Flipping objects 210
- Fly-around view 23
- Fly-around view icon 23
- Fog
 - adding 248
 - attributes 248
 - color 249
 - height 249
 - linking to sun 250
 - localized 250
 - setting amount 249
- Fog color
 - blending 249
- Fractal
 - terrain effect 99
- Free Mode 292
- Frequency
 - clouds 257
 - defined 373
- Front view 21
- Full Scene mode 20
- Fuzzy Factor 143
- G**
 - Gaussian Edges
 - terrain effect 101
 - Gels 83, 284
 - defined 373
 - using texture 285
 - General tab 68
 - Geometric paths
 - converting to 89
 - linking options 225
 - linking to objects 89
 - Geometry
 - animating 358
 - Geometry effects
 - blob maker 104
 - bubble ridges 106
 - cross ridges 105
 - cross rodges 2 105
 - raise edges 105
 - relief noise 104
 - subplateaus 105
 - GIF file format 364
 - Global texture changes 194
 - colors 195
 - filtering 196
 - noise 195
 - phase 195
 - Glossary 371
 - Gradient
 - defined 374
 - Gradient lights 280
 - creating 280
 - defined 374
 - editing 281
 - offset 281
 - range 281
 - transparency 282
 - Gradients
 - for terrains 113
 - Graph
 - filtering 109
 - Gray levels
 - darkening 107
 - lightening 107
 - painting 106
 - Grayscale
 - switching to color 114
 - to-height mapping, defined 374
 - Grid 216
 - units 216
 - Ground plane tool 77
 - Ground planes 77
 - Grouping objects 221, 225
 - defined 374
 - families 226
 - icon 232
 - ungroup icon 232
 - Groups
 - selecting objects 66
- H**
 - Handles 69
 - Haze
 - adding 248
 - attributes 251
 - color 251
 - intensity 251
 - linking to Sun 252
 - Haze color
 - blending 252
 - Height Noise
 - terrain effect 102
 - Heightfield file format 364
 - HF file format 364

- Hidden objects 234
 - selecting 66
- Hiding
 - interface 29
 - palettes 29
- Hierarchies 221
 - collapsing 223
 - expanding 223
 - families 226
 - grouping 225
 - linking 223
 - structure 221
 - viewing 222
- Hierarchy List 334
- HLS color
 - defined 374
- Horizon
 - sun/moon illusion 267
- HSV color
 - defined 374
- HTML file format 364, 369
- HTML images
 - creating 369
- I**
- Icons
 - editing objects 233
 - families 231
 - grouping 232
 - landing objects 233
 - material 232
 - object attributes 230
 - tracking 231
 - ungroup 232
- ID4 file format 365
- Illumination
 - defined 374
- Image filtering effects 102
 - dampen 103
 - equalize 103
 - mosiac 103
 - mounds 103
 - posterize 103
 - sawtooth 104
 - spikes 102
 - subcontours 104

- Image resolution
 - defined 374
- Images
 - compositing 365
 - exporting 364
 - importing 364
 - printing 368
 - rendered information 10
 - working with rendered 316
- Imported objects
 - smoothing 238
- Importing
 - images 364
 - objects 89, 364
 - Preset objects 76
 - sky presets 271
- Infini-D 4.0 file format 365
- Infinite planes 77
 - defined 374
- Infinite slabs 79
- Information
 - adding to pictures 86
 - interface 10
 - objects 10
 - rendered images 10
- Installing 3
 - Macintosh 4
 - uninstalling for Macintosh 4
 - uninstalling for Windows 3
 - Windows 3
- Intensity
 - light 279
 - setting haze 251
 - shadows 247
- Interactive
 - repositioning 215
 - resizing 211
 - rotation 213
- Interface
 - Bryce 32
 - hiding 29
 - information 10
- Intersecting
 - objects 74
- Intersection
 - boolean 73, 234

- Invert button 88
- Inverting
 - Alpha channel 88
 - alpha channel 83
 - terrains 97
- J**
- JPEG file format 364
- JPG file format 364
- K**
- Keyframes
 - controls 328
- L**
- Labs
 - Advanced Motion Lab 13
 - Materials Lab 13
- Landing objects 218
 - defined 374
 - icon 233
- Landscapes 91
 - creating 92
 - filtering 107
- Lattices
 - wireframe mode 71
- Launch state 25
- Left view 21
- Library
 - adding pictures to 85
- Light Editor
 - Picture Library and 85
- Lighting 278
- Lighting Lab 278
- Lights
 - adjusting color 279
 - adjusting edges 279
 - adjusting intensity 279
 - creating 275
 - deleting settings 285
 - falloff 280
 - gels 284
 - gradient 280
 - linking 285
 - overview 274
 - parallel lights 277

- preview options 278
 - radial 276
 - round parallel 276
 - saving settings 285
 - setting up 275
 - shadow ambience 279
 - shadow softness 279
 - spotlight 276
 - square spotlights 277
 - tracking 285
 - viewing 274
 - visible 275, 282
 - volumetric world 270
- LightWave file format 364
- Lines
 - erasing 24
- Link icon 89, 231
- Linking
 - camera 348
 - geometric paths 225
 - objects to paths 89
 - propagate 225
 - to view, defined 374
- Linking objects 221, 223
 - editing attributes 236
 - lights 285
 - options 225
- Linking tab 68
- Links menu 368
 - modifying 368
- Lists, pictures 88
- Load button 82
- Loading
 - pictures 112
 - pictures into library 85
- Localized fog 250
- Location
 - defined 374
- Locked 234
 - object 234
- Locked button 234
- Logical groups 226
- LWO or LWS file formats 364
- M**
- Make circular option 237
- Make one shot option 237
- Make pendulum option 237
- Make repeat option 237
- Manually Positioning the Camera 297
- Mapping
 - defined 374
- Mapping color
 - to terrain canvas 113
- Marker Pen tool 24
 - erasing lines 24
- Masks 84
- Materials 127
 - alpha channels 133
 - animating 343, 350
 - animating between 353
 - channels, defined 374
 - components 132, 144
 - defined 374
 - editor 13
 - grid, defined 374
 - icon 232
 - pictures as 83
 - structure 128
 - surface material channels 128, 133
 - surface shading modes 156
 - volume 13
 - volume material channels 130, 142
 - volume shading modes 157
- Materials Lab
 - displaying 232
 - overview 13
 - Picture Library and 85
- Matrices
 - defined 374
- Maximize
 - windows 26
- Maximum
 - paintbrush behavior 107
- Memory dots
 - camera positions 299
 - defined 375
- Menu bar 12
- Merge command 19
- Merging
 - scenes 19
- Mesh
 - exporting 239
- Meshes
 - smoothing 238
- Metaballs 81
 - defined 375
- Metallicity 138, 142
 - setting using a texture 138
- Minimum
 - paintbrush behavior 107
- Modes
 - bitmap 26
 - camera 291
 - center to selection 292
 - display 26
 - Flat Shaded Preview mode 27
 - free 292
 - preview render 310
 - switching 27
 - trackball 291
 - tripod 292
 - wireframe 26
 - wireframe/bitmap 26
- Modifier keys 6
- Moon
 - animating 356
 - brightness/sharpness 265
 - phases 265
 - positioning 264
 - rings 266
 - size 267
 - working with 263
- Mosaic
 - terrain effect 103
- Motion paths
 - align options 237
 - converting to geometric path 89
 - display options 236
 - editing attributes 237
 - geometry options 237
- Mounds
 - terrain effect 103
- MOV files 311, 364

- Moving
 - palettes 12
- N**
- Naming
 - objects 69, 233
- Nano-edit mode 208
- Nano-editor
 - defined 375
- Nano-Preview 9, 71
 - Full Scene mode 20
 - Sky Only mode 20
 - using 23
 - Wireframe Only mode 20
- Nano-preview
 - Auto Update mode 20
 - defined 375
- Negative boolean 74, 234
- Network render client
 - defined 375
- Network render server
 - defined 375
- Network rendering 312
 - Bryce Lightning, installing 313
 - Bryce Lightning, uninstalling 313
 - cancelling 315
 - configuring the server 313
 - defined 375
 - how it works 312
 - IP address 313
 - monitoring 314
 - options 314
 - pausing 314
 - resuming 315
- Neutral
 - boolean 72, 233
- New command 18
- Noise
 - auto-phased 182
 - difference 182
 - displaced max 183
 - irregular 181
 - maximum 181
 - maximum 90 182
 - minimum 182
- minimum 90 182
- modes 181
- more irregular 181
- multifractal 181
- multiply 182
- octaves 180
- standard 181
- with rotation 182
- Nudging 216
- Numerical
 - alignment 220
 - panning 23
 - positioning camera 296
 - repositioning 215
 - resizing 211
 - rotation 213
 - zooming 22
- O**
- Object attributes
 - camera 289
 - dialog 230
 - editing 230
 - icons 230
- Object Attributes dialog 68, 345
- Object hierarchies 201, 221
 - expanding/collapsing 223
 - families 226
 - grouping 225
 - linking 223
 - viewing 222
- Object space 202
 - coordinates 205
 - defined 375
- Objects
 - adding preset objects 75
 - adding to a selection 66
 - aligning 216
 - alpha channels 82
 - arranging 33
 - as boxes 23
 - as wireframes 23
 - attributes 230
 - changing display 22
 - converting 239
 - deleting Preset objects 76
 - deselecting 66
 - editing 229
 - hiding 234
 - hierarchies 221
 - importing 89, 364
 - intersecting 74
 - linking 223
 - linking to paths 89
 - locking 234
 - materials 127
 - mesh 239
 - metaballs 81
 - names 233
 - naming 69
 - negative 74
 - origin points 207
 - placement 25, 65
 - positioning 214
 - preview 70
 - preview modes 70
 - randomizing 220
 - resizing 208
 - restoring 230
 - rotating 212
 - selecting
 - by family 67
 - by type 66
 - hidden 66
 - shadows 70
 - statistics 10
 - stones 80
 - subtracting 74
 - tracking 344
 - transforming 206
 - types, defined 375
 - VCR controls and 67
 - wireframe attributes 27
- Offset 375
- OK and Cancel 32
- OK icon 32
- Opacity
 - defined 375
- Open command 18
- Open List button 88
- OpenGL accelerator card 71
- Opening

- files 18
- Pictures Lists 88
- Operations, Boolean 73
- Optics channels 130
 - reflection 141
 - refraction 141
 - transparency 139
- Orbits
 - creating 349
- Orientation
 - defined 375
 - tracking option 236
- Origin points 207
 - camera 297
 - setting camera point 296
 - showing 234
- Orthogonal
 - defined 375
 - projection 22
- Orthogonal Views 288, 290
 - overview 21
 - using in animations 346
- Output
 - alpha 173
 - bump 173
 - color 172
 - resolution,defined 375
 - types 172
- Outputs
 - textures 172
- Overview
 - Bryce 17
- P**
- Paintbrush
 - applying locally 106
 - behaviors 106
 - modifying behavior 107
 - painting 106
 - removing locally 106
- Painting
 - a render area 304
 - elevations 106
 - erosions 107
- Palettes
 - Advanced Display palette 11

- Create palette 10
 - displaying 12, 29
- Edit palette 11
 - hiding 29
 - moving 12
 - resetting 29
- Selection palette 11, 66
- Sky & Fog palette 11
 - sky and fog 242
- tools 10
- Panning 23
 - numerically 23
- Panoramas
 - creating 361
- Paper
 - backgrounds 28
- Parallel light
 - defined 375
- Parallel lights 277
- Partial render 304
- Pasting
 - Alpha channel information 87
 - pictures 86
 - RGB information 87
- Patch rendering 316
 - defined 375
- Paths
 - converting 89
 - linking to objects 89
- PGM file format 364
- Phase 183
 - creating 184
 - dimensions 184
 - frequency 185
 - noise modes 186
 - noise octaves 186
 - noise orientation 186
 - noise type 185
- Phases
 - moon 265
- Photoshop file format 364
- Pict file format 364
 - saving 25
- Pict mapping
 - defined 376
- Pict Object tool 82

- Pict objects
 - alpha channels 82
 - creating 81
- Picture
 - terrain effect 100
- Picture Library 84
 - accessing 85
 - adding pictures 86
 - displaying pictures 85
- Picture Lists 88
 - opening 88
 - saving 88
- Pictures
 - adding to Library 85
 - adding to Picture Library 86
 - as gels 83
 - as material 83
 - as terrains 111
 - blending 112
 - copying 86, 112
 - deleting 87
 - dialog 82
 - displaying 85
 - lists 88
 - loading 112
 - pasting 86
 - previewing 85
 - terrain editor tab 111
 - thumbnails 85
 - working with 83
- Pitch
 - defined 376
- Placement
 - objects 25, 65
- Planes
 - ground 77, 78
 - infinite slabs 79
 - water 77
- Plop-render
 - defined 376
- Plop-Render mode 303
 - enabling/disabling 303
- Polygons
 - defined 376
- Polyhedrons
 - defined 375

- Polymesh objects
 - selecting 67
 - Portable Greyscale Map file format 364
 - Positioning
 - animating 356
 - camera 9, 32
 - lights 285
 - moon 264
 - objects 214
 - sun 260
 - the camera, numerically 296
 - the view of your scene 291
 - Positive boolean 234
 - Post production 363
 - compositing 365
 - Posterize
 - terrain effect 103
 - Preferences
 - Working window 26
 - Preferences command 25
 - Preset Materials Library
 - overview 15
 - Preset Object Library 75
 - Preset objects
 - adding 75
 - deleting 76
 - exporting 76
 - importing 76
 - using 75
 - Preset Objects Library
 - overview 15
 - Preset Skies Library
 - overview 15
 - Presets
 - adding skies 270
 - deleting skies 270
 - exporting skies 271
 - importing skies 271
 - resolution 18
 - skies 270
 - terrain filtering 110
 - Preview
 - applying filtering changes 110
 - Nano-Preview 9
 - Preview controls
 - animation 327
 - Preview modes
 - Bounding Box 70
 - Rendered Preview 71
 - Shaded Preview 71
 - Preview render modes 310
 - fast preview 310
 - spray rendering 304
 - textures on/off 311
 - Previewing
 - Advanced Motion Lab 338
 - from different angles 20
 - lights
 - Render Against Neutral 279
 - Render In Scene 279
 - material animations 354
 - modes 70
 - objects 70
 - pictures 85
 - Sky Lab changes 243
 - terrain animations 360
 - texture components 198
 - thumbnails 85
 - Primitives 64
 - creating 65
 - defined 376
 - derivative 65
 - Printing
 - images 368
 - Procedural objects 64
 - defined 376
 - Propagate
 - linking option 236
 - options 225
 - PSD file format 364
 - Pyramids
 - creating 65
- ## Q
- QTVR Panorama Movies
 - file format 364
 - Quality/Speed 144
 - Quick render 304
 - QuickTime VR 361
 - creating movies 369
 - creating panoramas 361
 - in Bryce 3D 361
 - Quit command 25
- ## R
- Radial light 276
 - creating 277
 - defined 376
 - Rainbows 267
 - animating 356
 - Raise Edges
 - terrain effect 105
 - Raise/Lower
 - terrain effect 100
 - Randomize tool 207, 220
 - Randomizing
 - objects 220
 - skies 245
 - texture components 199
 - using randomize tool 220
 - RayDream Studio file format 365
 - Raytracing 302
 - defined 376
 - rendering 302
 - RDS file format 365
 - Redo command 24
 - Reflection 141
 - setting using a texture 142
 - Refraction 141
 - defined 376
 - Relative coordinates 206
 - defined 376
 - Relief Noise
 - terrain effect 104
 - Render button 22, 26
 - Render Controls 10, 302
 - Render Movie dialog 311
 - Render quality mode
 - default 305
 - premium 306
 - regular 305
 - super 305
 - Render reporting 308
 - Render resolution 18, 306
 - defined 377
 - Render to Disk 364
 - Render With Neutral Sky option

- 75
- Rendered Preview preview mode 71
- Rendering 301, 302
 - batch 315
 - controls 10, 302
 - defined 376
 - fast rendering strategies 315
 - images 316
 - movies 311
 - network rendering 312
 - plop-render mode 303
 - post processing options 307
 - premium effects 306
 - projection types 308
 - quality mode options 305
 - raytracing 302
 - resuming 304
 - setting up 305
 - spray rendering 304
- Rendering algorithms 307
- Rendering optimization
 - aggressive 307
 - minimal 307
 - normal 307
- Reposition tool 207, 214
- Repositioning objects
 - interactively 215
 - nudging 216
 - numerically 215
 - using reposition tool 214
- Reset Palettes command 29
- Resetting
 - views 21
 - zoom values 23
- Resize tool 207, 208
- Resizing objects 208
 - interactively 211
 - numerically 211
 - using resize tool 209
 - using the keyboard 212
- Resolution
 - documents 18
 - preset value 18
 - render 18
 - rendering 306
 - setting 96
 - wireframes 28
- Resolution tool 28
- Restoring objects 230
- Revert to Saved command 24
- RGB images
 - creating 87
 - pasting 87
 - replacing information 86
 - viewing 85
- Right view 21
- Roll
 - defined 377
- Rotate tool 207, 212
- Rotating objects 212
 - interactively 213
 - numerically 213
 - using rotate tool 212
- Rotation
 - defined 377
- Round Edges
 - terrain effect 101
- Round parallel light 276
- S**
- Save As 364
- Save As command 25
- Save command 25
- Save List button 88
- Saving
 - files 25
 - light settings 285
 - Pictures Lists 88
 - preferences 25
 - terrains 115
 - textures 199
- Saving camera positions 299
- Sawtooth
 - terrain effect 104
- Scale
 - defined 377
- Scaling
 - rendered images 316
- Scenes
 - creating 18
 - defined 377
 - displaying 19
 - merging 19
 - rendering 301, 302
 - viewing 21
- Select All command 66, 67
- Select by Type icons 66, 67
- Select Color command 29
- Selecting
 - background color 29
 - background texture 28
 - hidden objects 66
 - objects
 - by family 67
 - by type 66
 - VCR controls 67
 - Polymesh objects 67
 - within groups 66
- Selection
 - adding objects to 66
 - deleting objects from 66
- Selection palette 11, 66
 - displaying 66
- Sequencer 335
- Setting
 - display modes 26
 - display preferences 25
 - Working window preferences 26
- Setting Palette Options 244
- Setting up
 - lights 275
 - rendering 305
- Shaded Preview preview mode 71
- Shadow 279
- Shadows 70
 - control 246
 - setting intensity 247
 - skies 246
- shadows
 - ambience 279
 - edges 279
- Sharpening
 - terrain effect 100
- Sharpness
 - moon 265
- Show always option 236

- Show as box 234
- Show as Box button 234
- Show as ribbon option 237
- Show handles 237
- Show Object as Box command 23, 71
- Show Object as Lattice command 23, 71
- Show origin point 234
- Show tangents option 237
- Show trajectory option 236
- Show when selected option 236
- Size
 - defined 377
- Skies
 - adding fog 248
 - adding haze 248
 - ambient color 248
 - and camera motion 346
 - animating 343, 354
 - animating clouds 355
 - clouds 253
 - environmental effects 266, 267, 268
 - fog 248
 - haze 251
 - preset library 270, 271
 - randomizing 245
 - shadows 246
 - sky attributes 246
 - sky dome color 257
 - Sky Lab 243
 - sky modes 245
 - sun 260
 - sunrise 261
 - sunset 261
- Sky and Fog palette 11, 242
 - ambient color 248
 - animating settings 355
 - attributes 246
 - cloud altitude 257
 - cloud coverage 256
 - control thumbnails 244
 - day/night toggle 261
 - fog 248
 - frequency and amplitude 257
 - haze 251
 - options 244
 - positioning sun 260
 - saving settings 244
 - shadows 246
 - sky dome color 257
 - sky modes 245
 - working with 244
- Sky dome
 - color 257
 - defined 377
- Sky Lab 243
 - atmosphere tab 267, 270
 - cloud tab 254
 - color perspective 252
 - sun/moon tab 260, 263
- Sky modes 245
 - atmosphere off 246
 - darker sky 245
 - soft sky 245
- Sky Only mode 20
- Slope Noise
 - terrain effect 102
- Smoothing
 - defined 377
 - imported objects 238
 - terrain effect 100
- Snap To options 218
 - defined 377
- Soft shadows 306
- Soft sky 245
- Softening
 - filtering graph 110
- Solo Mode button 68
- Source generators
 - fractal 99
 - picture 100
- Specular
 - defined 377
- Specular color 137
 - setting using texture 137
- Specular Halo 137
 - setting using texture 138
- Specularity 136
 - setting using texture 137
- Speeding up textures 199
- Spheres
 - creating 65
- Spikes
 - terrain effect 102
- Spotlight
 - defined 377
- Spotlights 276
 - adjusting spread 279
 - creating 277
- Spray Rendering 304
- Square Edges
 - terrain effect 101
- Square spotlights 277
 - creating 277
- Star fields 268
- Static resolution 28
- Statistics
 - object 10
- Stones
 - creating 80
 - editing 238
- Stratus
 - adding 254
 - clouds 254
- Subcontours
 - terrain effect 104
- Submenus
 - displaying 12
- Subplateaus
 - terrain effect 105
- Subtracting
 - objects 74
- Subtraction
 - boolean 73
- Sun
 - animating position 356
 - color 263
 - disabling 263
 - horizon illusion 267
 - linking to camera 262
 - linking to fog 250
 - linking to haze 252
 - positioning 260
 - rings 266
 - working with 260
- Sun/Moon size 267

- Sunrise 261
- Sunset 261
- Supported file formats
 - exporting 364
 - importing 364
 - objects 364
- Surface material channels 128, 133
 - ambience 135
 - ambient color 136
 - bump height 138
 - color channels 129
 - diffuse color 134
 - diffusion 133
 - metallicity 138, 142
 - optics channels 130
 - reflection 141
 - refraction 141
 - specular color 137
 - specular halo 137
 - specularity 136
 - transparency 139
 - transparent color 140
 - value channels 130
- Surface Visible Lights 282
- Switching
 - between display modes 26
 - modes 27
 - views 20
- Symmetrical Lattice
 - defined 378
 - tool 80
- T**
- Targa file format 364
- Technical support
 - knowledge base 2
- Technical support
 - AnswerPerfect 2
 - Classic Service 2
 - FAQs 2
 - fax on demand 2
 - mail, fax, email options 3
 - newsgroups 2
 - Premium Service 3
 - Priority Service 2
- self-serve options 2
- telephone options 2
- Techniques
 - animating 343
- Terrain canvas 94
 - defined 378
- Terrain editor 93
 - 3D preview 94
 - animation controls 96
 - clipping bracket 114
 - elevation tools 99
 - exporting 115
 - features 93
 - filtering tab 109
 - overview 12
 - paintbrush behaviors 106
 - paintbrush controls 95
 - pictures tab 111
 - terrain canvas 94
 - undoing operations 97
 - zoom area 98
- Terrains 91
 - adding color 113
 - animating 343, 357
 - animating geometry 358
 - basic tools 100
 - clipping 114
 - creating 92
 - creating new 97
 - creating with pictures 111
 - defined 378
 - editing 12
 - editor 93
 - eroding 97
 - exporting 115
 - filtering 107
 - image filtering effects 102
 - inverting 97
 - previewing animations 360
 - resolution, defined 378
 - saving 115
 - speeding up 117
- Test render 304
- Text Display area 10
- Texture blend modes 192
 - add 193
 - average 193
 - blend altitude 194
 - blend maximum 193
 - blend minimum 193
 - blend orientation 194
 - blend random 194
 - blend slope 194
 - blend v1 and v2 194
 - combine 193
 - difference 194
 - fast slope 194
 - maximum 193
 - minimum 193
 - multiply 193
 - parallel 192
 - procedural blend 194
 - subtract 193
- Textures
 - background 28
 - blend modes 192
 - color blending modes 175
 - color component 174
 - combining components 192
 - component elements 174
 - component structure 171
 - component, defined 378
 - editing clouds 254
 - filtering 186
 - global changes 194
 - mapping, defined 378
 - output 172
 - output types 172
 - phase 183
 - saving 199
 - speeding up 199
 - structure 170
- Textures On/Off 311
- TGA file format 364
- Thumbnails 85
 - sky controls 244
- TIFF file format 364
- Time Dots 324
- Time Mapping Curve editor 337
- Time/Selection palette toggle 11, 66, 67, 234
- Timeline 323

- Tools
 - Cloud plane tools 78
 - Display Mode tool 26
 - elevation 99
 - Families tool 67
 - Ground plane tool 77
 - Marker Pen tool 24
 - palettes 10
 - Pict Object tool 82
 - Resolution tool 28
 - Symmetrical Lattice tool 80
 - Water plane tool 78
 - Zoom In tool 22
 - Zoom Out tool 22
 - Zoom tool 22
- Top view 21
- Toruses
 - creating 65
 - defined 378
 - editing 237
- Trackball
 - using 293
- Trackball Mode 291
- Tracking
 - camera 348
 - icon 232
- Tracking objects 344, 345
 - editing attributes 236
 - icon 231
 - lights 285
- Trajectory
 - camera 347
- Transformation tools 206
 - align tool 207, 217
 - randomize tool 207, 220
 - reposition tool 207, 214
 - resize tool 207, 208
 - rotate tool 207, 212
- Transforming objects 206
 - aligning 216
 - flipping 210
 - nano-edit mode 208
 - origin point 207
 - positioning 214
 - randomizing 220
 - resizing 208
 - rotating 212
 - tools 206
- Transparency 139
 - defined 378
 - gradient lights 282
 - setting using texture 139
- Transparent color 140
 - setting using texture 140
- Tree Lab 120
- Trees
 - branches 122
 - creating 79
 - editing 119
 - leaves 124
 - previewing 121
 - saving settings 124
 - trunks 122
- Tripod Mode 292
- True ambience 306
- TrueSpace file format 364
- Tutorial 31
- Type
 - selecting by 66
- U**
- Underground On/Off button 28
- Undo
 - terrain editor 97
- Undo command 24
- Undoing operations 24
- Union
 - boolean 73
- Unity
 - defined 378
- User guide
 - about 6
 - conventions 6
- USGS DEM file format 364
- USGS SDTS file format 364
- Using
 - Bryce Interface 29
 - Nano-Preview 23
 - Preset objects 75
- V**
- Value channels 130
 - ambience 135
 - bump height 138
 - diffusion 133
 - metallicity 138, 142
 - specularity 136
- Values
 - animating 351
- VCR Controls
 - displaying 67
- VCR controls 11, 67
- VideoScape file format 364
- View Control 9
- View control icon 23
- View of scene
 - positioning 291, 293
- View of you scene
 - setting up 288
- View of your scene 274, 288
 - banking 295
 - camera view 288
 - director's view 288
 - field of view 295
 - orthogonal views 288
 - rotating 293
 - setting up 288
- Viewing
 - lights 274
 - object hierarchies 222
 - pictures 85
 - scenes 21
- Views
 - camera view 20, 288, 289
 - defined 378
 - director's view 288, 290
 - fly-around 23
 - from back 21
 - from bottom 21
 - from front 21
 - from left 21
 - from right 21
 - from top 21
 - icon 21, 23
 - Nano-Preview 9
 - orthogonal 21
 - orthogonal views 288
 - orthogonal views 290

- panning 23
- positioning 291
- resetting 21
- swapping 290
- switching 20
- Visible lights 275, 282
 - editing material 284
 - surface 282
 - volume 282
- Volume channels 132
 - base density 143
 - edge softness 143
 - fuzzy factor 143
 - quality/speed 144
 - volume color 142
- Volume Color 142
- Volume material channels 130, 142
 - base density 143
 - edge softness 143
 - fuzzy factor 143
 - quality/speed 144
 - volume channels 132
 - volume color 142
- Volume materials 13
- Volume Visible Lights 282
- Volumetric world 270
- VRML1 file format 364
- VSA file format 364

W

- Water plane tool 78
- Water planes 77
- Web Links menu 368
 - modifying 368
- Web support 368
- Windows
 - backgrounds 28
 - Bryce 8
 - maximizing 26
 - paper texture 28
 - setting up 25
 - Working window 8, 26
- Wireframe mode
 - attributes 27
- Wireframe Only mode
 - Nano-Preview and 20
- Wireframe Shadows button 28
- Wireframe/Bitmap display mode 26
- Wireframes
 - defined 378
 - depth cue 27
 - displaying 26
 - displaying objects as 23
 - motion resolution 28
 - preview 70
 - resolution 28
 - resolution, defined 378
 - selected resolution 28
 - shadows 28
 - static resolution 28
 - underground 28
- Working window 8
 - setting up 26
- World space 202
 - defined 378
- WRL file format 364

X

- X-Y Camera control 293
- X-Z Camera control 293

Y

- Yaw
 - defined 378
- Y-Z Camera control 293

Z

- Zoom area
 - moving 98
 - resizing 98
 - terrains 98
 - turning on 98
- Zoom In tool 22
- Zoom Out tool 22
- Zoom tool 22
- Zooming
 - in 22
 - numerically 22
 - out 22
 - resetting values 23